

*intercable*

## Datasheet Aluminium Verbinders 800mm<sup>2</sup> rm/sm, -mm<sup>2</sup> se 10 – 30kV

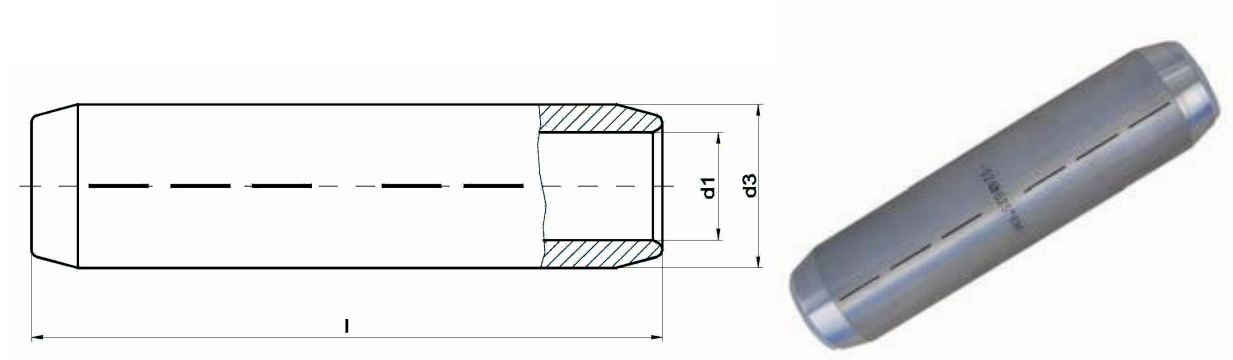

<b>Artikelnummer</b>	ICAL800V30
<b>Doorsnede kabel</b>	
Rond/Sector meerdradig	800mm <sup>2</sup>
Sector enkeldradig	-mm <sup>2</sup>
<b>Materiaal</b>	Al 99,5
<b>Afwerking</b>	Blank, met contactvet gevuld, gesloten
<b>Referentienummer (kengetal) t.b.v. matrijsnummer)</b>	58

### Maten:

<b>D1</b>	40
<b>D3</b>	58
<b>L</b>	235
<b>Gewicht</b>	87.5kg/100