

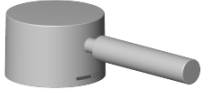















**Handle for washstand deck mounting Lever 52 x 35 x 117 mm - Champagne  
(22kt Gold)**

SPARE PARTS

90 20 66 002 00 Product version from 4/1/2025



	Champagne (22kt Gold)	90 20 66 002 00-47
	Chrome	90 20 66 002 00-00
	Brushed Platinum	90 20 66 002 00-06
	Platinum	90 20 66 002 00-08
	Dark Chrome	90 20 66 002 00-19
	Light Gold (PVD)	90 20 66 002 00-26
	Brushed Light Gold (PVD)	90 20 66 002 00-27
	Brushed Durabrass (23kt Gold)	90 20 66 002 00-28
	Matte Black	90 20 66 002 00-33
	Brushed Gold (PVD)	90 20 66 002 00-37
	Brushed Dark Brass (PVD)	90 20 66 002 00-39
	Brushed Bronze (PVD)	90 20 66 002 00-42
	Brushed Champagne (22kt Gold)	90 20 66 002 00-46
	Brushed Chrome	90 20 66 002 00-93
	Brushed Dark Platinum	90 20 66 002 00-99



Handle for washstand deck mounting Lever 52 x 35 x 117 mm - Champagne  
(22kt Gold)

---

SPARE PARTS

90 20 66 002 00 Product version from 4/1/2025



Handle for washstand deck mounting Lever 52 x 35 x 117 mm - Champagne  
(22kt Gold)

---

SPARE PARTS

90 20 66 002 00 Product version from 4/1/2025

90 20 66 002 00 Product version from 4/1/2025

Parts for other  
finishes can be found  
here: Chrome

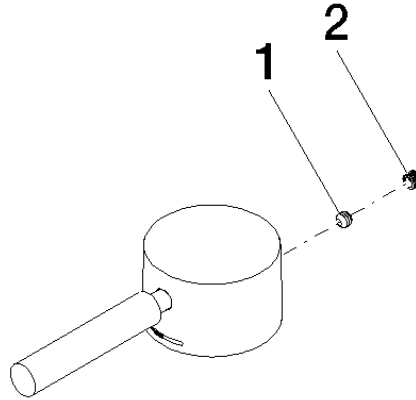

### Spare parts list

No.	Item Number	Name	Quantity used	Delivery time
2	90 31 20 109 00 90	Plug -	1.00	14
1	90 31 11 063 00 90	Mounting Threaded pin with hexagon socket with cup point M5 x 4 mm -	1.00	14