

Data Sheet | Item Number: 870-523/281-587

Component terminal block; double-deck; with varistor; for DIN-rail 35 x 15 and 35 x 7.5; 2.5 mm²; CAGE CLAMP®; gray

<https://www.wago.com/870-523/281-587>

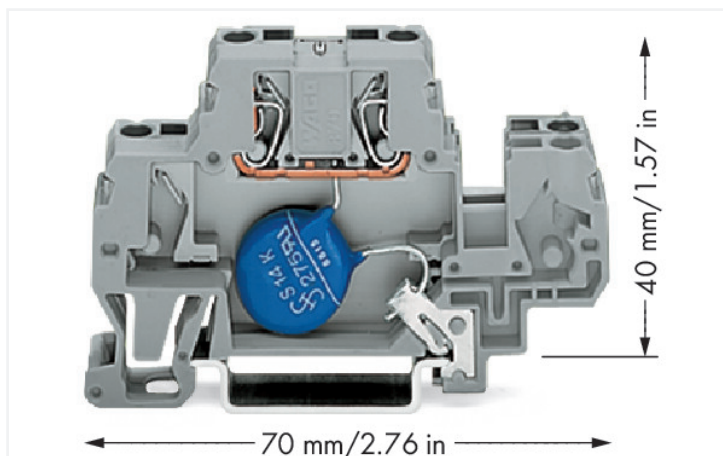

Color: ■ gray

Similar to illustration

Similar to illustration

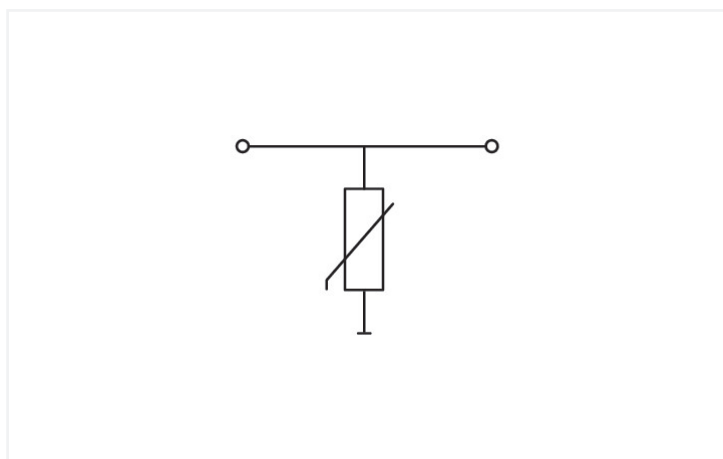

Notes

Safety Information

- Installation must be performed by qualified personnel only.
- The DIN-rail must be grounded.
- The input current must be protected by a suitable fuse.
- Protection against contact with stored charges must be ensured.
- Do not insert or remove pluggable modules when energized.
- The IP20 protection rating must be maintained in the assembled state or when using an end/intermediate plate compatible with the rail-mount terminal block.

Electrical data

Nominal operating voltage	115 VAC
Maximum continuous voltage	150 VAC
Rated continuous current	20 A
Nominal discharge current (8/20 µs) (line)	1 kA
Discharge current (max.)	4.5 kA
Protection level (8/20 µs)	≤ 395 VAC
Capacitance	≤ 570 pF

Connection Data

Connections (number)	2
Connection technology	CAGE CLAMP®
Solid conductor	0.08 ... 2.5 mm ² / 28 ... 14 AWG
Fine-stranded conductor	0.08 ... 4 mm ² / 28 ... 12 AWG
Fine-stranded conductor; with insulated ferrule	0.08 ... 1.5 mm ² / 28 ... 14 AWG
Strip length	6 ... 7 mm / 0.24 ... 0.28 inches

Physical data

Width	10 mm / 0.394 inches
Height	70 mm / 2.756 inches
Depth from upper-edge of DIN-rail	40 mm / 1.575 inches

Mechanical data

Mounting type	DIN-35 rail
---------------	-------------

Material data

Color	gray
Insulation material (main housing)	Polyamide (PA66)
Material group	I
Flammability class per UL94	V0
Fire load	0.259 MJ
Weight	12.2 g

Environmental requirements

Processing temperature	-35 ... +85 °C
------------------------	----------------

Commercial data

Product Group	16 (Rail Mounted Terminal Blocks with CCC)
PU (SPU)	25 pcs
Packaging type	Box
Country of origin	DE
GTIN	4045454353698
Customs tariff number	85369010000

Product Classification	
UNSPSC	39121410
eCl@ss 10.0	27-14-11-27
eCl@ss 9.0	27-14-11-27
ETIM 9.0	EC000903
ETIM 10.0	EC000903
ECCN	NO US CLASSIFICATION

Environmental Product Compliance	
RoHS Compliance Status	Compliant, No Exemption

Downloads

Environmental Product Compliance

Compliance Search	
Environmental Product Compliance 870-523/281-587	↓

Documentation

Bid Text			
870-523/281-587	19.02.2019	xml 3.38 KB	↓
870-523/281-587	11.02.2015	doc 26.00 KB	↓

CAD/CAE-Data

CAD data	
2D/3D Models 870-523/281-587	↓

CAE data	
EPLAN Data Portal 870-523/281-587	↓
WSCAD Universe 870-523/281-587	↓
ZUKEN Portal 870-523/281-587	↓

1 Compatible Products

1.1 Optional Accessories

1.1.1 End plate

1.1.1.1 End plate



Item No.: 870-518

End and intermediate plate; 2 mm thick; gray



Item No.: 870-519

End and intermediate plate; 2 mm thick; orange

1.1.2 Insulation stop

1.1.2.1 Insulation stop



Item No.: 280-470

Insulation stop; 0.08 - 0.2 mm² "s" (0.14 mm² "f-st"); 5 pieces/strip; white



Item No.: 280-471

Insulation stop; 0.25 - 0.5 mm²; 5 pieces/strip; light gray



Item No.: 280-472

Insulation stop; 0.75 - 1 mm²; 5 pieces/strip; black

1.1.3 Jumper

1.1.3.1 Jumper



Item No.: 280-492

Jumper; 2-way; insulated; gray

1.1.4 Marking

1.1.4.1 Marker



Item No.: 2009-145

Mini-WSB InLine; for Smart Printer; 1700 pieces on roll; stretchable 5 - 5.2 mm; plain; snap-on type; white



Item No.: 248-501

Mini-WSB marking card; as card; not stretchable; plain; snap-on type; white

1.1.5 Tool

1.1.5.1 Operating tool



Item No.: 210-720

Operating tool; Blade: 3.5 x 0.5 mm; with a partially insulated shaft; multicoloured