







CL.1 Wall valve clockwise closing 1/2" - Chrome

CL.1

36 617 705 Product version up to 10/14/2020



- with WAVES structure
- rosette 60 x 60 mm
- without marking
- head part with cut-to-length spindle and sleeve
- WRAS

	Chrome	36 617 705-00
	Brushed Platinum	36 617 705-06
	Dark Chrome	36 617 705-19
	Brushed Light Gold (PVD)	36 617 705-27
	Brushed Champagne (22kt Gold)	36 617 705-46
	Champagne (22kt Gold)	36 617 705-47
	Brushed Dark Platinum	36 617 705-99

Required miscellaneous



- Wall valve 1/2" -** 35 607 970 90
- min. recess depth 105 mm
 - max. recess depth 150 mm

36 617 705 Product version up to 10/14/2020

mm [inches]



Codes & Standards

ASME A112.18.1	cUPC	DIN 4109	EN 1111
EN 200	ISO 3822	Scottish Water Byelaws	UK Water Supply Regulations

Ü-Zeichen

Certificates and sustainability

WRAS_2011	DVGW_DW-6501DN0	DVGW_DW-6512DN0	LGA_29	WRAS_2010
LGA_29	IAPMO_4976 (EPD-DOR-20230287 -IBA1-EN Environmental.prod uct-declarat		

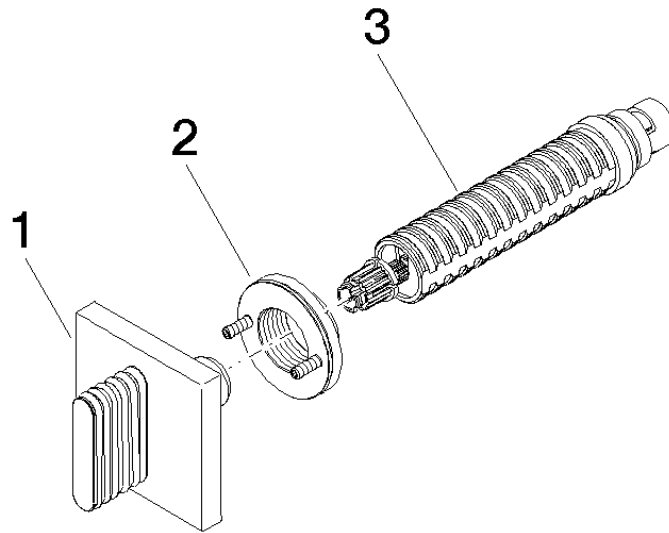

Spare parts list

No.	Item Number	Name	Quantity used	Delivery time
1	90 20 70 055 01-00	Handle for concealed wall mounting Neutral oval wave 60 x 60 x 40 mm - Chrome	1.00	20
2	90 21 02 108 00 90	Wall disc complete -	1.00	14
3	90 90 03 143 00 90	Head part clockwise closing 1/2" -	1.00	14