

Data Sheet | Item Number: 281-665/281-739

Component terminal block; 4-conductor; for DIN-rail 35 x 15 and 35 x 7.5; 4 mm²; CAGE CLAMP®; gray

<https://www.wago.com/281-665/281-739>

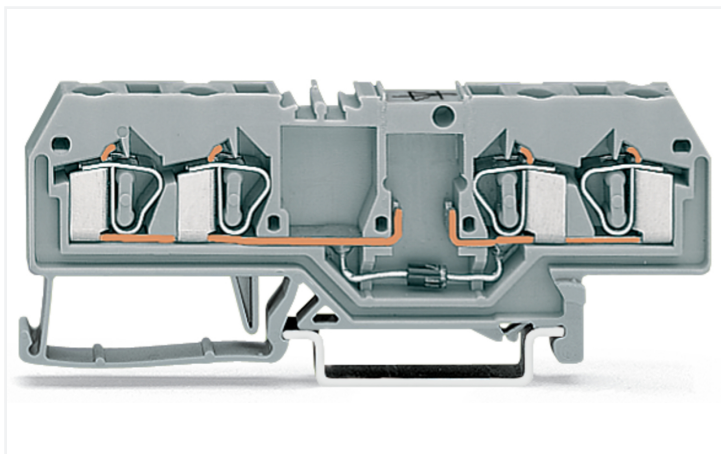

Color: ■ gray

Similar to illustration

Notes

Safety Information

- Installation must be performed by qualified personnel only.
- The DIN-rail must be grounded.
- The input current must be protected by a suitable fuse.
- Protection against contact with stored charges must be ensured.
- Do not insert or remove pluggable modules when energized.
- The IP20 protection rating must be maintained in the assembled state or when using an end/intermediate plate compatible with the rail-mount terminal block.

Electrical data

Operating voltage	250 VAC
Power (max.)	0.6 W
Thermal resistance	140 K/W
Tolerance	±1 %
Resistor type/design	DIN 0207

Safety and protection

Rated impulse withstand voltage	4 kV
Pollution degree	3

Safety Information

- Installation must be performed by qualified personnel only.
- The DIN-rail must be grounded.
- The input current must be protected by a suitable fuse.
- Protection against contact with stored charges must be ensured.
- Do not insert or remove pluggable modules when energized.
- The IP20 protection rating must be maintained in the assembled state or when using an end/intermediate plate compatible with the rail-mount terminal block.

Protection type	IP20
-----------------	------

Connection Data

Clamping units	4
Total number of potentials	1
Number of levels	1

Connection 1

Connection technology	CAGE CLAMP®
Actuation type	Operating tool
Connectable conductor materials	Copper Aluminum
Solid conductor	0.08 ... 4 mm ² / 28 ... 12 AWG
Fine-stranded conductor	0.08 ... 4 mm ² / 28 ... 12 AWG
Strip length	9 ... 10 mm / 0.35 ... 0.39 inches

Physical data

Width	6 mm / 0.236 inches
Height	86 mm / 3.386 inches
Depth from upper-edge of DIN-rail	29 mm / 1.142 inches

Material data

Color	gray
Insulation material (main housing)	Polyamide (PA66)
Material group	I
Flammability class per UL94	V0
Fire load	0.216 MJ
Weight	13.5 g

Environmental requirements

Ambient temperature (operation)	-25 ... +70 °C
---------------------------------	----------------

Standards and Specifications

Standards/specifications	EN 60947-7-1 EN 60664-1 EN 60566
--------------------------	--

Commercial data

Product Group	1 (Rail Mounted Terminal Blocks)
PU (SPU)	50 pcs
Packaging type	Box
Country of origin	DE
GTIN	4045454197575
Customs tariff number	85369010000

Product Classification

UNSPSC	39121410
ETIM 9.0	EC000903
ETIM 10.0	EC000903
ECCN	NO US CLASSIFICATION

Environmental Product Compliance

RoHS Compliance Status

Compliant, No Exemption

Approvals / Certificates

Declarations of conformity and manufacturer's declarations

Approval	Standard	Certificate Name
EU-Declaration of Conformity WAGO GmbH & Co. KG	-	-
UK-Declaration of Conformity WAGO GmbH & Co. KG	-	-

Downloads

Environmental Product Compliance

Compliance Search

Environmental Product Compliance
281-665/281-739

