

2TMD042300D0013 | 13.10.2023

# Product manual

## ABB-Welcome

### M2247.-W Video Indoor Station 4.3 Handset

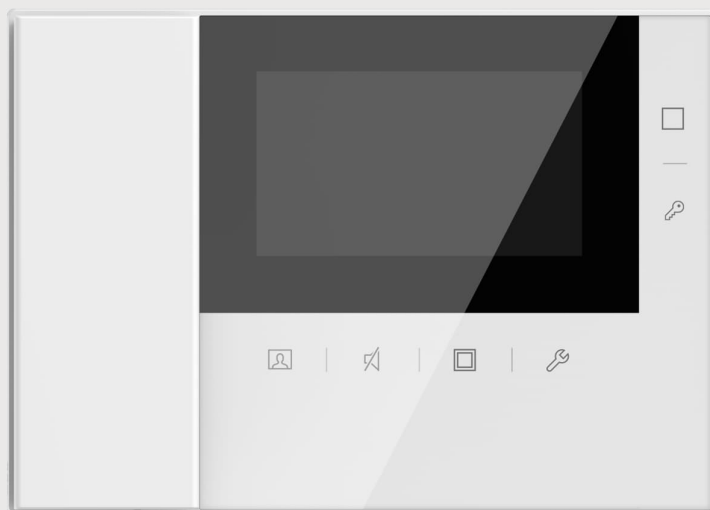

## Table of contents

1	Notes on the instruction manual .....	4
2	Safety .....	4
3	Intended use .....	4
4	Environment .....	5
4.1	ABB devices .....	5
5	Product description .....	6
5.1	Device type .....	6
5.2	Control elements .....	7
5.3	Terminal description .....	9
6	Technical data .....	10
7	Mounting/Installation .....	11
7.1	Requirement for the electrician .....	11
7.2	General installation instructions .....	12
7.3	Mounting .....	13
7.3.1	Installation height .....	13
7.3.2	Surface-mounted installation .....	13
7.3.3	Desktop installation .....	15
7.3.4	Dismantling .....	15
8	Commissioning .....	16
8.1	Operating instructions .....	16
8.2	Initial setup .....	17
9	Operation .....	22
9.1	Incoming call .....	22
9.1.1	Incoming call from Outdoor Station .....	22
9.1.2	Incoming call from Indoor Station/Guard Unit .....	26
9.2	Surveillance .....	28
9.3	Intercom .....	30
9.4	Program button .....	31
9.5	History .....	32
9.5.1	Accessing the "History" screen .....	32
9.5.2	Displaying history records .....	33
9.5.3	Removing history records .....	35
10	Setting .....	37
10.1	Camera list .....	37
10.1.1	Accessing the "Camera list" screen .....	37
10.1.2	Creating a camera list .....	38
10.1.3	Renaming the camera .....	39
10.1.4	Previewing the camera .....	41
10.1.5	Visual doorbell setting .....	43
10.1.6	Removing the camera .....	45

10.2	Program button settings .....	46
10.2.1	Accessing the "Program button" screen .....	46
10.2.2	Adding a program function .....	47
10.2.3	Removing the program function .....	49
10.3	Intercom settings .....	50
10.3.1	Accessing the "Intercom list" screen .....	50
10.3.2	Adding an intercom .....	51
10.3.3	Removing the intercom .....	53
10.4	Audio settings .....	54
10.4.1	Accessing the "Audio settings" screen .....	54
10.4.2	Setting the feedback tone .....	55
10.4.3	Setting the ringtone volume .....	56
10.4.4	Setting the ringtone type .....	57
10.4.5	Setting the missed call .....	58
10.5	Unlock password .....	59
10.6	Date and time settings .....	61
10.7	Display settings .....	62
10.8	Language setting .....	63
10.9	About .....	64
10.10	Restoring to factory default .....	65
11	Cyber security .....	66
11.1	Disclaimer .....	66
12	Notice .....	67

## 1 Notes on the instruction manual

Please read through this manual carefully and observe the information it contains. This will assist you in preventing injuries and damage to property and ensure both reliable operation and a long service life for the device.

Please keep this manual in a safe place. If you pass the device on, also pass on this manual along with it. ABB accepts no liability for any failure to observe the instructions in this manual.

## 2 Safety



### Warning

Electric voltage!

Dangerous currents flow through the body when coming into direct or indirect contact with live components.

This can result in electric shock, burns or even death.

- Disconnect the mains power supply prior to installation and/or disassembly!
- Permit work on the 100-240 V supply system to be performed only by specialist staff!

## 3 Intended use

This device is an integral part of the ABB-Welcome door communication system and operates exclusively with components from this system. The device must only be installed in dry indoor rooms.

### Cleaning



### Caution

Risk of damage to the screen surface

The screen surface can be damaged by hard or sharp objects!

Never use such objects for entries on the touch screen monitor.

- Use your finger or a plastic stylus.

The screen surface can be damaged by cleaning fluids or abrasive agents!

- Clean the surfaces using a soft cloth and commercially available glass cleaner.

- Never use abrasive cleaning agents.

## 4 Environment



### **Consider the protection of the environment!**

Used electric and electronic devices must not be disposed of with household waste.

- The device contains valuable raw materials that can be recycled. Therefore, dispose of the device at the appropriate collecting facility.

### **4.1 ABB devices**

All packaging materials and devices from ABB bear the markings and test seals for proper disposal. Always dispose of the packing materials and electric devices and their components via an authorized collection facility or disposal company.

ABB products meet the legal requirements, in particular the laws governing electronic and electrical devices and the REACH ordinance.

(EU-Directive 2012/19/EU WEEE and 2011/65/EU RoHS)

(EU-REACH ordinance and law for the implementation of the ordinance (EG) No.1907/2006)

## 5 Product description

### 5.1 Device type

Article number	Product ID	Product name	Colour	Size (mm)
M22473-W	2TMA220051W0001	Video Indoor Station 4.3 Handset (T-Loop)	White	206 x 147 x 44.2
M22471-W	2TMA220051W0002	Video Indoor Station 4.3 Handset	White	206 x 147 x 44.2

5.2 Control elements

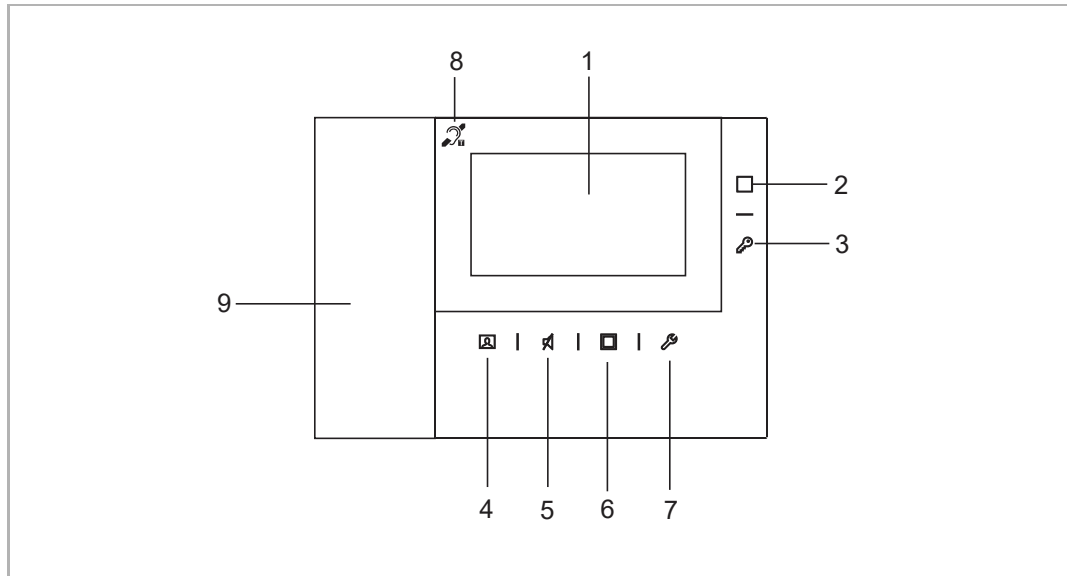

No.	Description
1	<b>4.3" colour display</b>
2	<p><b>Unlock button 2</b></p> <ul style="list-style-type: none"> <li>▪ In standby status, press to release the 2nd lock of the default Outdoor Station.</li> <li>▪ During a call request or communication, press to release the 2nd lock of the Outdoor Station which is calling.</li> <li>▪ During surveillance, press to release the 2nd lock of the Outdoor Station which is under surveillance.</li> </ul>
3	<p><b>Unlock button</b></p> <ul style="list-style-type: none"> <li>▪ In standby status, press to release the default lock of default Outdoor Station. Long press 3 seconds to enable/disable the “Auto unlock” function on the primary Indoor Station.</li> <li>▪ During a call request or communication, press to release the default lock of the Outdoor Station which is calling.</li> <li>▪ During surveillance, press to release the default lock of the Outdoor Station which is under surveillance.</li> </ul>
4	<p><b>Surveillance button</b></p> <ul style="list-style-type: none"> <li>▪ In standby status, press to monitor the default Outdoor Station.</li> <li>▪ During a call request, if “One on” mode is used on the (mini) system controller, only the primary Indoor Station can show the image, for the secondary Indoor Station this button needs to be pressed to obtain the image.</li> <li>▪ During communication, long press to take a snapshot.</li> <li>▪ During surveillance, press to switch to the next video stream or terminate the surveillance.</li> </ul> <p><b>Mute button</b></p> <ul style="list-style-type: none"> <li>▪ In standby status, press to activate/mute the ringtone.</li> <li>▪ In standby status, long press to mute the ringtone of all Indoor Stations in the same apartment.</li> <li>▪ During a call request, press to activate/mute the ringtone and the call will be terminated after 5 s.</li> <li>▪ During communication, press to activate/mute the microphone.</li> </ul>

6	<p><b>Program button</b></p> <ul style="list-style-type: none"> <li>▪ In standby status, press to release the 2nd lock of the default Outdoor Station by default. If multiple functions are set to the program button, press to access the “Program button” screen.</li> </ul>
7	<p><b>Setting button</b></p> <ul style="list-style-type: none"> <li>▪ In standby status, press to enter the system settings.</li> <li>▪ During a call request, communication, or surveillance, press to set the volume, colour, contrast and brightness.</li> </ul>
8	<p><b>*Induction loop function</b></p>
9	<p><b>Handset</b></p> <ul style="list-style-type: none"> <li>▪ During a call request, pick up the handset within 30 seconds to accept the call.</li> <li>▪ During communication, hang up the handset to terminate the call.</li> </ul>

\* The function only applies to M22473-W. It is used for hearing-impaired persons. They can wear a hearing aid to hear the voice from the Outdoor Station or the Indoor Station.



### 5.3 Terminal description

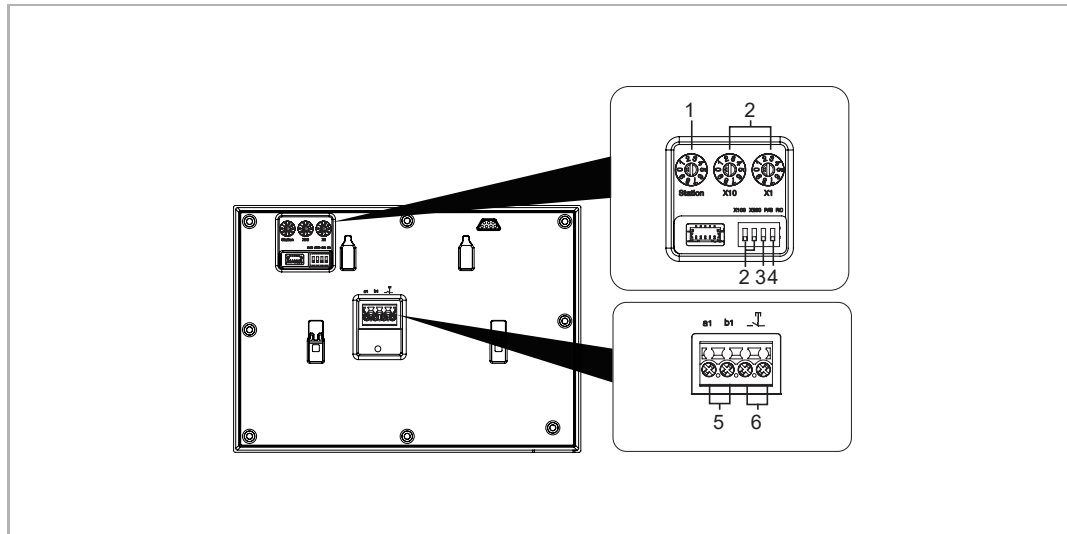

No.	Description
1	<b>Default Outdoor Station address</b> Adjust the jumper connector to set the address of the default Outdoor Station (1-9).
2	<b>Indoor Station selector switch</b> Selector switch X10 sets tens digits, selector switch X1 sets units digits, Dip switches X100 and X200 set hundreds digits.
3	<b>Primary/Secondary Indoor Station</b> Only one Indoor Station in each apartment can be set to "Primary" (ON=Primary).
4	<b>Terminal resistor switch</b> In video installations or mixed audio and video installations, the switch must be set to "RC on" on the last device of the line (ON=RC on).
5	<b>a1, b1 = bus connector</b>
6	A potential free contact, such as a doorbell pushbutton

The image/audio transmission will be influenced when a conducted disturbance has occurred, this performance degradation won't affect normal use and it is considered insignificant under our product's acceptable performance definition.

## 6 Technical data

Designation	Value
Operating voltage range	20-30 V $\overline{=}$
Standby current	24 V $\overline{=}$ , 6 mA
Operating current	24 V $\overline{=}$ , 150 mA 24 V $\overline{=}$ , 200 mA (with induction loop)
Display size	4.3"
Display resolution	480 x 272 pixels
Single-wire clamps	2 x 0.28 mm <sup>2</sup> ...2 x 0.75 mm <sup>2</sup>
Fine-wire clamps	2 x 0.28 mm <sup>2</sup> ...2 x 0.75 mm <sup>2</sup>
Operating temperature	5 °C...+45 °C
Storage temperature	-20 °C...+60 °C
Size (DxHxW)	152 x 124 x 22.6 mm

## 7 Mounting/Installation



### Warning

Electric voltage!

Dangerous currents flow through the body when coming into direct or indirect contact with live components.

This can result in electric shock, burns or even death.

- Disconnect the mains power supply prior to installation and/or disassembly!
- Permit work on the 100-240 V supply system to be performed only by specialist staff!

### 7.1 Requirement for the electrician



### Warning

Electric voltage!

Install the device only if you have the necessary electrical engineering knowledge and experience.

- Incorrect installation endangers your life and that of the user of the electrical system.

- Incorrect installation can cause serious damage to property, e.g. due to fire.

The minimum necessary expert knowledge and requirements for the installation are as follows:

- Apply the "five safety rules" (DIN VDE 0105, EN 50110):
  1. Disconnect
  2. Secure against being re-connected
  3. Ensure there is no voltage
  4. Connect to earth and short-circuit
  5. Cover or barricade adjacent live parts.
- Use suitable personal protective clothing.
- Use only suitable tools and measuring devices.
- Check the type of supply network (TN system, IT system, TT system) to secure the following power supply conditions (classic connection to ground, protective grounding, necessary additional measures, etc.).

### 7.2 General installation instructions

- Terminate all branches of the wiring system via a connected bus device (e.g. indoor station, outdoor station, system device).
- Do not install the system controller directly next to the bell transformer or other power supplies (to avoid interference).
- Do not install the wires of the system bus together with 100-240 V wires.
- Do not use common cables for the connecting wires of the door openers and wires of the system bus.
- Avoid bridges between different cable types.
- Use only two wires for the system bus in a four-core or multi-core cable.
- When looping, never install the incoming and outgoing bus inside the same cable.
- Never install the internal and external bus inside the same cable.

**7.3 Mounting**

**7.3.1 Installation height**

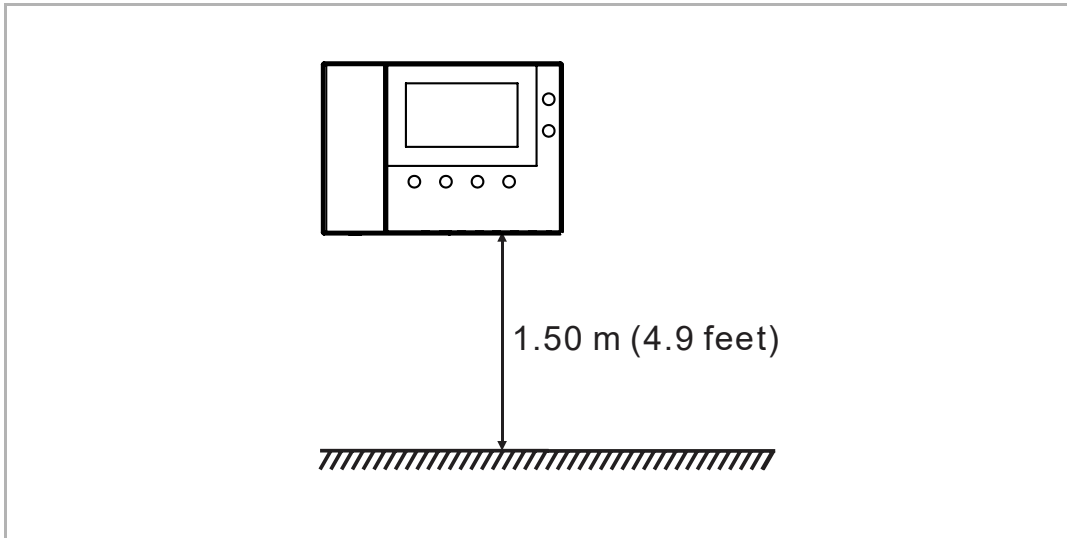

**7.3.2 Surface-mounted installation**

1. Mounting bracket size

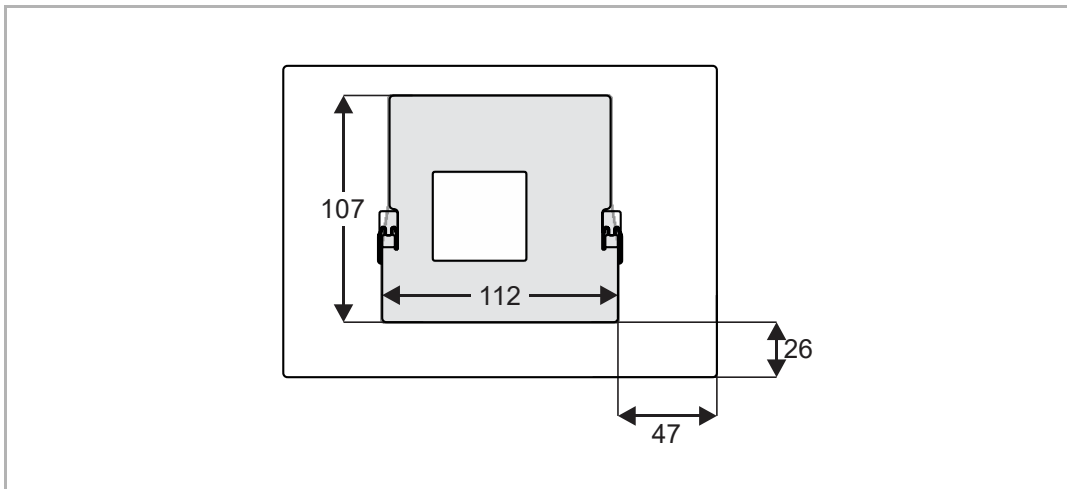

2. Surface mounted without the electrical accessory box (unit: mm)

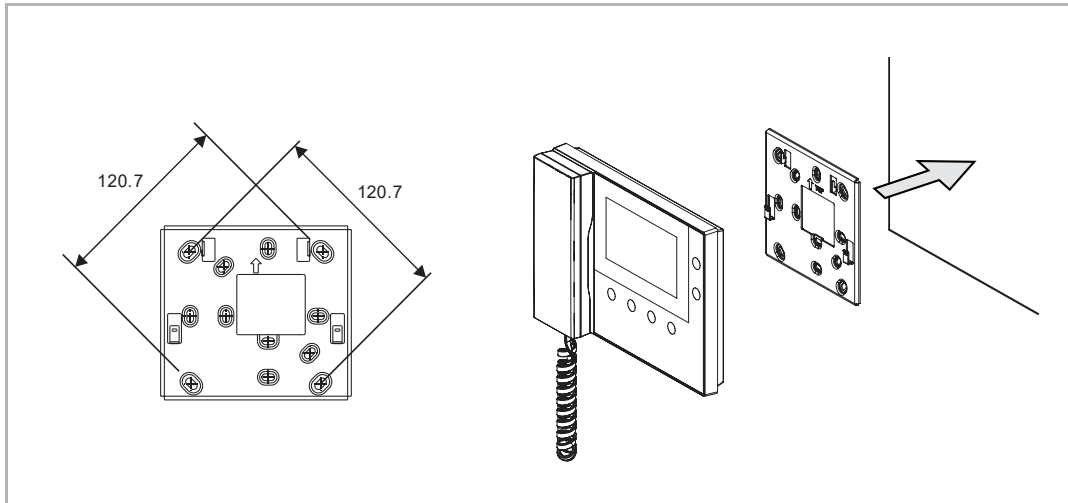

3. Surface mounted with the electrical accessory box (unit: mm)

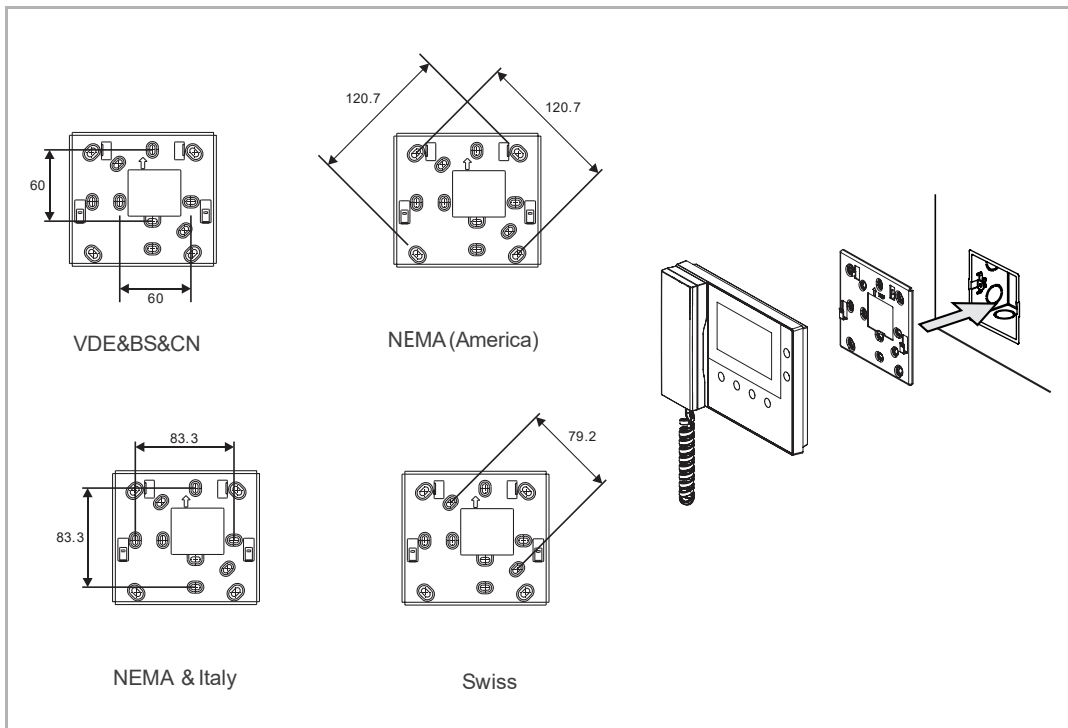

**7.3.3 Desktop installation**

(Unit: mm)

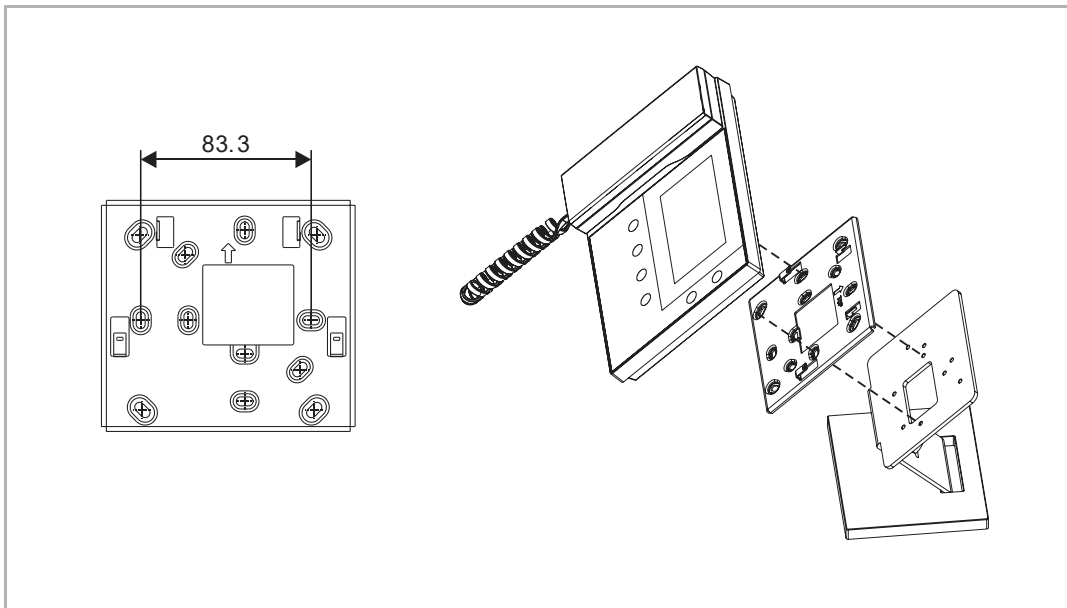

**7.3.4 Dismantling**

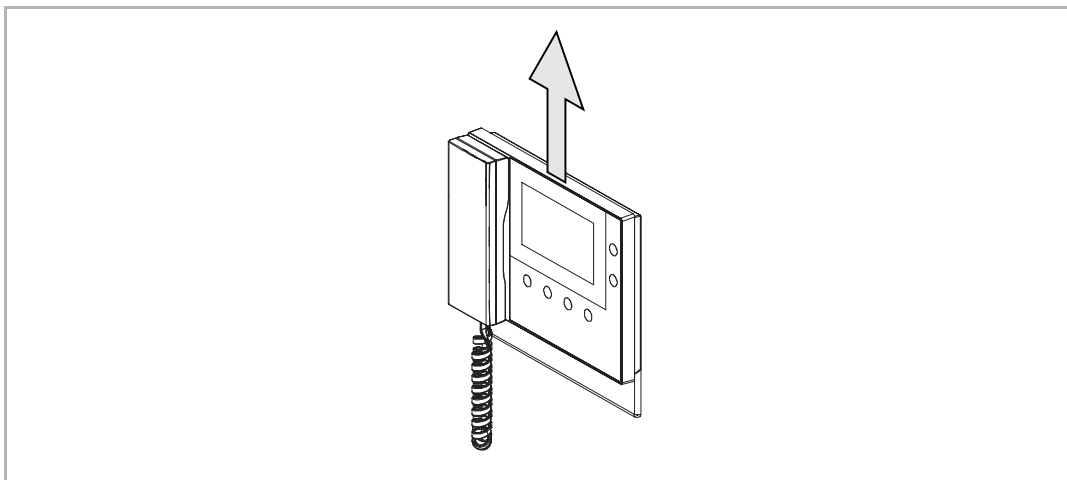

## 8 Commissioning

### 8.1 Operating instructions

Please read the rules below before use:

- To perform an operation by pressing the button below.
- To switch the selection by pressing “ ^ ” or “ v ”, the order of selection is from top to bottom and from left to right.
- To switch the number quickly by holding “ ^ ” or “ v ”.
- Press “ ✓ ” to carry out an operation like:
  - Enter the setting status
  - Confirm the update value
  - Go to next screen
- Press “ ✕ ” to carry out an operation like:
  - Exit the setting status
  - Cancel the update value
  - Go to previous screen

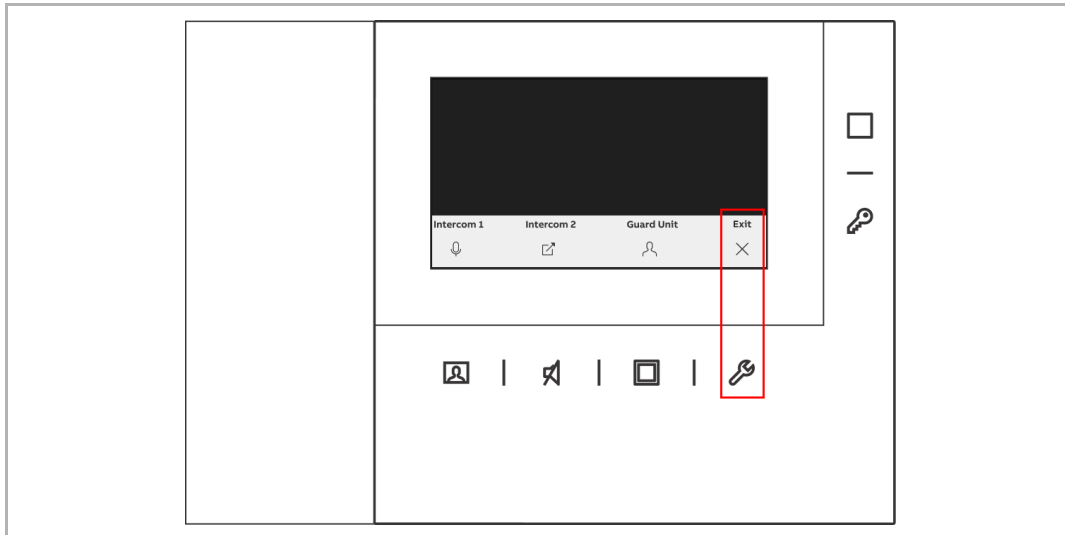



## 8.2 Initial setup

You need to carry out the initial setup the first time this Indoor Station is powered on or when this Indoor Station is reset to the factory defaults.

Please follow the steps below:

[1] Select the language

A maximum of 17 languages for selection.



[2] Show the licence agreement

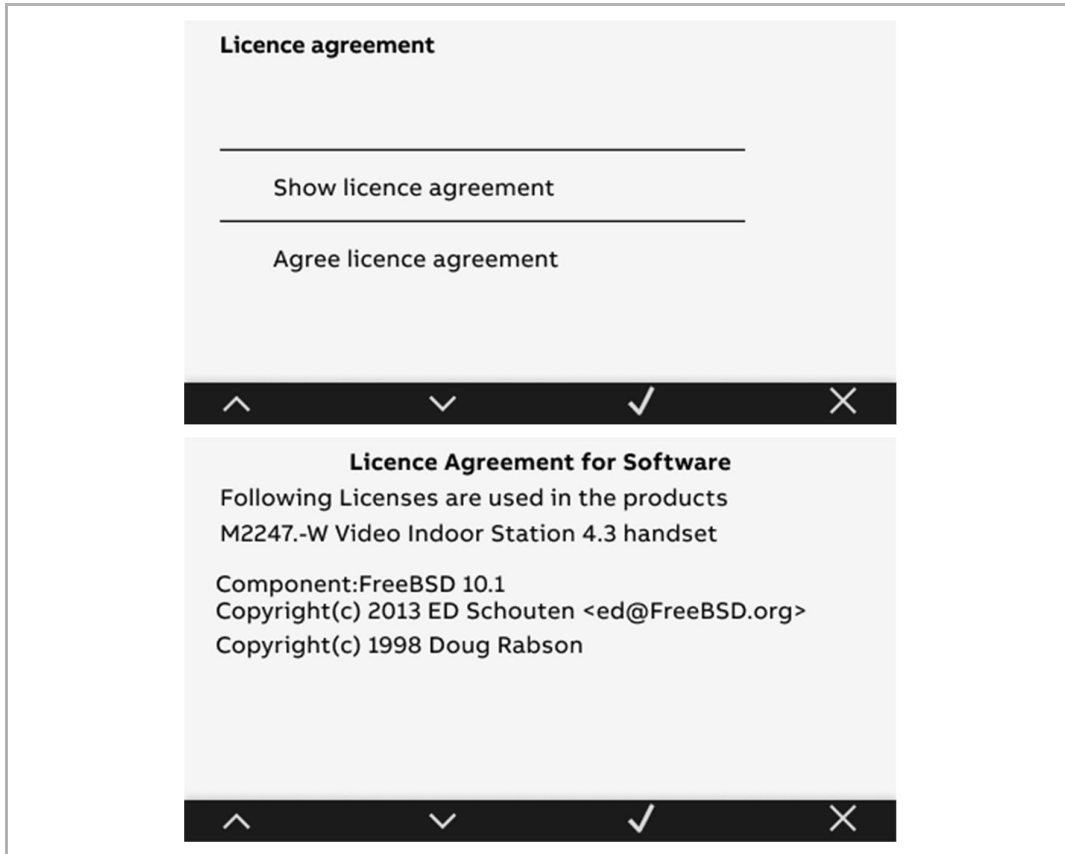

[3] Agree to the licence agreement

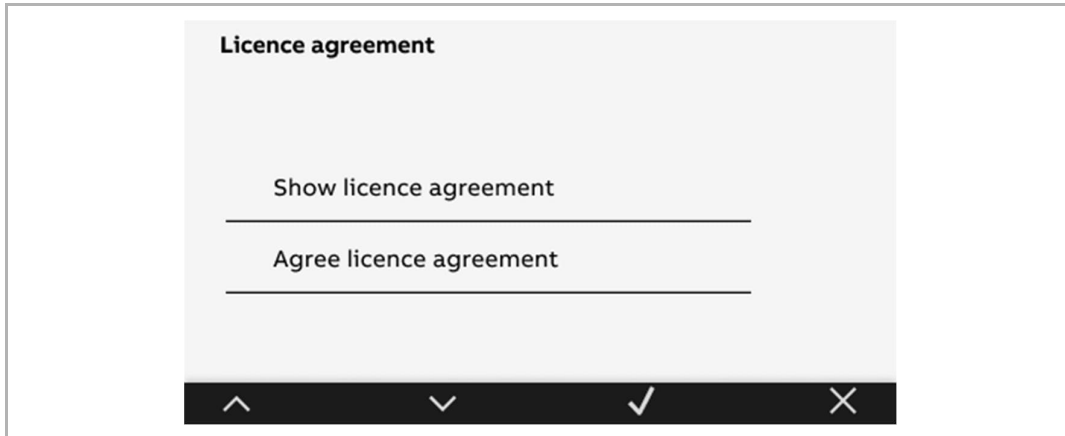

[4] Set the date and time

You can carry out this setting at this time or do it later by pressing “Next” to skip this setting.

For more details, see chapter 10.6 “Date and time settings“ on page 61.

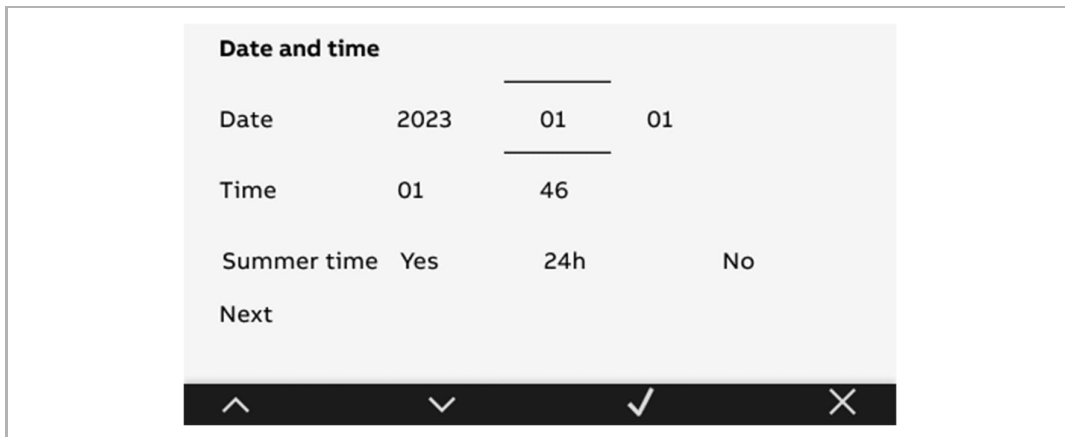

**[5] Set the camera list**

You can carry out this setting at this time or do it later by pressing “No” to skip this setting.

For more details, see chapter 10.1 “Camera list” on page 37.

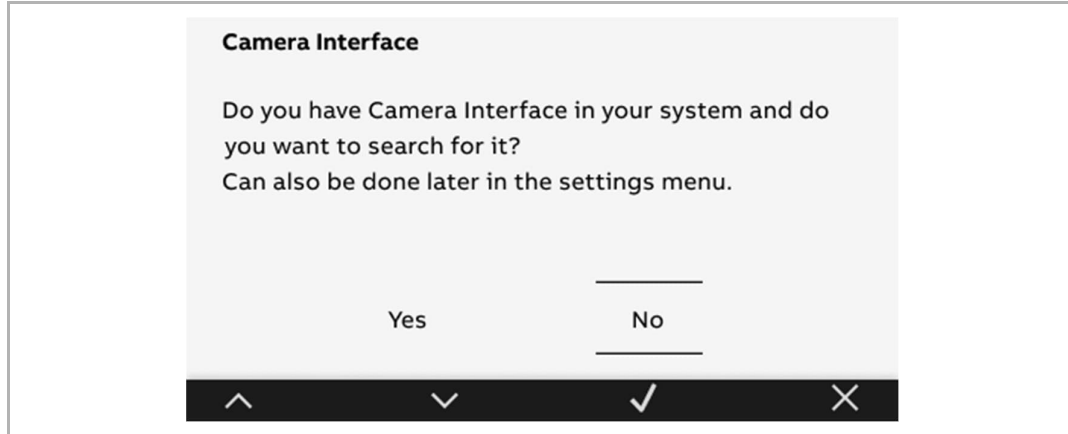
**[6] Set the program button**

You can carry out this setting at this time or do it later by pressing “No” to skip this setting.

For more details, see chapter 10.2 “Program button settings” on page 46.

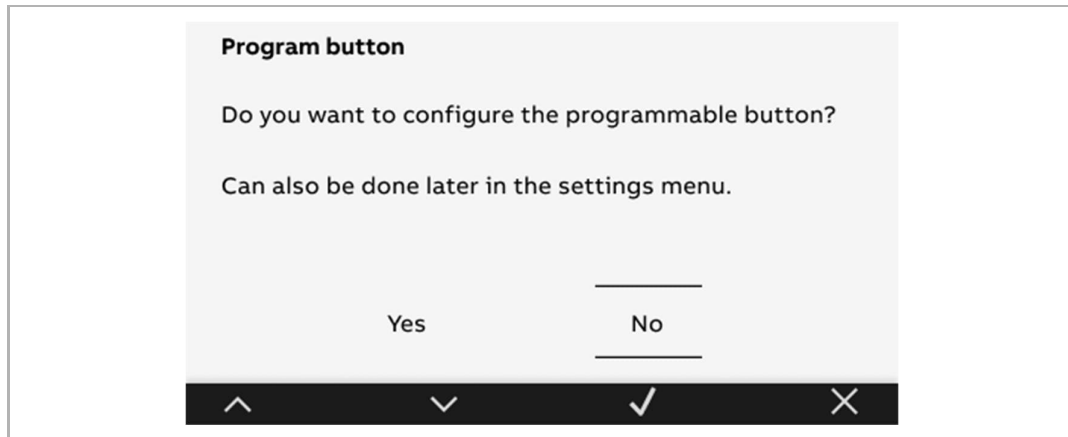

**[7] Set the intercom list**

You can carry out this setting at this time or do it later by pressing “No” to skip this setting.

For more details, see chapter 10.3 “Intercom settings” on page 50.

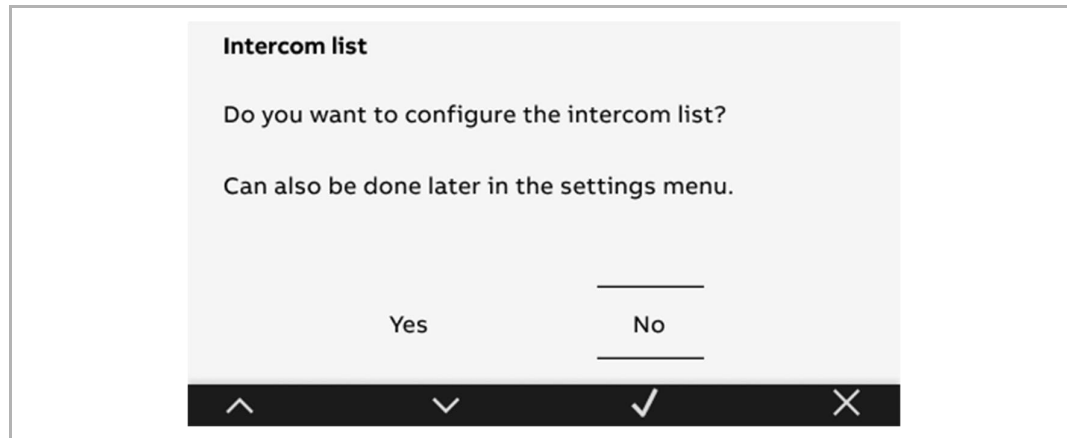
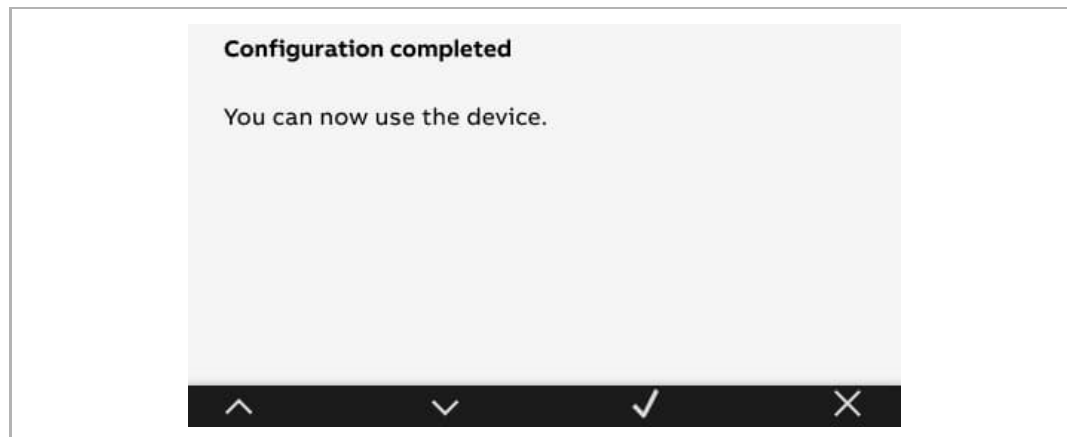
**[8] Complete the initial setup**

## 9 Operation

### 9.1 Incoming call

#### 9.1.1 Incoming call from Outdoor Station

1. Call request

- During a call request, “🔑” flashes white; pick up the handset to accept the call.
- During a call request, 2 snapshots will be taken automatically on the first second and the fifth second.

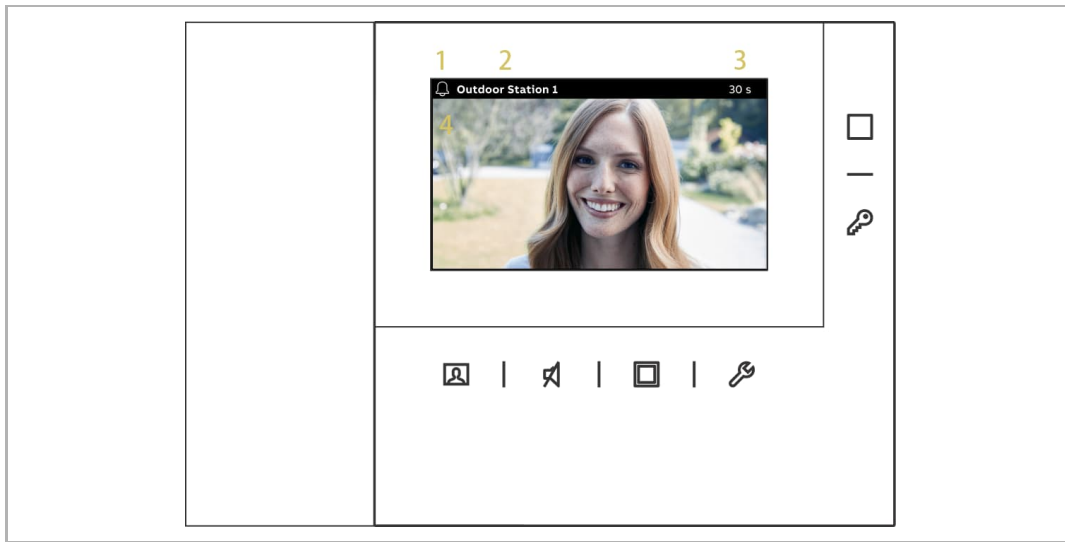

No.	Description
1	“🔔” indicates the ring status.
2	Call ID
3	Display of the remaining time (1...30 seconds) The call request will be terminated if no operation is carried out within 30 seconds.
4	Display the image from the calling Outdoor Station.



**Note**

If you want to set the ringtone for the incoming call, see chapter 10.4.4 “Setting the ringtone type” on page 57.



**Note**

During a call request, if “One on” mode is used on the (mini) system controller, only the primary Indoor Station can show the image, for the secondary Indoor Station “📷” needs to be pressed to obtain the image.

- During a call request, press “  ” to set the volume, colour, contrast and brightness.



2. Communication

- During communication, hang up the handset to terminate the call.
- During communication, long press “

The screenshot shows a communication interface with a video call in progress. The video feed displays a woman with blonde hair. Above the video feed, there are four numbered call status icons: 1 (microphone), 2 (Call ID), 3 (remaining time), and 4 (video feed). Below the video feed, there are four icons: a person icon, a microphone icon, a square icon, and a key icon. The interface also displays 'Outdoor Station 1' and '120 s'.

No.	Description
1	“  <p>Product manual 2TMD042300D0013</p>



- During communication, press “” to set the volume, colour, contrast and brightness.

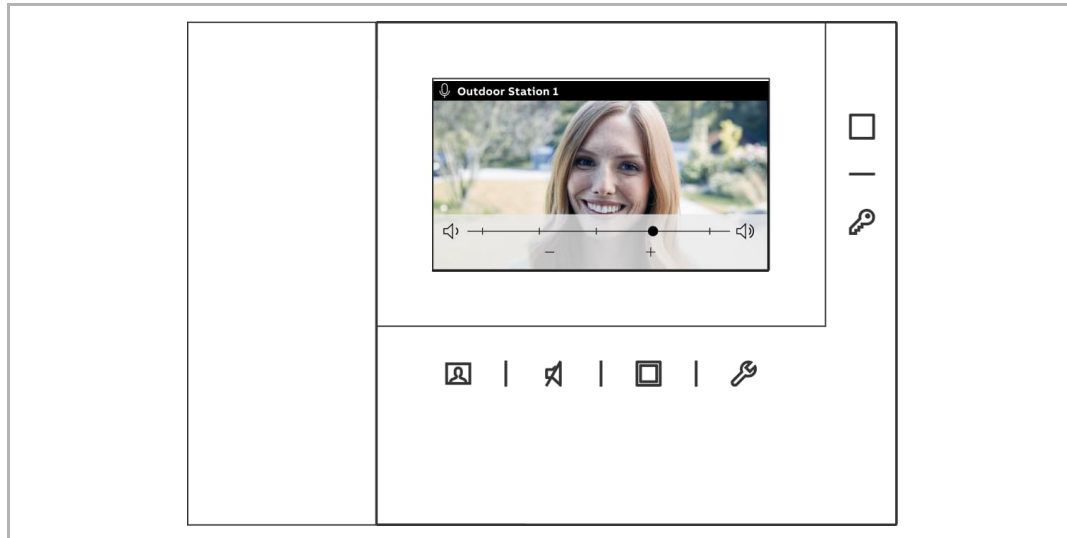

### 9.1.2 Incoming call from Indoor Station/Guard Unit

1. Call request

- During a call request, “🔑” flashes white, pick up the handset to accept the call.

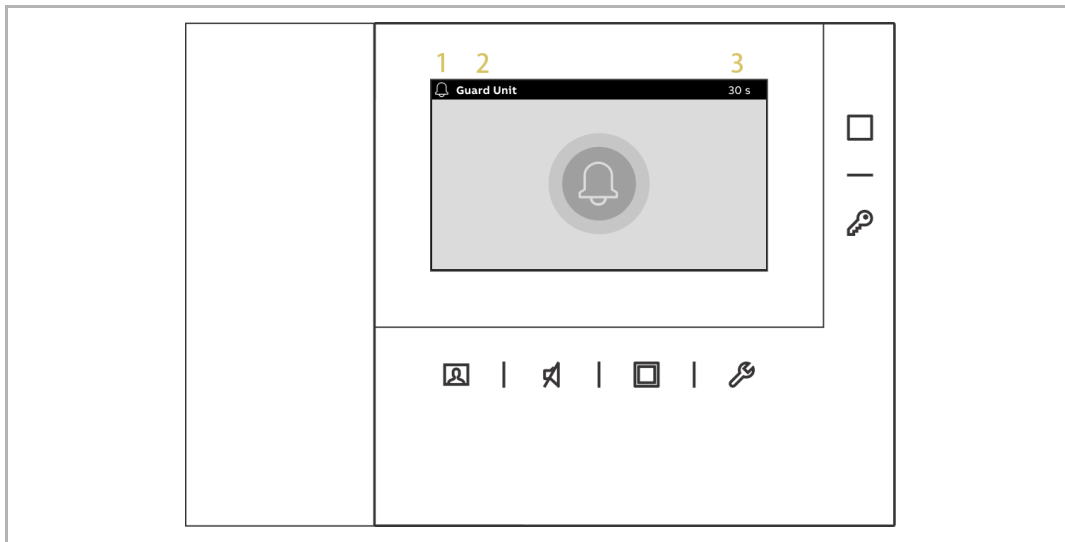

No.	Description
1	“🔔” indicates the ring status.
2	Call ID
3	Display of the remaining time (1...30 seconds) The call request will be terminated if no operation is carried out within 30 seconds.





**Note**

If you want to set the ringtone for the incoming call, see chapter 10.4.4 “Setting the ringtone type” on page 57.

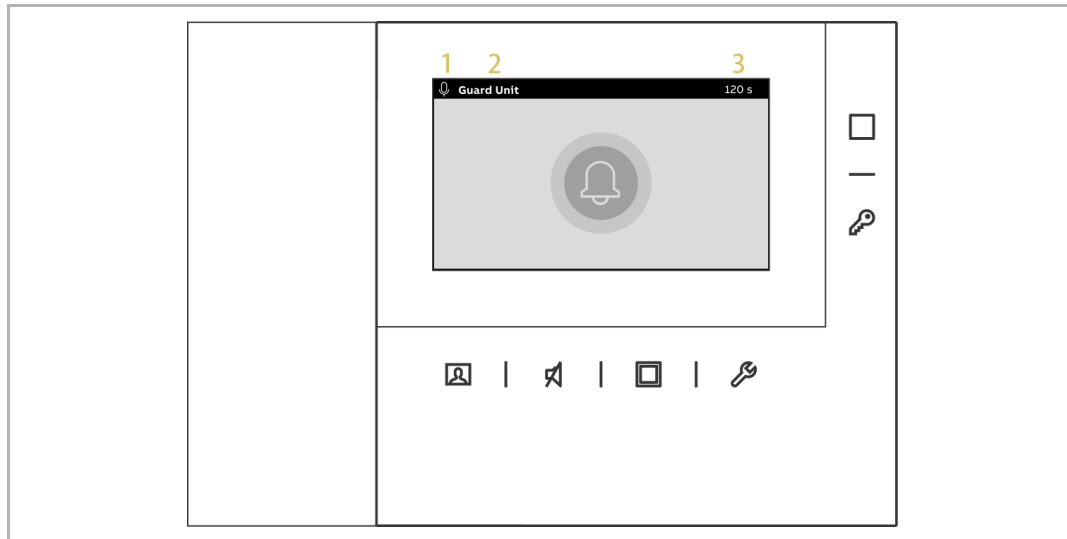

2. Communication

- During communication, hang up the handset to terminate the call.





No.	Description
1	“  ” indicates the communication status.
2	Call ID
3	Display of the remaining time (1...120 seconds)

## 9.2 Surveillance

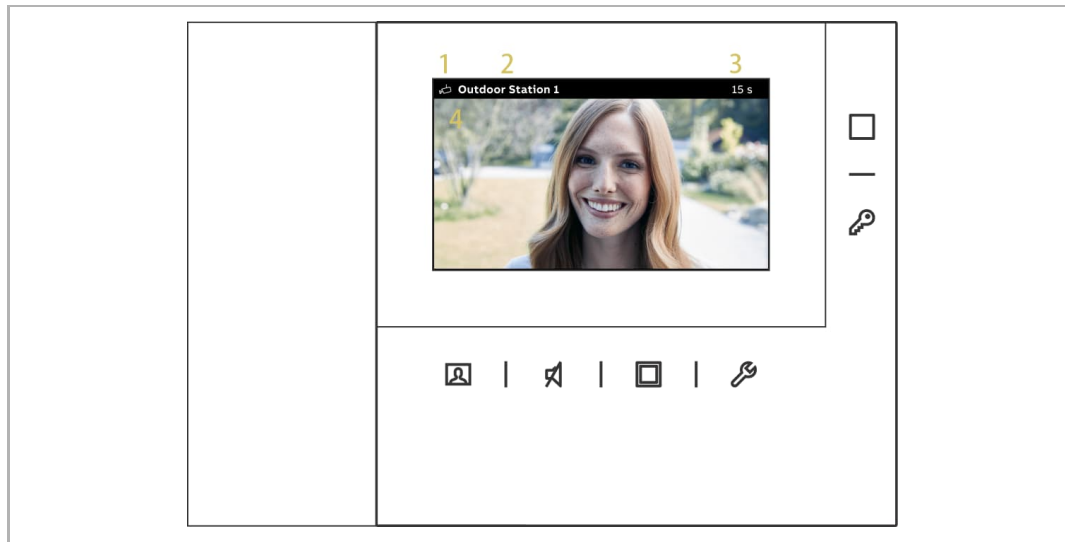
- In standby status, press “” to monitor the default Outdoor Station.
- During surveillance, pick up the handset to activate the manual call.
- During surveillance, press “” to release the default lock of the Outdoor Station which is under surveillance.
- During surveillance, press “” to switch to the next image or terminate the surveillance.



No.	Description
1	“  ” indicates the surveillance status.
2	Device ID to be monitored
3	Display of the remaining time (1...15 seconds)
4	Display the image on the default Outdoor Station.

- During surveillance, press “” to set the volume, colour, contrast and brightness.



### 9.3 Intercom

#### Precondition

An intercom list needs to be added before use. For more information, see chapter 10.3.2 “Adding an intercom” on page 51.

#### Initiating an intercom

Please follow the steps below:

- [1] In standby status, pick up the handset to access the “Intercom” screen.
- [2] Press the button below the designated intercom icon to initiate an intercom.

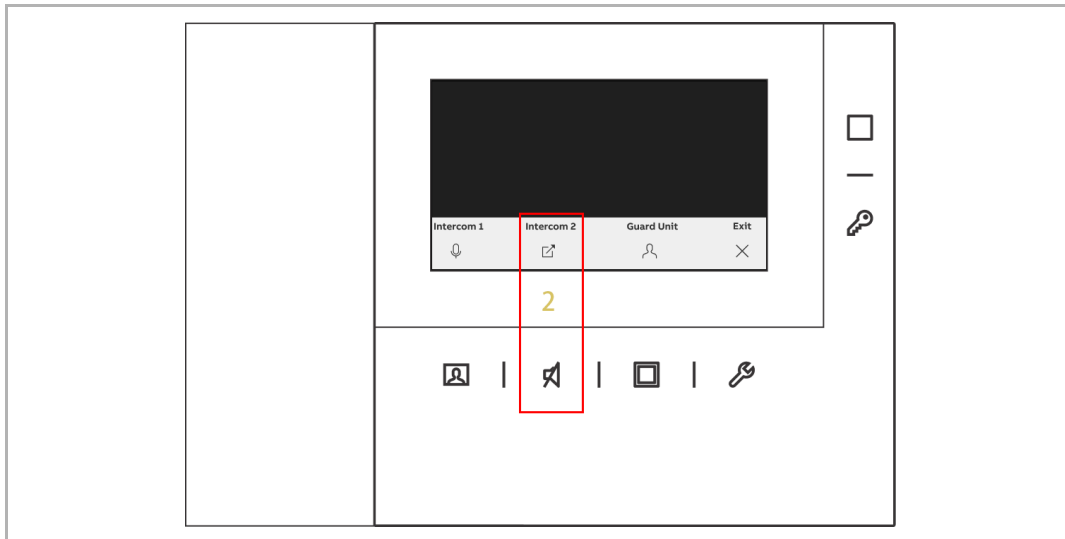

## 9.4 Program button

### Precondition

Program functions need to be set before use. For more information, see chapter 10.2.2 “Adding a program function” on page 47.

### Initiating a program function

Please follow the steps below:

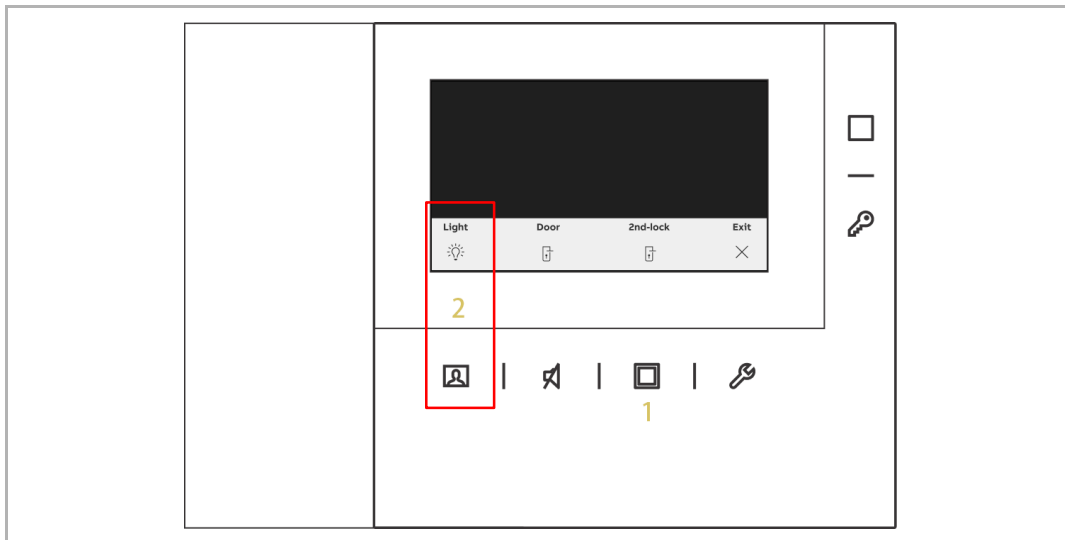

- [1] In standby status, press “” to access the “Program button” screen.
- [2] Press the button below the designated program icon to initiate a program function.



## 9.5 History

### 9.5.1 Accessing the "History" screen

Please follow the steps below:

- [1] In standby status, press “”.
- [2] Select “” on the side menu.
- [3] Press “” to access the corresponding screen.

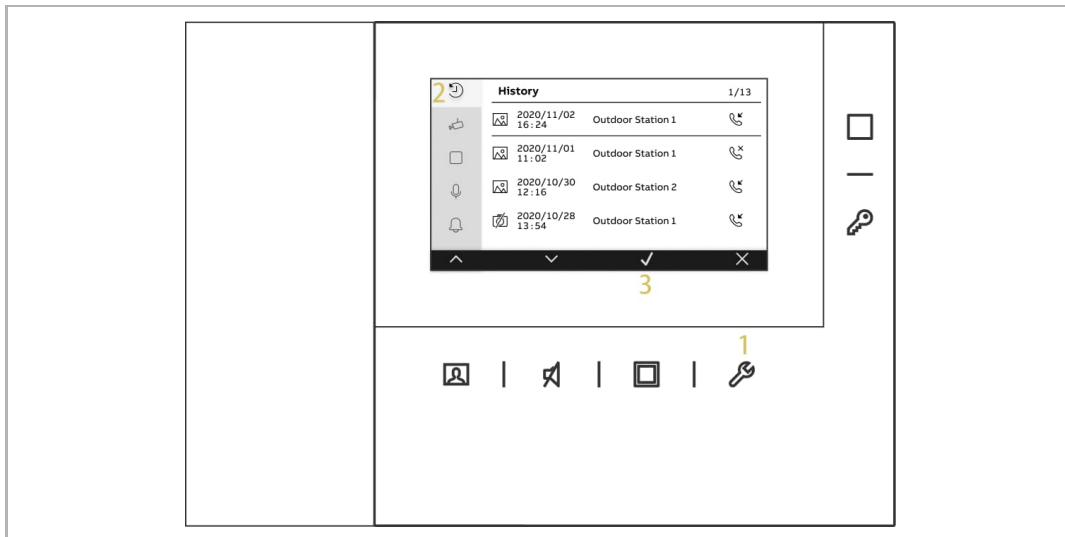









### 9.5.2 Displaying history records

Please follow the steps below:

[1] On the “History” screen, select the designated record.

- “” means the record with snapshots.
- “” means the record without snapshots.
- “” means an incoming call from the Outdoor Station or an intercom call from other Indoor Stations or the Guard Unit.
- “” means a surveillance or an intercom call to other Indoor Stations or the Guard Unit.
- “” means a missed call.

[2] Press “”.

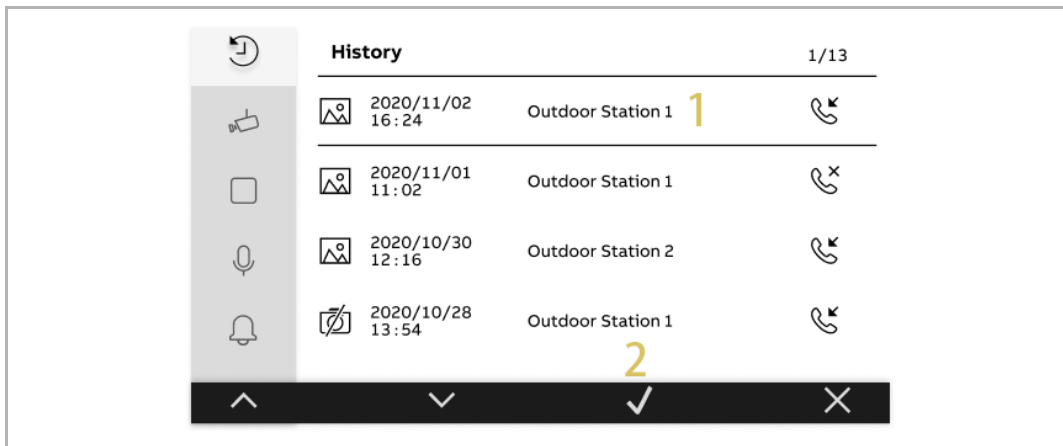

**Note**

A maximum of 100 records can be saved. Each record can include 2 snapshots and a maximum of 50 snapshots can be supported.

- [3] Display the date and time of the record.
- [4] Display the device ID.
- [5] Display the calling type.
- [6] Press “ ^ ” or “ ∨ ” to select the image.



### 9.5.3 Removing history records

Please follow the steps below:

[1] On the “History” screen, select the designated record.

[2] Press “ ✓ ”.

[3] Press “ 🗑 ”.

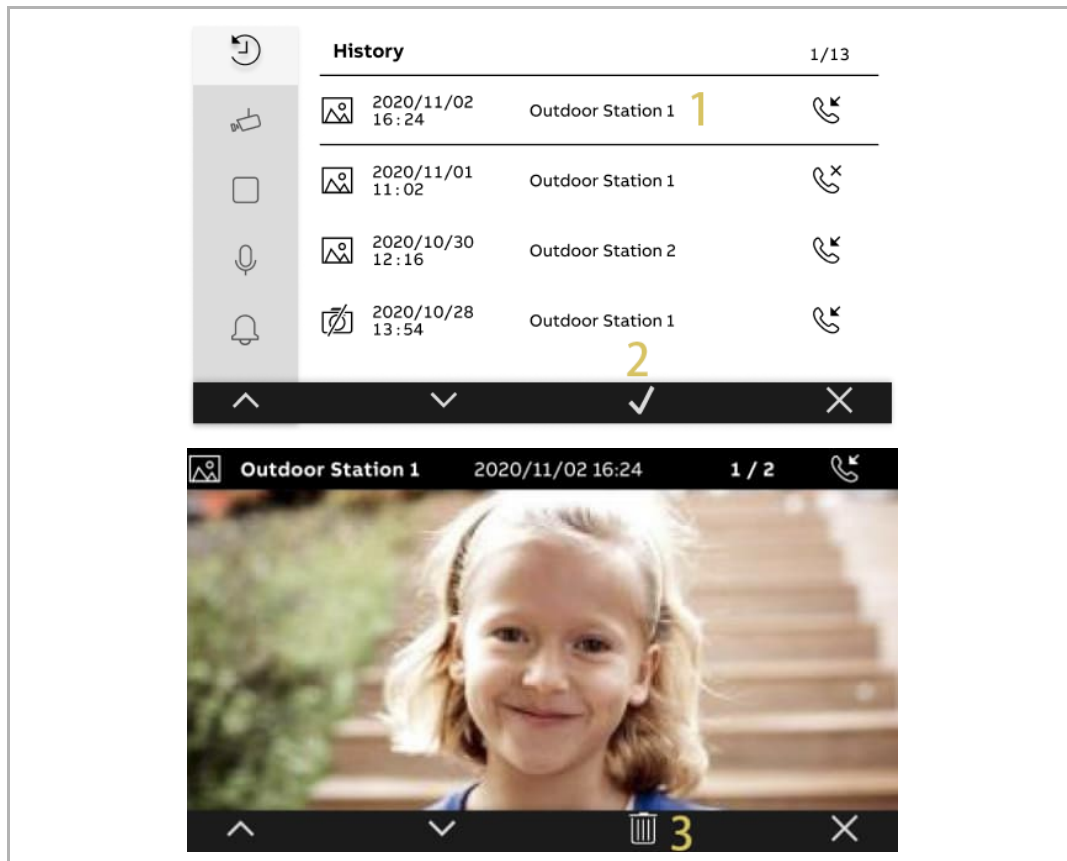

[4] Press “”.

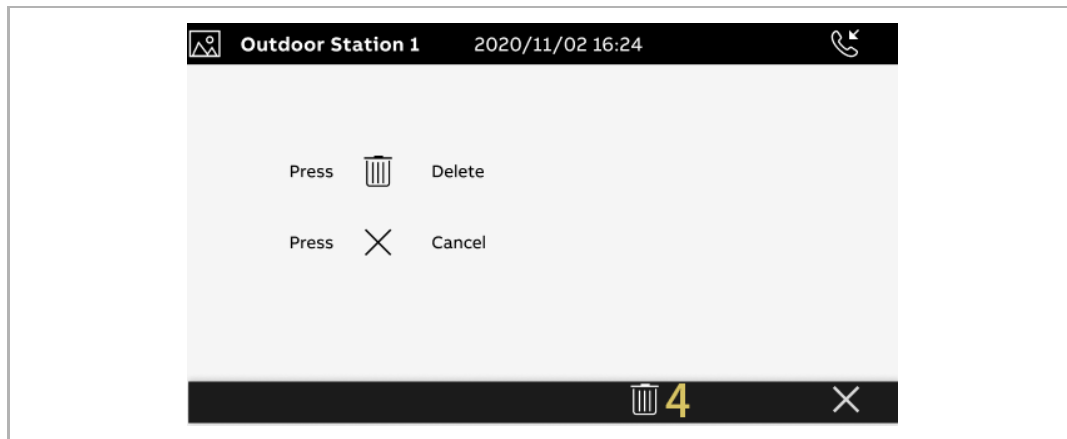



## 10 Setting

### 10.1 Camera list

#### 10.1.1 Accessing the "Camera list" screen

Please follow the steps below:

[1] In standby status, press “”.

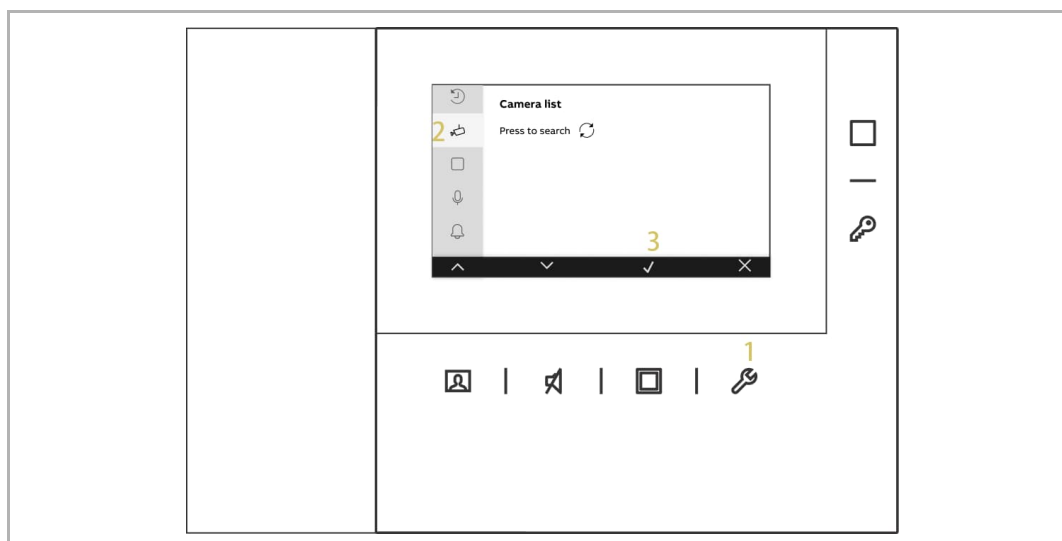

[2] Select “” on the side menu to access the corresponding screen.

[3] Select “”.

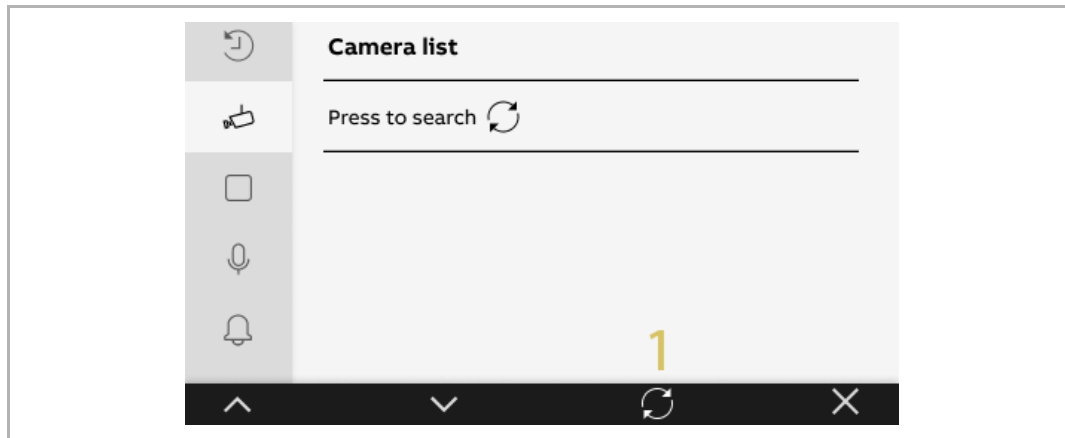

### 10.1.2 Creating a camera list

Please follow the steps below:

- [1] On the camera list, press “A screenshot of a mobile application interface titled "Camera list". The interface features a vertical sidebar on the left with five icons: a refresh icon (top), a camera icon, a square icon, a microphone icon, and a bell icon. The main content area has a header "Camera list" followed by a horizontal line and the text "Press to search" with a refresh icon. Below this is another horizontal line and a large, faint yellow number "1" centered in the lower half of the screen. At the bottom, there is a black navigation bar with four icons: a back arrow, a down arrow, a refresh icon, and a close 'X' icon.

### 10.1.3 Renaming the camera

Please follow the steps below:

[1] On the “Camera list” screen, select the designated camera.

[2] Press “ ✓ ”.

[3] Select “ ✎ ”.

[4] Press “ ✓ ”.

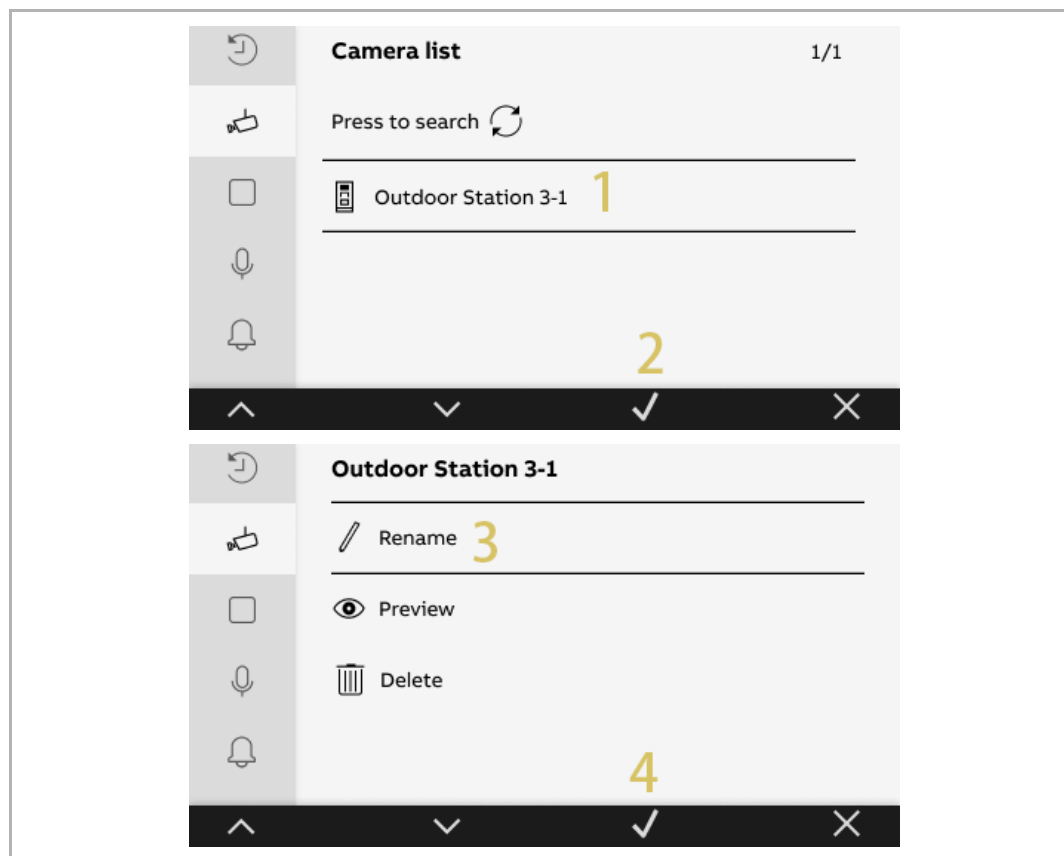

- [5] Select a camera name.
- [6] Press “ ✓ ”.
- [7] The camera name is displayed. It will be named with an incremented number (e.g. “Main door camera 1”.)

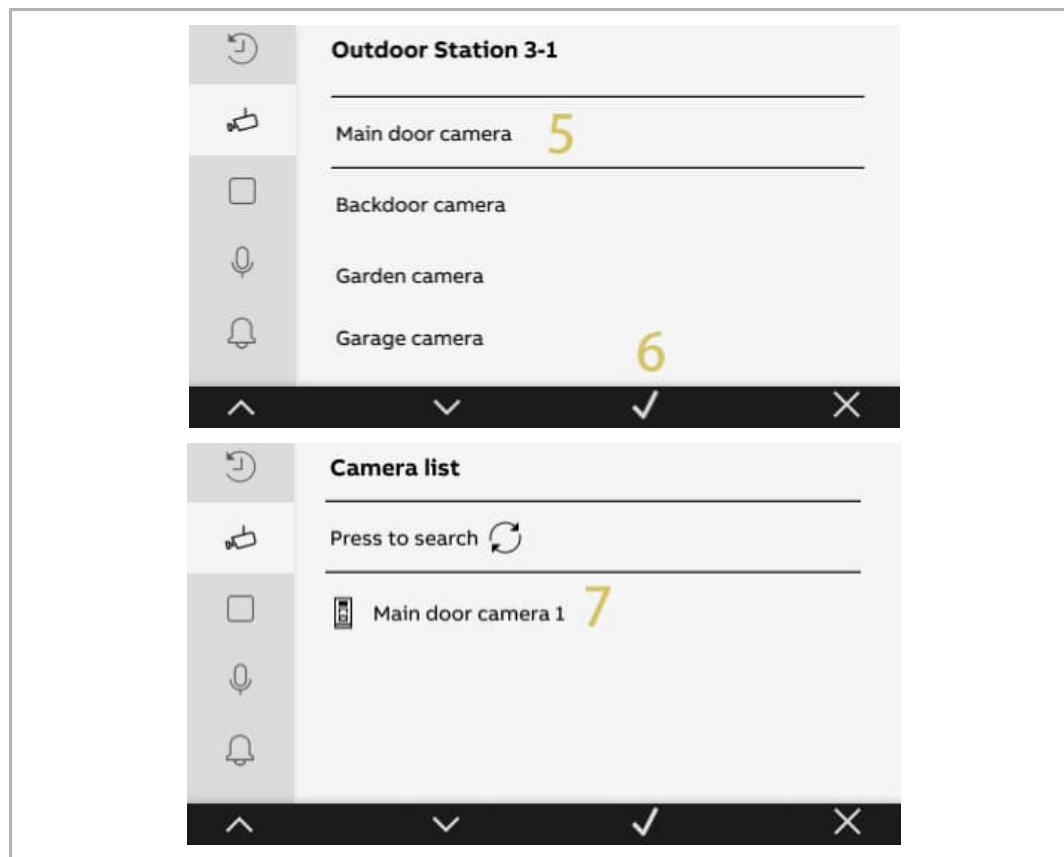



### 10.1.4 Previewing the camera

Please follow the steps below:

- [1] On the “Camera list” screen, select the designated camera.
- [2] Press “ ✓ ”.
- [3] Select “ 👁 Preview”.
- [4] Press “ ✓ ”.
- [5] The image from the camera will be displayed for 15 seconds. Press “ □ ” to terminate the preview.

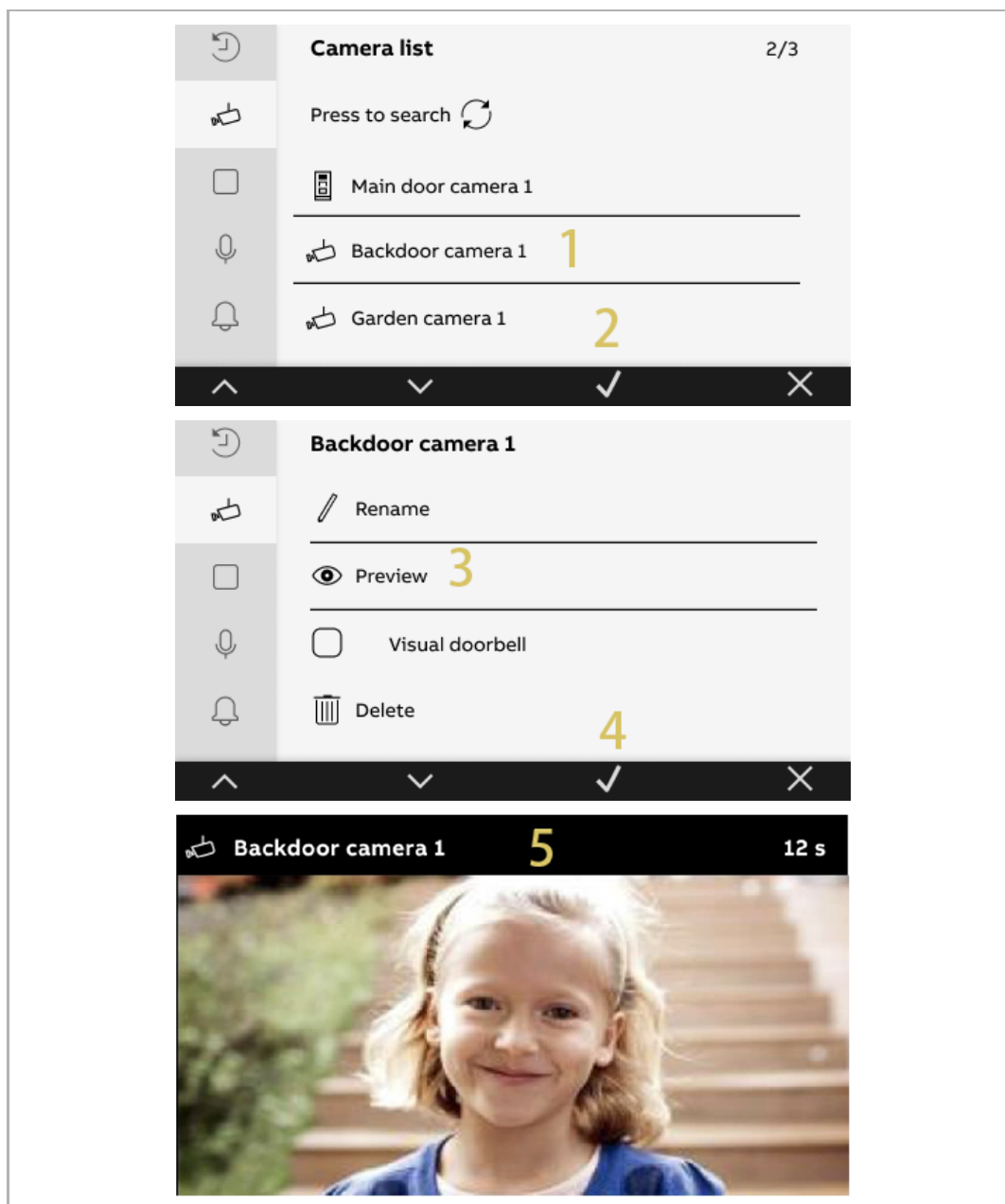

**Warning message**

A warning message will be displayed on the screen when the designated Outdoor Station is busy.

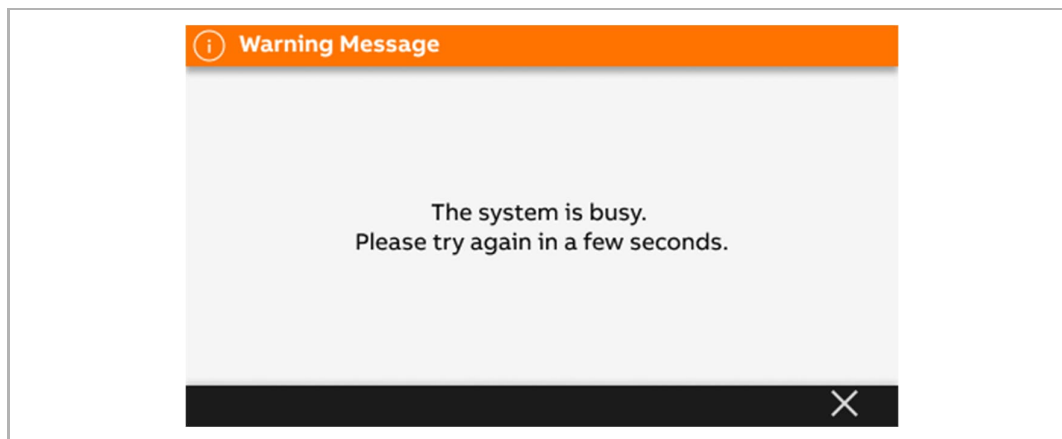
**Error message**

An error message will be displayed on the screen if the designated Outdoor Station is not detected by the system.

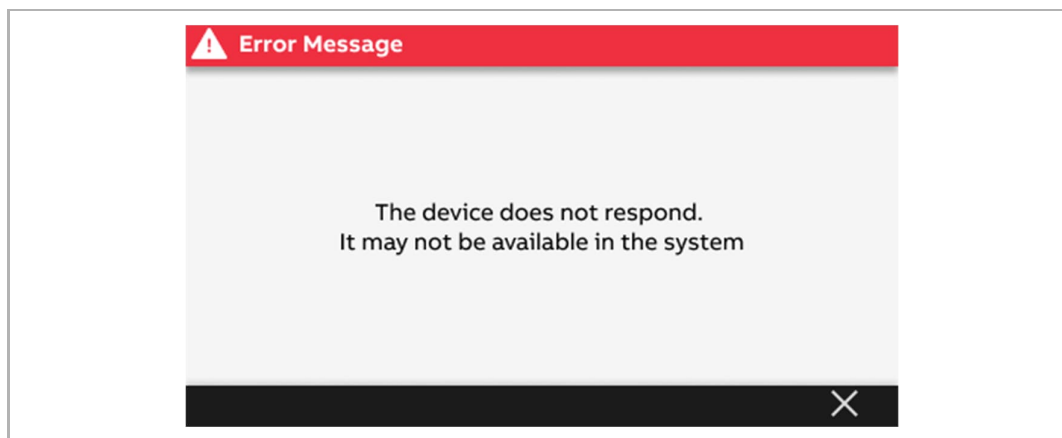

### 10.1.5 Visual doorbell setting

If a camera is set to “Visual doorbell”, when the doorbell is pressed, the image on this camera will be displayed on the Indoor Station.





#### Note

The “Visual doorbell” function can only be set when a camera is connected to the camera interface and this camera interface has been associated with the Indoor Station (mode = 4). Please see the camera interface product manual for more details.

Please follow the steps below:

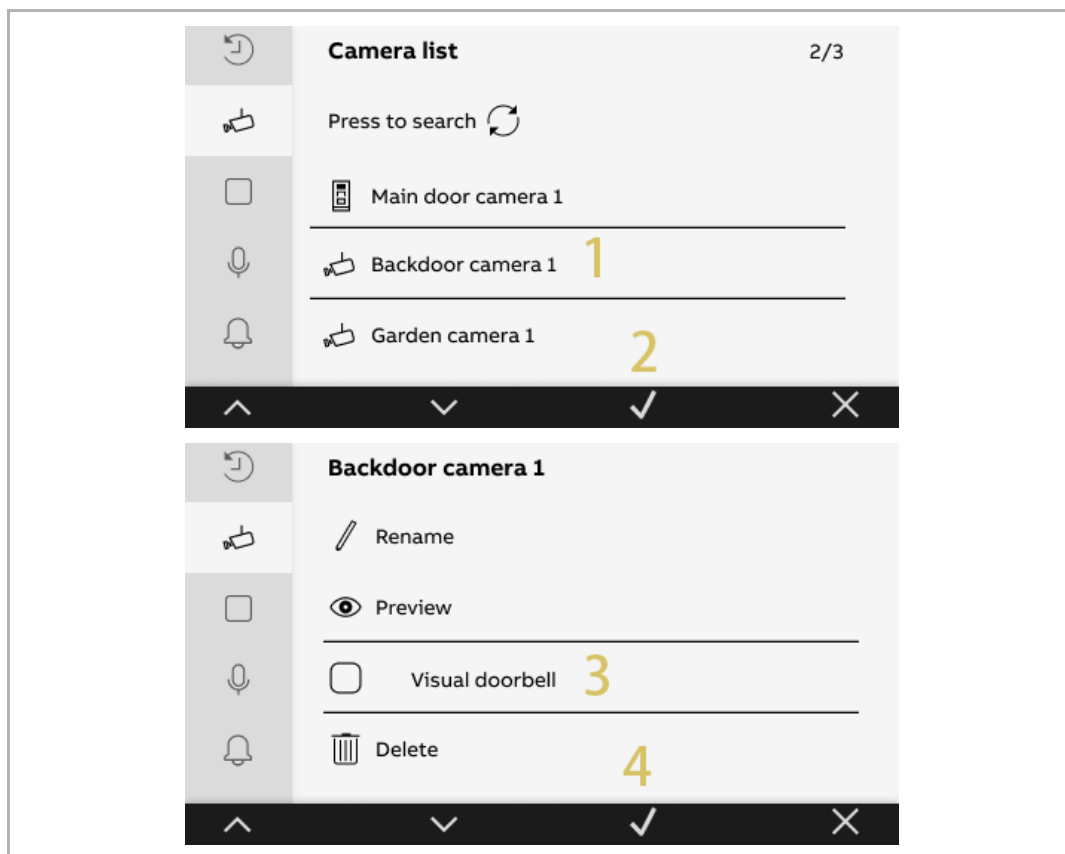
- [1] On the “Camera list” screen, select the designated camera.
- [2] Press “ ✓ ”.
- [3] Select “  ”.
- [4] Press “ ✓ ”.



[5] “” will be displayed on the screen if successful.

[6] Press “”.

[7] “” will be displayed on the screen to indicate the “Visual doorbell” status.



**Note**

Only one camera can be set to “Visual doorbell”.

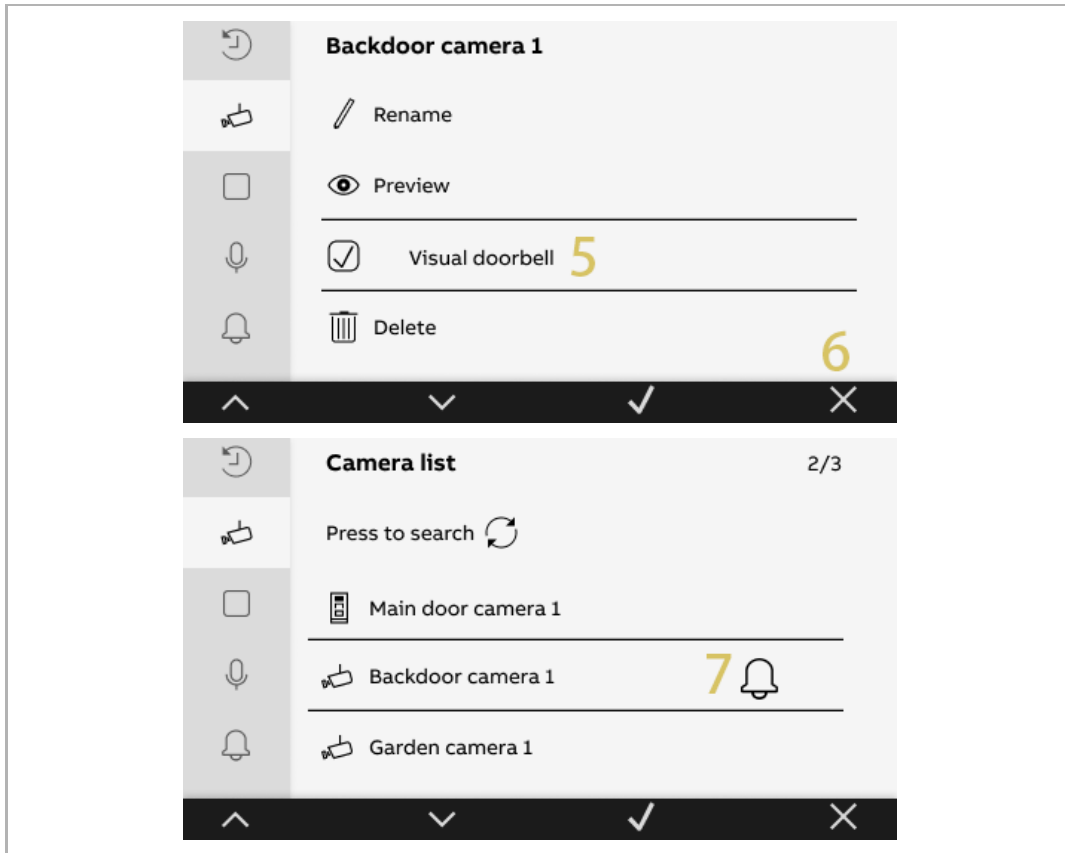

### 10.1.6 Removing the camera

Please follow the steps below:

[1] On the “Camera list” screen, select the designated camera.

[2] Press “ ✓ ”.

[3] Select “ 🗑 ”.

[4] Press “ ✓ ”.

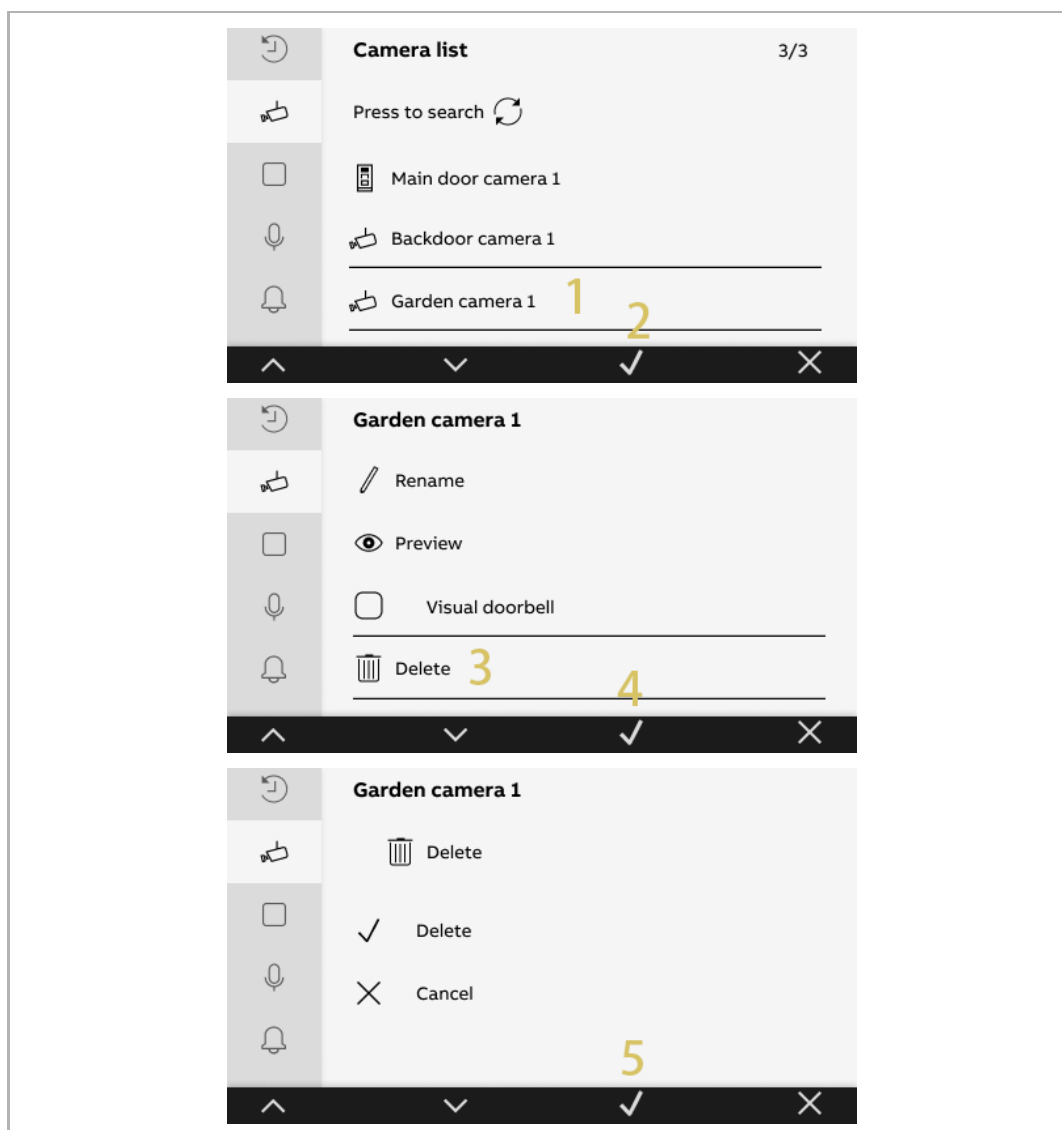

[5] Press “ ✓ ” again.



## 10.2 Program button settings

### 10.2.1 Accessing the "Program button" screen

Please follow the steps below:

- [1] In standby status, press “”.
- [2] Select “” on the side menu to access the corresponding screen.
- [3] Select “”.

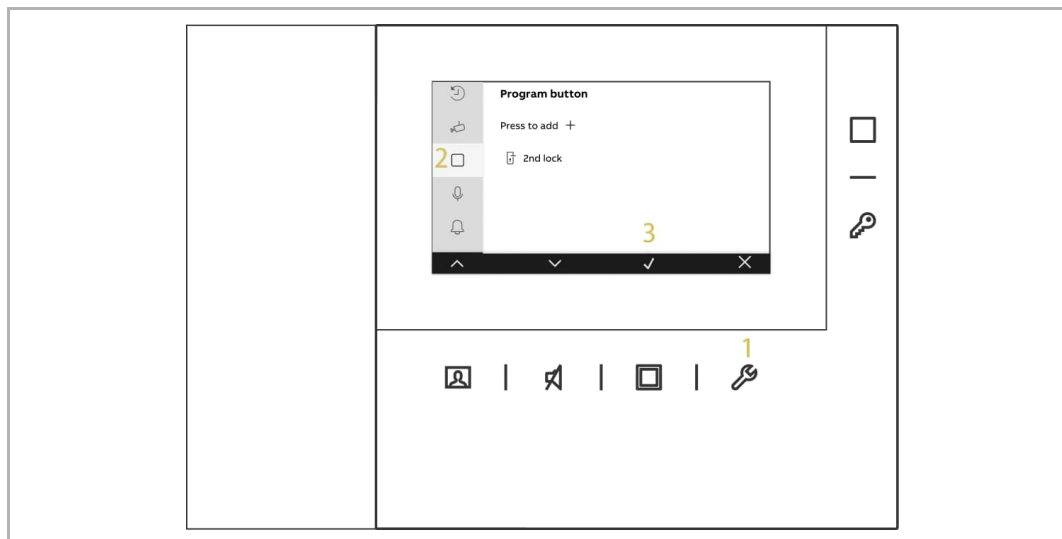

## 10.2.2 Adding a program function

Please follow the steps below:

- [1] On the “Program button” screen, press “ + ”.
- [2] Select a function; it can be set to “2nd lock”, “Light”, “Door” or “Actuator”.
- [3] Press “ ✓ ”.

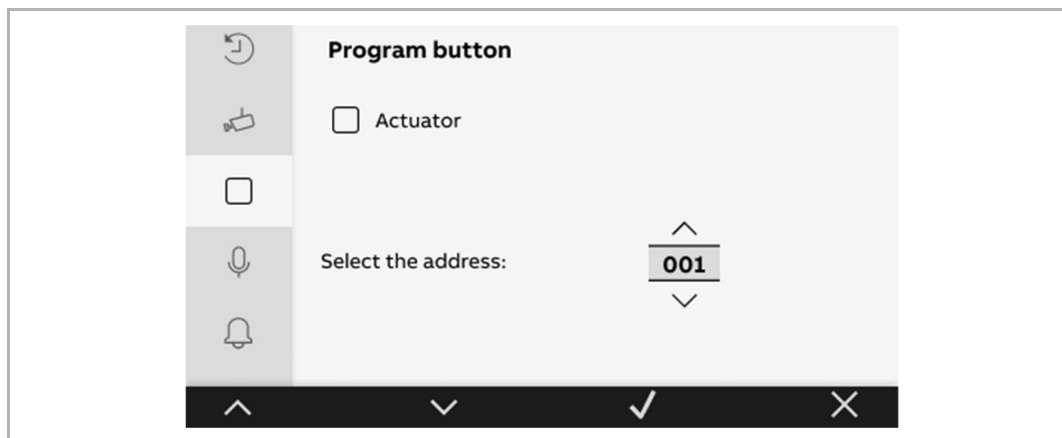

If the function is set to “Light”, “Door” or “Actuator”, you need to select the address.

**Note**

A maximum of 3 program functions can be set.



### 10.2.3 Removing the program function

Please follow the steps below:

[1] On the “Program button” screen, select the designated program button.

[2] Press “ ✓ ”.

[3] Select “  ”.

[4] Press “ ✓ ”.

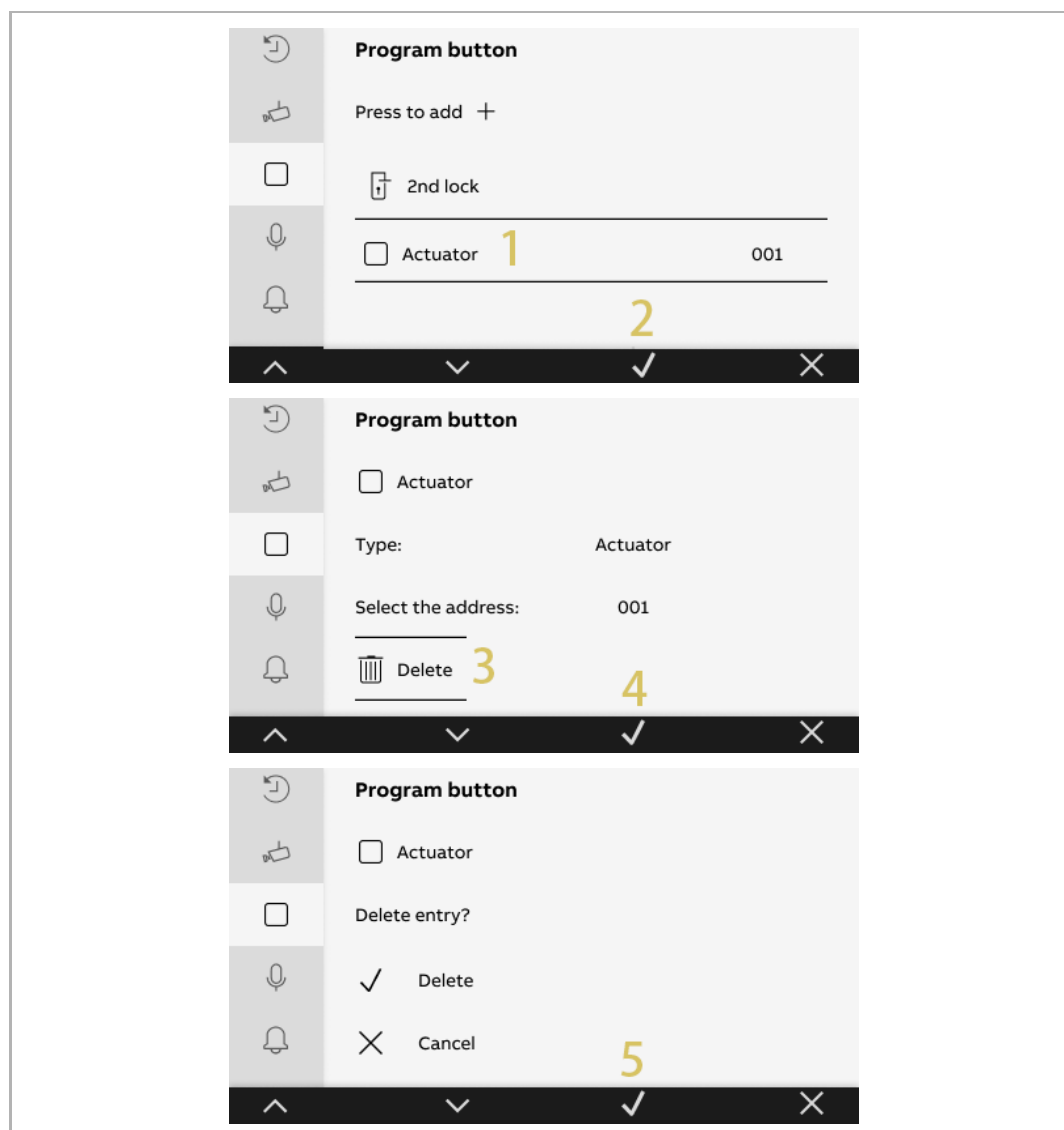

[5] Press “ ✓ ” again.



### 10.3 Intercom settings

#### 10.3.1 Accessing the "Intercom list" screen

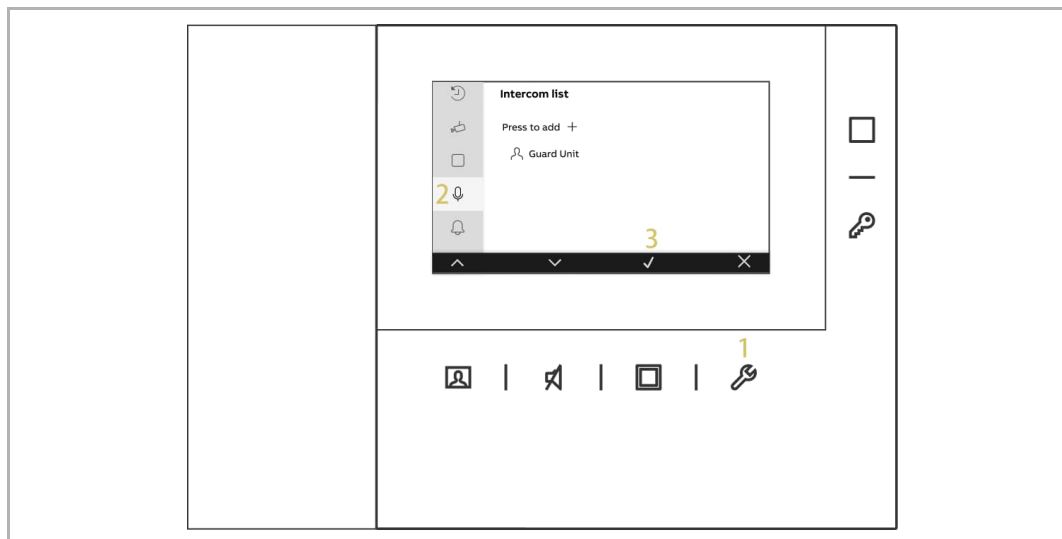

Please follow the steps below:

- [1] In standby status, press “”.
- [2] Select “” on the side menu to access the corresponding screen.
- [3] Select “”.



### 10.3.2 Adding an intercom

Please follow the steps below:

- [1] On the “Intercom list” screen, press “ + ”.
- [2] Select the intercom type. It can be set to “Intercom internal”, “Intercom external” or “Guard Unit”.
  -  = Intercom internal
  -  = Intercom external
- [3] Press “ ✓ ”.

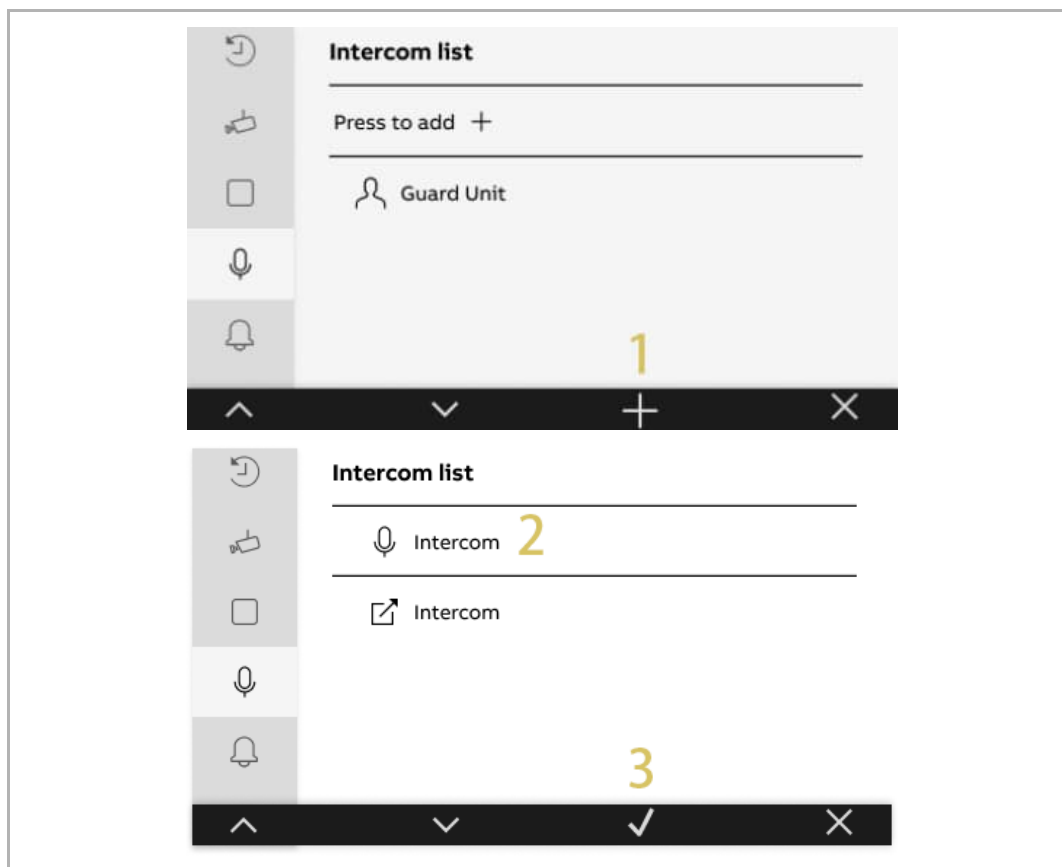

[4] If “” is selected, you need to set the address.

[5] Press “”.

If the intercom type is set to “Intercom internal”, you can skip steps 4 - 5.

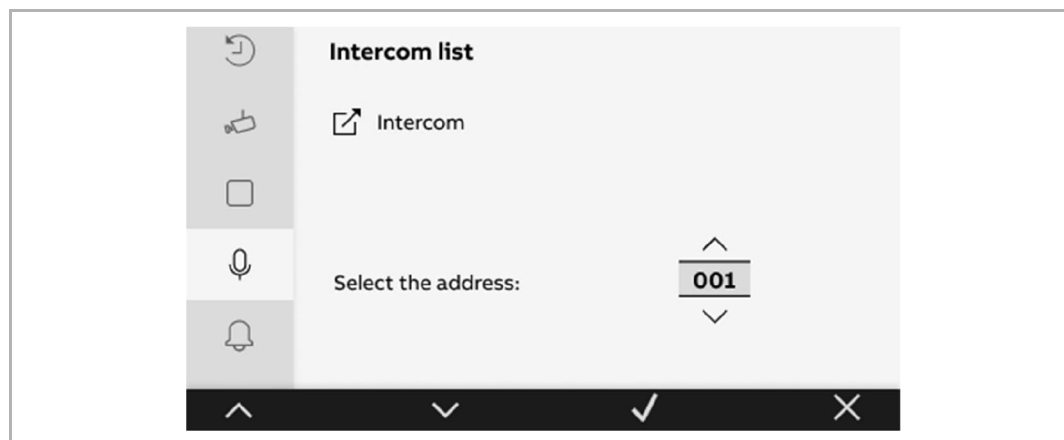
**Note**

A maximum of 3 intercoms can be set.

### 10.3.3 Removing the intercom

Please follow the steps below:

[1] On the “Intercom list” screen, press the designated intercom.

[2] Press “ ✓ ”.

[3] Select “ 🗑 ”.

[4] Press “ ✓ ”.

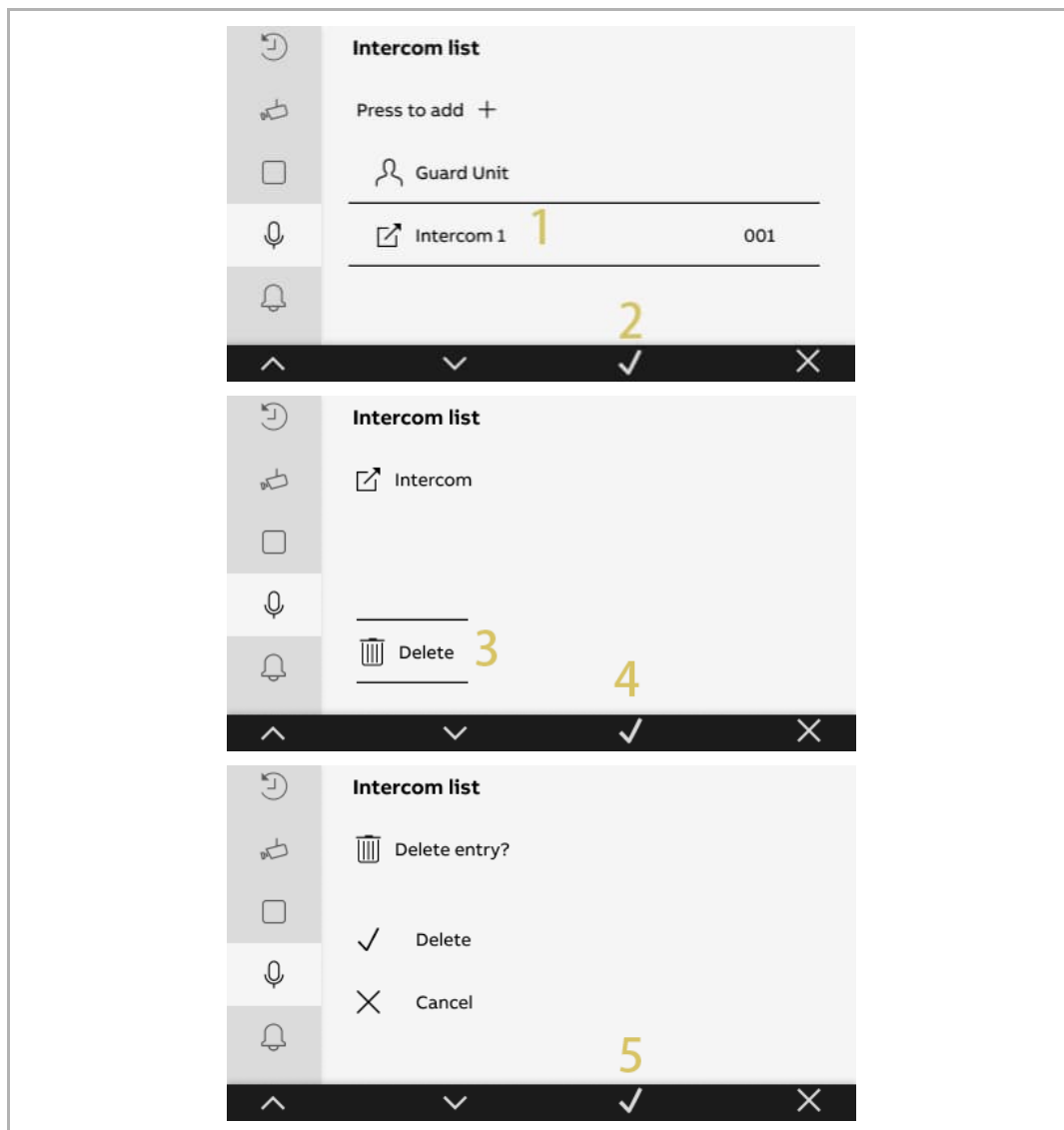

[5] Press “ ✓ ”. again.



## 10.4 Audio settings

### 10.4.1 Accessing the "Audio settings" screen

Please follow the steps below:

- [1] In standby status, press “”.
- [2] Select “” on the side menu.
- [3] Press “” to access the corresponding screen.

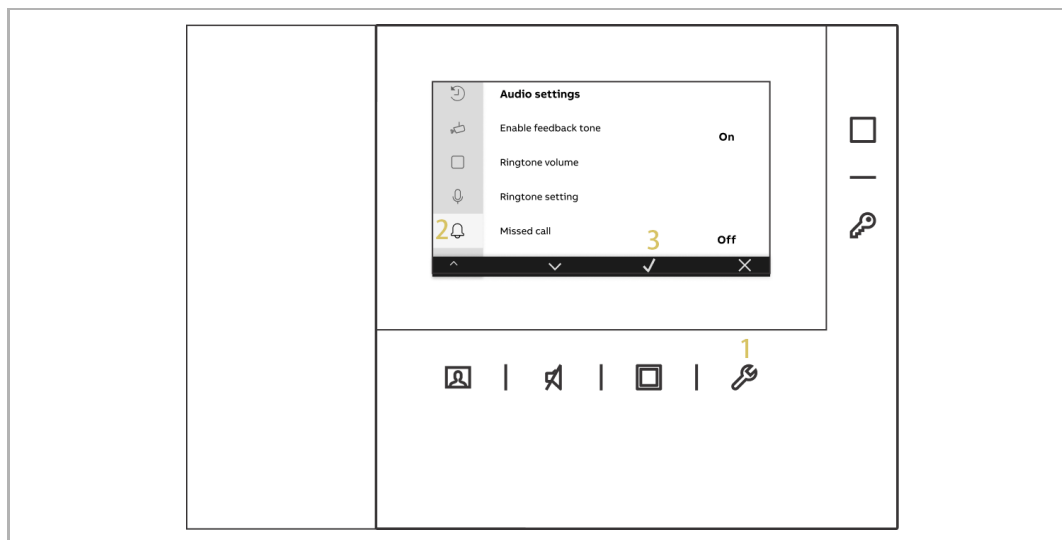

### 10.4.2 Setting the feedback tone

Please follow the steps below:

[1] On the “Audio settings” screen, select “Enable feedback tone”.

[2] Press “ ^ ” or “ v ” to enable/disable the function.

[3] Press “ ✓ ”.

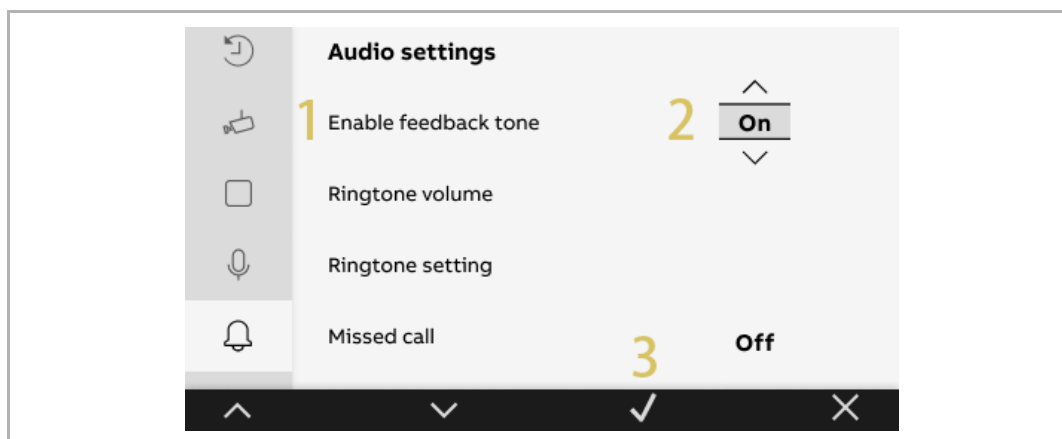

### 10.4.3 Setting the ringtone volume

Please follow the steps below:

[1] On the “Audio settings” screen, select “Ringtone volume”.

[2] Press “ ✓ ”.

[3] Press “ < ” or “ > ” to adjust the volume.

[4] Press “ x ” to save and exit the setting.





#### 10.4.4 Setting the ringtone type

Please follow the steps below:

- [1] On the “Audio settings” screen, select “Ringtone setting”.
- [2] Press “ ✓ ”.
- [3] Select the designated device, it can be “Default Outdoor Station”, “Other Outdoor Station”, “Intercom”, or “Doorbell”.
- [4] Press “ ✓ ”.
- [5] Select the ringtone.
- [6] Press “ ✓ ”.

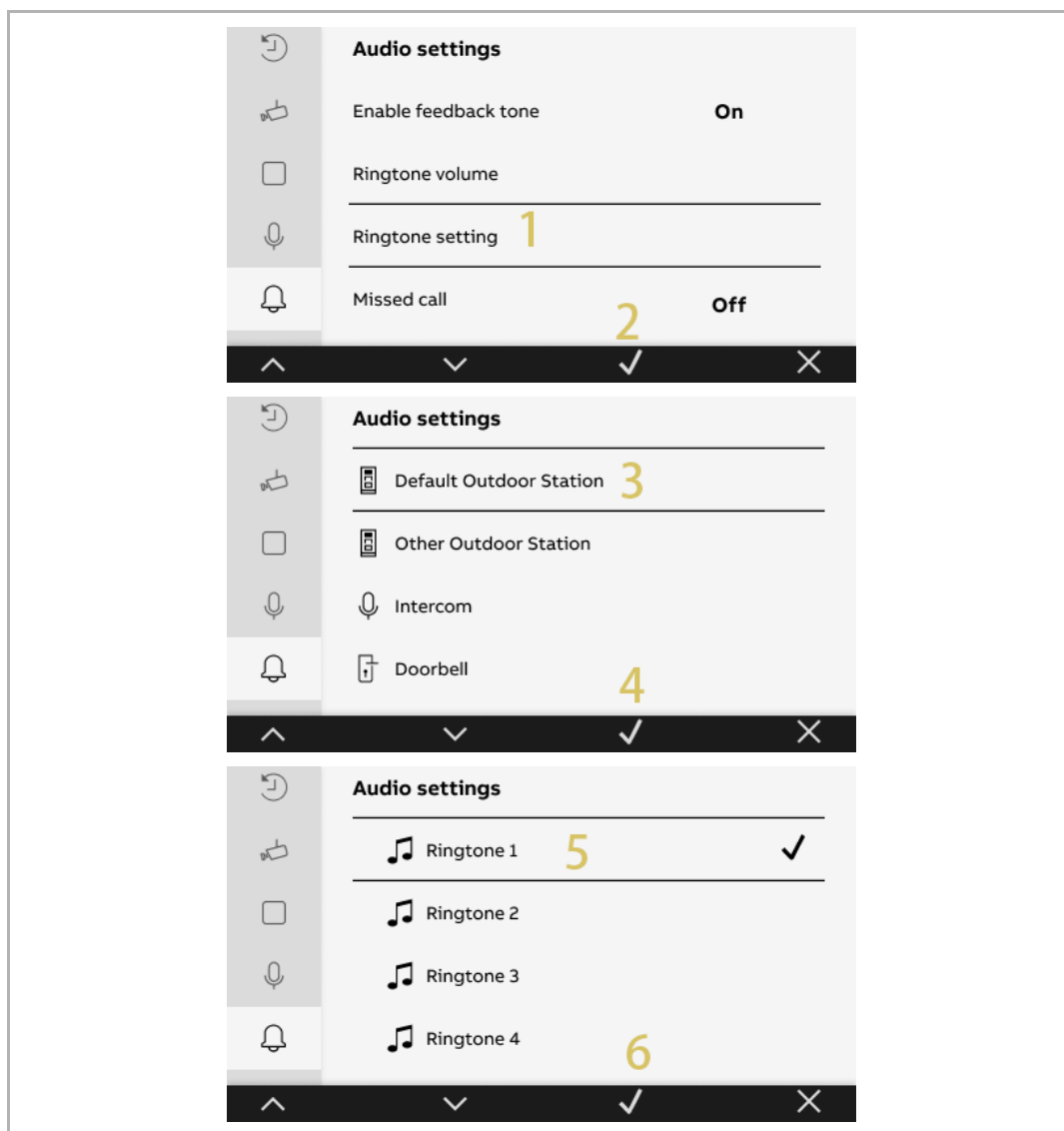

### 10.4.5 Setting the missed call

Please follow the steps below:

[1] On the “Audio settings” screen, select “Missed call”.

[2] Press “ ^ ” or “ v ” to enable/disable the function.

[3] Press “ ✓ ”.

If the “Missed call” function is enabled, “  ” will flash to indicate the missed calls.

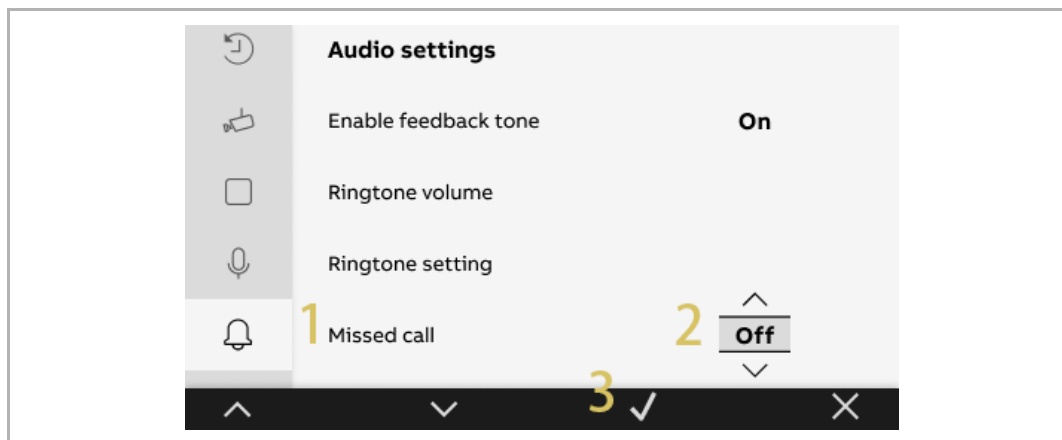



## 10.5 Unlock password



### Note

This function can only be set on the primary Indoor Station.

Please follow the steps below:

- [1] In standby status, press “”.
- [2] Select “” on the side menu.
- [3] Press “” to access the corresponding screen.

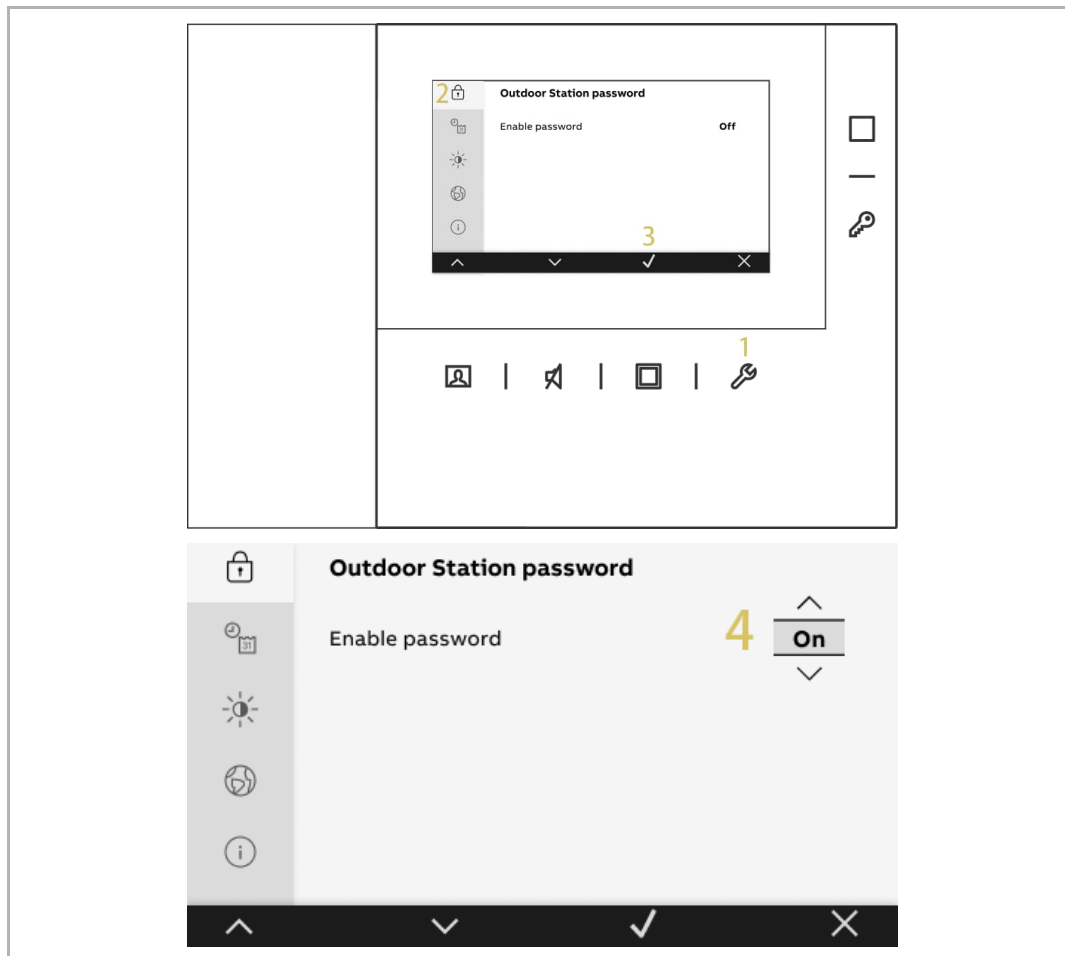

### Note

The feedback tone will be enabled automatically when carrying out this setting.

- [4] Select “Enter password” and press “ ^ ” or “ v ” to set the value for each digit one by one (3-8 digits).
- [5] “ ✓ ” will be displayed on the screen when the number of the digits reaches 3.
- [6] Select “Save”.
- [7] Press “ v ”.

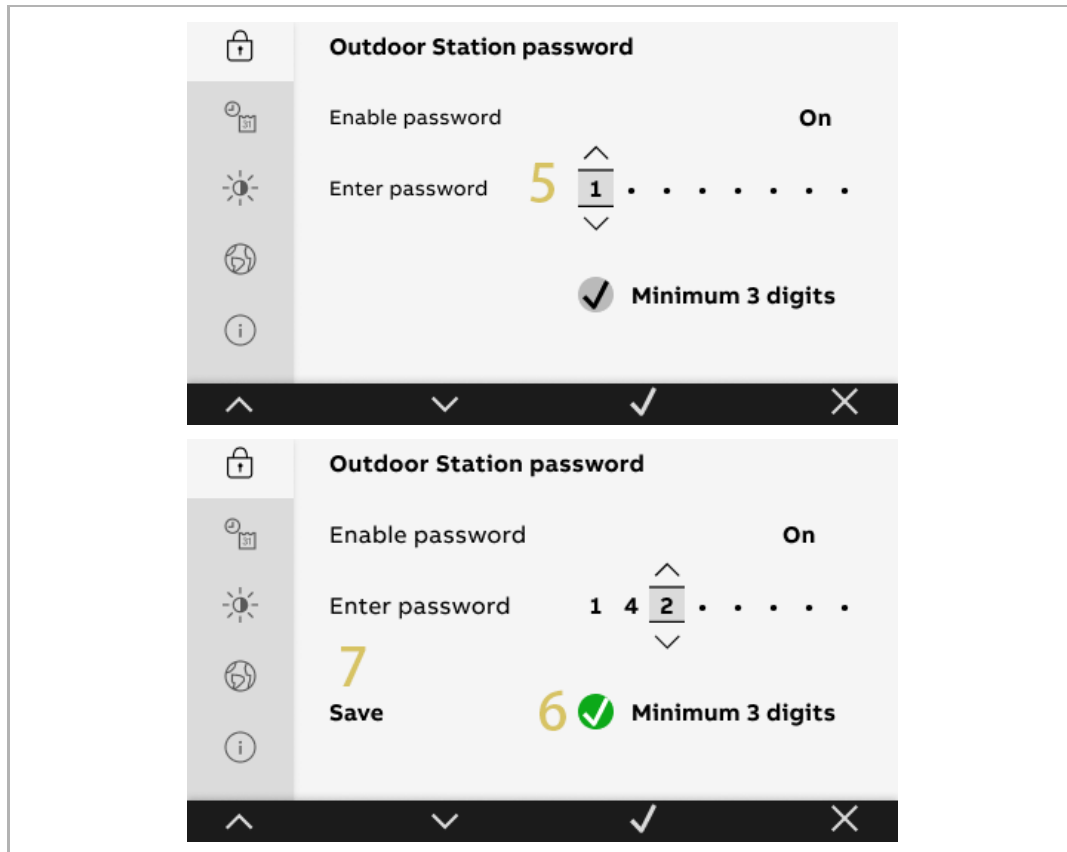

## 10.6 Date and time settings

Please follow the steps below:

- [1] In standby status, press “

The diagram illustrates the process of accessing the Date and time settings. It is divided into two main sections: the standby screen and the settings screen.

**Standby Screen:** Shows a side menu with icons for Date (2), Time (5), Summer time (6), and 24h (7). A wrench icon (1) is located at the bottom right of the screen.

**Date and time settings screen:** Shows the following settings:

  - Date: 2022 10 30 (4)
  - Time: 08 15 (5)
  - Summer time: Yes (6) / No (7)
  - 24h: 24h (7)

Numbered callouts (1-8) indicate the steps to navigate through the settings:

  - Wrench icon (1)
  - Date icon (2)
  - Checkmark icon (3)
  - Date selection (4)
  - Time selection (5)
  - Summer time selection (6)
  - 24h selection (7)
  - Checkmark icon (8)







### Note

It is recommended to correct your time once a year to ensure normal operation.

## 10.7 Display settings

Please follow the steps below:

- [1] In standby status, press “”.
- [2] On the “Settings” screen, select “” on the side menu to access the corresponding screen.
- [3] Press “” or “” to adjust the brightness.
- [4] Press “” to save and exit the setting.

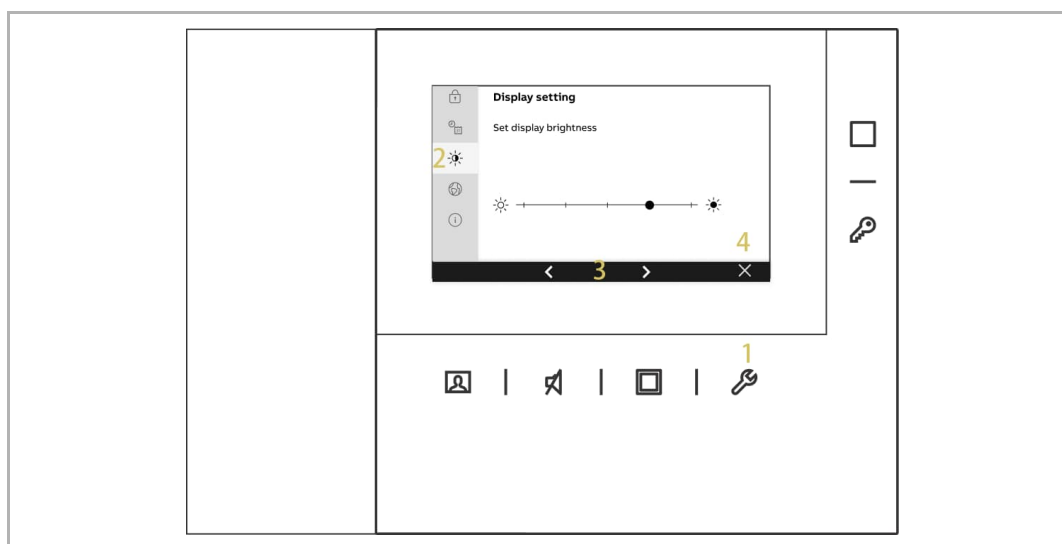

## 10.8 Language setting

- [1] In standby status, press “



The diagram illustrates the process of changing the language setting. It is divided into two main sections within a larger frame.

The top section shows a 'Settings' screen. On the left is a side menu with icons for various settings. A yellow '2' is next to the globe icon. The main area shows a 'Language' selection screen with a list of languages: English (checked), Italiano, Español, Français, Deutsch, Dansk, Čeština, and Português. A yellow '3' is at the bottom of this list. To the right of the settings area is a vertical bar with a key icon and a yellow '1' next to it.

The bottom section shows a close-up of the 'Language' selection screen. It has the title 'Language' and 'Select language:'. Below this is a list of languages: English (checked), Italiano, Español, Français, Deutsch, Dansk, Čeština, and Português. Red arrows indicate the selection path: from 'English' to 'Français' and then to 'Čeština'. At the bottom of this screen is a navigation bar with four icons: an up arrow, a down arrow, a checkmark, and an X.

## 10.9 About

Please follow the steps below:

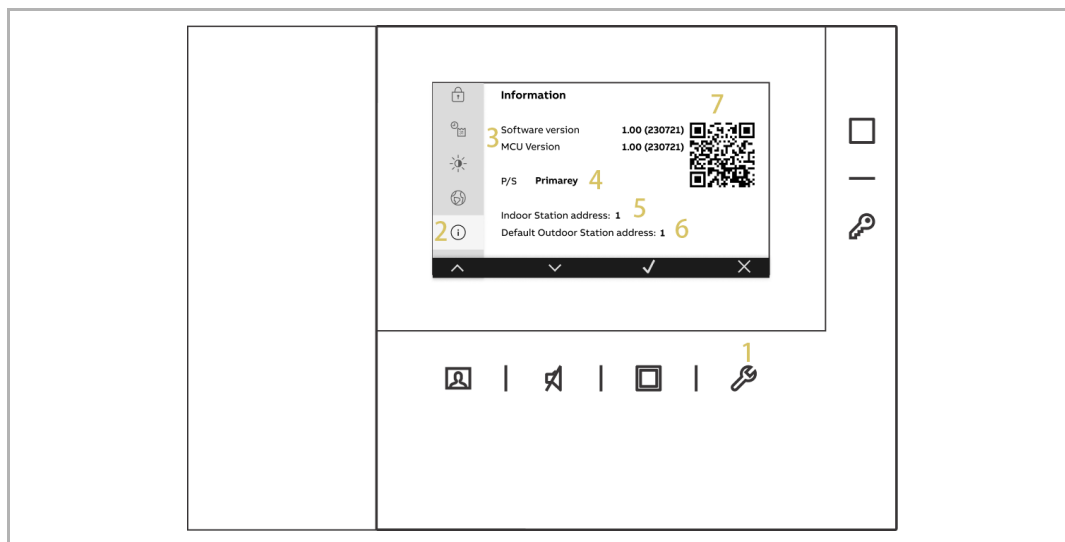

- [1] In standby status, press “”.
- [2] Select “” on the side menu to access the corresponding screen.
- [3] Display the software version.
- [4] Display the Indoor Station type: “Primary” or “Secondary”.
- [5] Display the Indoor Station address.
- [6] Display the default Outdoor Station address.
- [7] Scan the QR code to obtain the product manual.





### 10.10 Restoring to factory default

Please follow the steps below:

- [1] In standby status, press “”.
- [2] On the “Settings” screen, select “” on the side menu to access the corresponding screen.
- [3] Press “”.

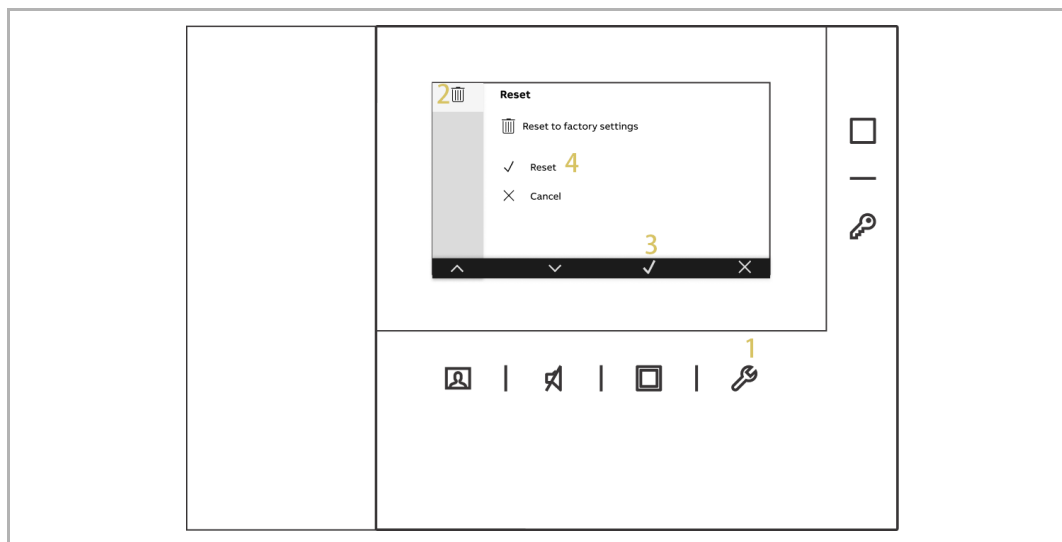

# 11 Cyber security

## 11.1 Disclaimer

M2247.-W products are designed to be connected and to communicate information and data via a 2-wire interface. It is the customer's sole responsibility to provide and continuously ensure a secure connection between the product and the customer's 2-wire system, and to establish and maintain appropriate measures to protect the M2247.-W product, 2-wire system and interfaces against any kind of security breaches, unauthorised access, interference, intrusion, leakage and/or theft of data or information. ABB Ltd and its affiliates are not liable for damages and/or losses related to such security breaches, unauthorised access, interference, intrusion, leakage and/or theft of data or information.

Although ABB provides functionality testing on the products and updates that we release, you should institute your own testing program for any product updates or other major system updates (to include but not limited to code changes, configuration file changes, third party software updates or patches, hardware change out, etc.) to ensure that the security measures that you have implemented have not been compromised and system functionality in your environment is as expected.

## 12 Notice

We reserve the right to at all times make technical changes as well as changes to the contents of this document without prior notice.

The detailed specifications agreed to at the time of ordering apply to all orders. ABB accepts no responsibility for possible errors or incompleteness in this document.

We reserve all rights to this document and the topics and illustrations contained therein. The document and its contents, or excerpts thereof, must not be reproduced, transmitted or reused by third parties without prior written consent by ABB.



---

#### Contact us

ABB Xiamen Smart Technology Co., Ltd.  
No. 881, FangShanXiEr Road, Xiang'An Industrial  
Area, Torch Hi-Tech Industrial Development  
Zone, Xiamen  
Tel: +86 592 295 9000  
Fax: +86 592 562 5072

[www.abb.com](http://www.abb.com)

Approvals and Compliances

#### Notice

We reserve the right to at all times make technical changes as well as changes to the contents of this document without prior notice. The detailed specifications agreed upon apply for orders. ABB accepts no responsibility for possible errors or incompleteness in this document.

We reserve all rights to this document and the topics and illustrations contained therein. The document and its contents, or extracts thereof, must not be reproduced, transmitted or reused by third parties without prior written consent by ABB.