

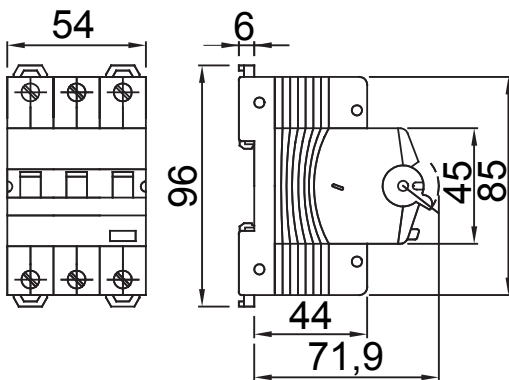

Omschrijving	RCCB MET OVERSTROOMBEVEILIGING
Code	MDC 60
Aant. polen	3P
Aant. modules	3
Nominale stroom	32 A
Nominale aardlekstroom	30 mA
Type	A
Curve	B
Nominale spanning (IEC/EN 61009-1, 61009-2-1)	400/415 V
Energiebeperkingsklasse	1

Standaard	IEC/EN 61009-1, IEC/EN 61009-2-1	Nominale frequentie (Hz)	50/60 Hz
Breekcapacitet IEC/EN 61009-1 400V (Icn)	6000 A	Breekcapaciteit IEC/EN 61009-1 (Ics)	1 x Icn
Breekcapacitet IEC/EN 60947-2 400V (Icu)	6 kA	Breekcapaciteit IEC/EN 60947-2 (Ics)	100% Icu
Isolatievoltage (Ui)	500 V	Immunitetsniveau (8/20 µs)	250 A
Nominale impuls schokbestendigheidsspanning (Uimp)	4 kV	Overspannings categorie	III
Elektrische duurbestendigheid	10.000	Mechanische duurbestendigheid	20.000
Sectie rigide kabel	<=1x35 - <=2x16 - <=1x16+2x10 mm²	Sectie flexibele kabel	<=1x35 - <=2x16 - <=1x16+2x10 mm²
Dubbele verbinding	JA (alleen stroomafwaarts)	Nominale aandraaikoppel	2 Nm
Bedrijfstemperatuur	-25 +60° C (derating van In met T>30° C)	Opslagtemperatuur	-40 +70 °C
Comptabiliteit aanvullingen	Ja	Montage positie	Elke

DIMENSIONAL



WIRING DIAGRAM

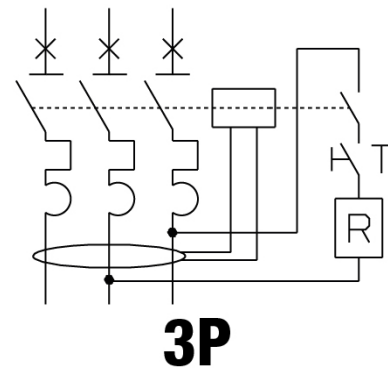

STANDARDS/APPROVALS

