

# Productinformatieblad

Specificaties

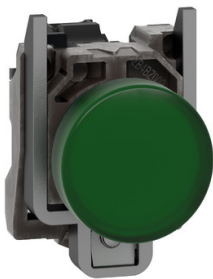

## Signaallamp, Rond, LED, Ø22mm, 24V, IP65, Groen

XB4BVB3

**Belangrijk bericht:** A change in appearance may be noted on the product but does not affect its use in terms of function and safety. This makes it compatible with our Universal LED blocks  
EAN Code: 3389110891928

**Prijs: 18,10 EUR**

### Hoofd

|                                    |                     |
|------------------------------------|---------------------|
| range of product                   | Harmony XB4         |
| product of component type          | Controlelampje      |
| device short name                  | XB4                 |
| kraag materiaal                    | Verchroomd metaal   |
| materiaal bevestigingskraag        | Zamak               |
| bevestigingsdiameter               | 22,5 mm             |
| koptype                            | Standaard           |
| verkoop per ondeelbare hoeveelheid | 1                   |
| vorm van kop signaleringseenheid   | Rond                |
| kap/operator of lenskleur          | Groen               |
| extra informatie operator          | Met gewone lens     |
| lichtbron                          | Universele LED      |
| lamp fitting                       | Integrale LED       |
| kleur lichtbron                    | Groen               |
| Us nominale voedingsspanning       | 24 V AC/DC 50/60 Hz |

### Complementair

|                                 |   |
|---------------------------------|---|
| hoogte                          | 47 mm   |
| breedte                         | 30 mm   |
| diepte                          | 54 mm   |
| beschrijving klemmen ISO n°1    | (X1-X2)PL   |
| gewicht product                 | 0,08 kg   |
| weerstand hoge druk drukring    | 7000000 Pa om 55 °C, afstand: 0.1 m   |
| aansluitingen - aansluitklemmen | Schroefklem aansluitingen, <= 2 x 1,5 mm <sup>2</sup> met kabeluiteinde In overeenstemming met IEC 60947-1<br>Schroefklem aansluitingen, 1 x 0,22...2 x 2,5 mm <sup>2</sup> zonder kabeluiteinde In overeenstemming met IEC 60947-1 |
| Ui nom isolatiespanning         | 250 V (vervuilingsgraad) 3) In overeenstemming met IEC 60947-1  |
| Uimp nom. schokgolfspanning     | 4 kV In overeenstemming met IEC 60947-1   |
| type signalering                | Vast  |
| stroomverbruik                  | 18 mA   |

De weergegeven prijs is de adviesprijs in euro excl. BTW. Deze kan onderhevig zijn aan korting. Neem contact op met uw lokale distributeur of detailhandel voor de daadwerkelijke prijs

|                            |   |
|----------------------------|---|
| levensduur                 | 100000 h bij nominale spanning en 25 °C   |
| bestand tegen stroompieken | 1 kV In overeenstemming met IEC 61000-4-5 |
| product presentatie        | Compleet product                          |
| voedingsspanningsgrenzen   | 19,2...30 V DC<br>21,6...26,4 V AC        |

## Omgeving

|   |  |
|---|--|
| beschermende behandeling                      | TH   |
| ambient air temperature for storage           | -40...70 °C  |
| omgevingstemperatuur voor werking             | -40...70 °C  |
| beschermingsklasse tegen elektrische schokken | Klasse I In overeenstemming met IEC 60536  |
| IP beschermingsgraad                          | IP66 In overeenstemming met IEC 60529<br>IP67<br>IP69<br>IP69K   |
| Enclosure Type                                | UL type 4X/13  |
| IK-beschermingsgraad                          | IK06 In overeenstemming met IEC 50102  |
| standards                                     | IEC 60947-5-5<br>IEC 60947-5-4<br>IEC 60947-5-1<br>JIS C8201-5-1<br>UL 508<br>CSA C22.2 Nr 14<br>IEC 60947-1<br>JIS C8201-1  |
| product certifications                        | CSA<br>UL listed   |
| trilling bestendigheid                        | 5 gn (f= 12...500 Hz) In overeenstemming met IEC 60068-2-6   |
| schokbestendigheid                            | 30 gn (duur = 18 ms) voor halve sinusgolf versnelling In overeenstemming met IEC 60068-2-27<br>50 gn (duur = 11 ms) voor halve sinusgolf versnelling In overeenstemming met IEC 60068-2-27 |
| weerstand tegen snelle piekspanningen         | 2 kV In overeenstemming met IEC 61000-4-4  |
| weerstand tegen elektromagnetische velden     | 10 V/m In overeenstemming met IEC 61000-4-3  |
| weerstand tegen elektrostatische ontlading    | 6 kV op contact (op metalen onderdelen) In overeenstemming met IEC 61000-4-2<br>8 kV in open lucht (in isolerende onderdelen) In overeenstemming met IEC 61000-4-2                         |
| elektromagnetische emissie                    | Klasse B In overeenstemming met IEC 55011  |

## Verpakkingseenheid

|                                 |           |
|---------------------------------|-----------|
| Eenheidstype van verpakking 1   | PCE       |
| Aantal eenheden in verpakking 1 | 1         |
| verpakking 1 hoogte             | 3,500 cm  |
| verpakking 1 breedte            | 5,500 cm  |
| verpakking 1 lengte             | 8,500 cm  |
| verpakking_1_gewicht            | 79,500 g  |
| Eenheidstype van verpakking 2   | S03       |
| Aantal eenheden in verpakking 2 | 150       |
| verpakking 2 hoogte             | 30,000 cm |

|                                 |            |
|---------------------------------|------------|
| verpakking 2 breedte            | 30,000 cm  |
| verpakking 2 lengte             | 40,000 cm  |
| verpakking 2 gewicht            | 12,203 kg  |
| Eenheidstype van verpakking 3   | P06        |
| Aantal eenheden in verpakking 3 | 1200       |
| verpakking_3_hoogte             | 75,000 cm  |
| verpakking 3 breedte            | 60,000 cm  |
| verpakking 3 lengte             | 80,000 cm  |
| verpakking 3 gewicht            | 107,160 kg |

## contractuele waarborg

|                       |    |
|-----------------------|----|
| Garantie (in maanden) | 18 |
|-----------------------|----|

Schneider Electric wil tegen 2050 de Net Zero-status hebben bereikt via partnerschappen in de toeleveringsketen, materialen met een lagere impact en circulariteit via onze doorlopende campagne "Use Better, Use Longer, Use Again" om de levensduur van producten en de recycleerbaarheid te verlengen.

[Uitleg van Environmental Data >](#)

[Hoe evalueren we de duurzaamheid van producten? >](#)

### Milieuoetafdruk

|   |                |
|---|----------------|
| Totale levenscyclus ecologische voetafdruk              | 13 kg CO2 eq.  |
| Koolstofvoetafdruk van de fabricagefase [A1–A3]         | 0.6 kg CO2 eq. |
| Koolstofvoetafdruk van de distributiefase [A4]          | 0 kg CO2 eq.   |
| Koolstofvoetafdruk van de installatiefase [A5]          | 0 kg CO2 eq.   |
| Koolstofvoetafdruk van de gebruiksfase [B2, B3, B4, B6] | 13 kg CO2 eq.  |
| Koolstofvoetafdruk van de einde-levensfase [C1–C4]      | 0.2 kg CO2 eq. |

## Use Better

### Materialen en verpakking

|  |  |
|--|--|
| Gemiddeld percentage gerecycleerde kunststof | 36 %   |
| Gemiddeld percentage gerecycleerd metaal     | 17 %   |
| Pakket met gerecycleerd karton               | Ja   |
| Verpakkingen zonder kunststof                | Ja   |
| SCIP-nummer                                  | 3d14fd98-3859-4733-a5ee-a3016769973c   |
| RoHS-richtlijn van de EU                     | <a href="#">Conform door vrijstelling</a>  |
| REACH-verordening                            | <a href="#">Referentie bevat zorgwekkende stoffen (SVHC) boven drempelwaarde</a> |

## Use Longer

### Levensduurverlenging

|                        |                   |
|------------------------|-------------------|
| Reparatie              | Nee               |
| Productreparatie-index | <a href="#">A</a> |

## Use Again

### Herverpakken en herfabriceren

|  |   |
|--|---|
| Percentage mogelijke recycleerbaarheid | 1   |
| Circulair Profiel                      | <a href="#">Informatie over einde levensduur</a>  |
| Terugname                              | Ja  |
| WEEE-label                             |  Het product moet op markten van de Europese Unie worden afgevoerd volgens specifieke afvalinzamelingsregels en mag nooit in een gewone vuilnisbak terechtkomen. |

## Dimensions Drawings

## Dimensions

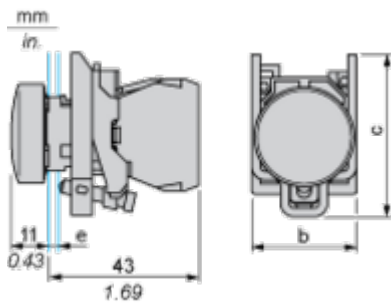

**e** : clamping thickness: 1 to 6 mm / 0.04 to 0.24 in.

**b** : 30 mm / 1.18 in.

**c** : 46.5 mm / 1.83 in.

Mounting and Clearance

Panel Cut-out for Pushbuttons, Switches and Pilot Lights (Finished Holes, Ready for Installation)

| Connection by Screw Clamp Terminals or Plug-in Connectors or on Printed Circuit Board   | Connection by Faston Connectors  |
|---|--|
|    |  |
| <p>(1) Diameter on finished panel or support<br/>                 (2) 40 mm min. / 1.57 in. min.<br/>                 (3) 30 mm min. / 1.18 in. min.<br/>                 (4) <math>\varnothing 22.5 \text{ mm} / 0.89 \text{ in. recommended } (\varnothing 22.3 \text{ mm }_0^{+0.4} / 0.88 \text{ in. }_0^{+0.016})</math><br/>                 (5) 45 mm min. / 1.78 in. min.<br/>                 (6) 32 mm min. / 1.26 in. min.</p> |  |

Technical Illustration

Dimensions

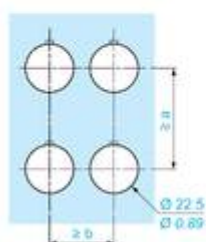
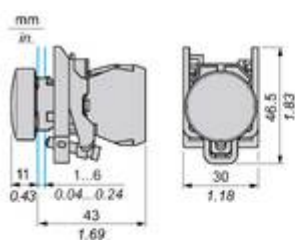

|           |           | a (mm) | a (in.) | b (mm) | b (in.) |
|-----------|-----------|--------|---------|--------|---------|
|           |           | 40     | 1.57    | 30     | 1.18    |
| ZBE.....  | ZBV.....  |        |         |        |         |
|           |           | 45     | 1.77    | 32     | 1.26    |
| ZBE.....3 | ZBV.....3 |        |         |        |         |
|           |           | 40     | 1.57    | 30     | 1.18    |
| ZBE.....4 | ZBV.....4 |        |         |        |         |
|           |           | 50     | 1.97    | 30     | 1.18    |
| ZBE.....5 | ZBV.....5 |        |         |        |         |
|           |           | 40     | 1.57    | 30     | 1.18    |
| ZBE.....9 | ZBV.....9 |        |         |        |         |
| ZBRT●     | ZBRV1     | 40     | 1.57    | 30     | 1.18    |

Offer Marketing Illustration





Product benefits / Features

---

The graphic features a green background with the title "Features" and subtitle "Harmony XB4/XB5 Illuminated functions". It contains four feature descriptions, each with an icon and a product image: 1. "NEW universal LED Block for all colors" with a square icon and a green button image. 2. "Simple stock management" with a person icon and a black button image. 3. "Improved installation time and easy selection" with a circular arrow icon and a yellow button image. 4. "Improved color intensity and brightness" with a sun icon and a red button image.

### Features

Harmony XB4/XB5 Illuminated functions

-  NEW universal LED Block for all colors
-  Simple stock management
-  Improved installation time and easy selection
-  Improved color intensity and brightness

Offer Marketing Illustration

Product benefits / Features

---

## Technical Benefits

### Harmony XB4



Offer Marketing Illustration

Product benefits / Features

---

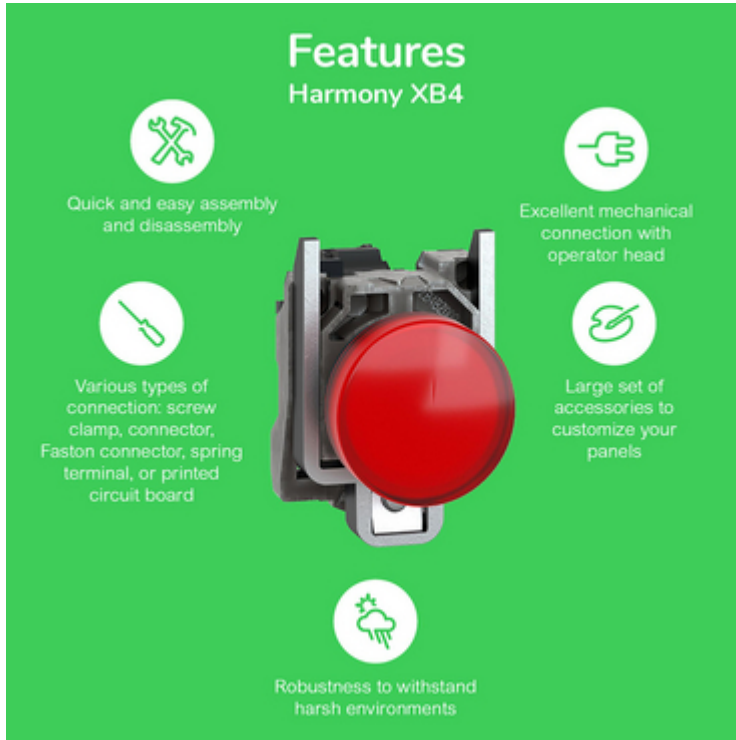

The infographic features a central image of a red Schneider XB4 terminal block. Surrounding it are five circular icons, each with a corresponding text description of a feature. The background is a solid green color.

### Features Harmony XB4





-  Quick and easy assembly and disassembly
-  Various types of connection: screw clamp, connector, Faston connector, spring terminal, or printed circuit board
-  Excellent mechanical connection with operator head
-  Large set of accessories to customize your panels
-  Robustness to withstand harsh environments

Image of product / Alternate images

Alternative

---

