

Ekip Dip LS/I
Ekip Dip LIG
Ekip Dip LSI
Ekip Dip LSI G
Ekip M Dip I <small>(solo per intr.ri tripolari) (only for 3-pole c.breakers)</small>
Ekip M Dip LIU <small>(solo per intr.ri tripolari) (only for 3-pole c.breakers)</small>
Ekip G Dip LS/I

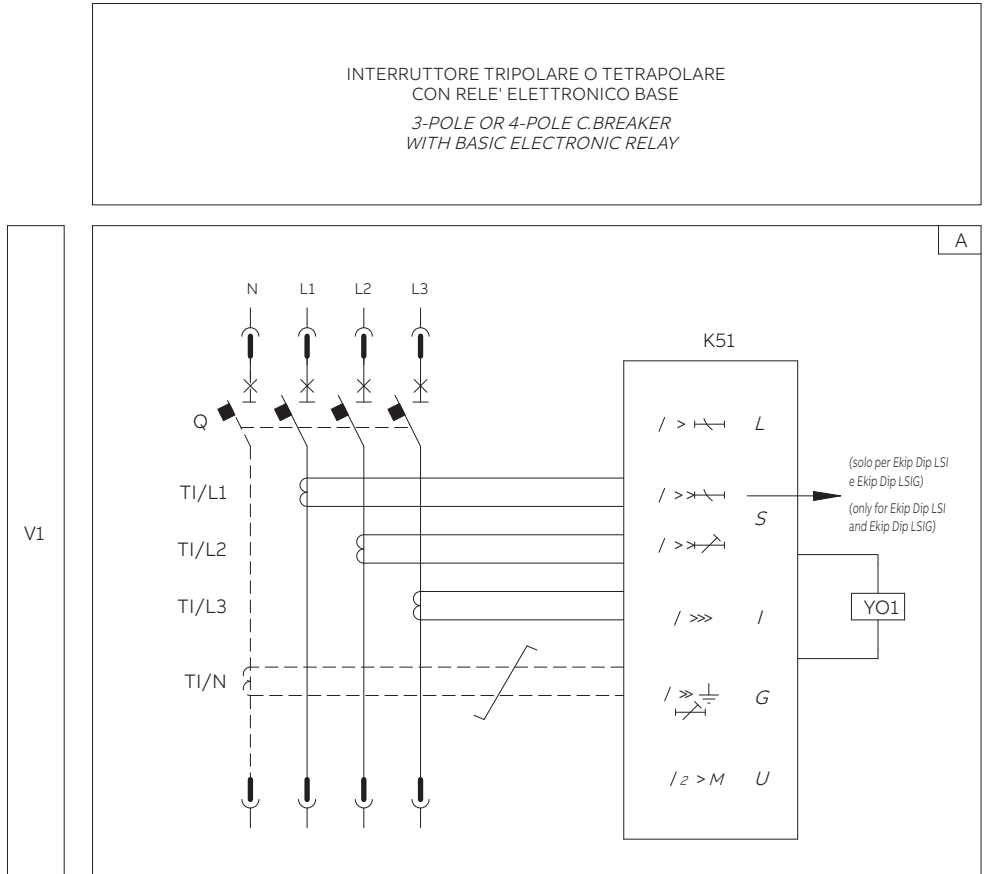

Ekip Touch LSI
Ekip Touch LSI G
Ekip Touch Measuring LSI
Ekip Touch Measuring LSI G
Ekip Hi-Touch LSI
Ekip Hi-Touch LSI G
Ekip M Touch LRIU <small>(solo per intr.ri tripolari) (only for 3-pole c.breakers)</small>
Ekip G Touch LSI G
Ekip G Hi-Touch LSI G

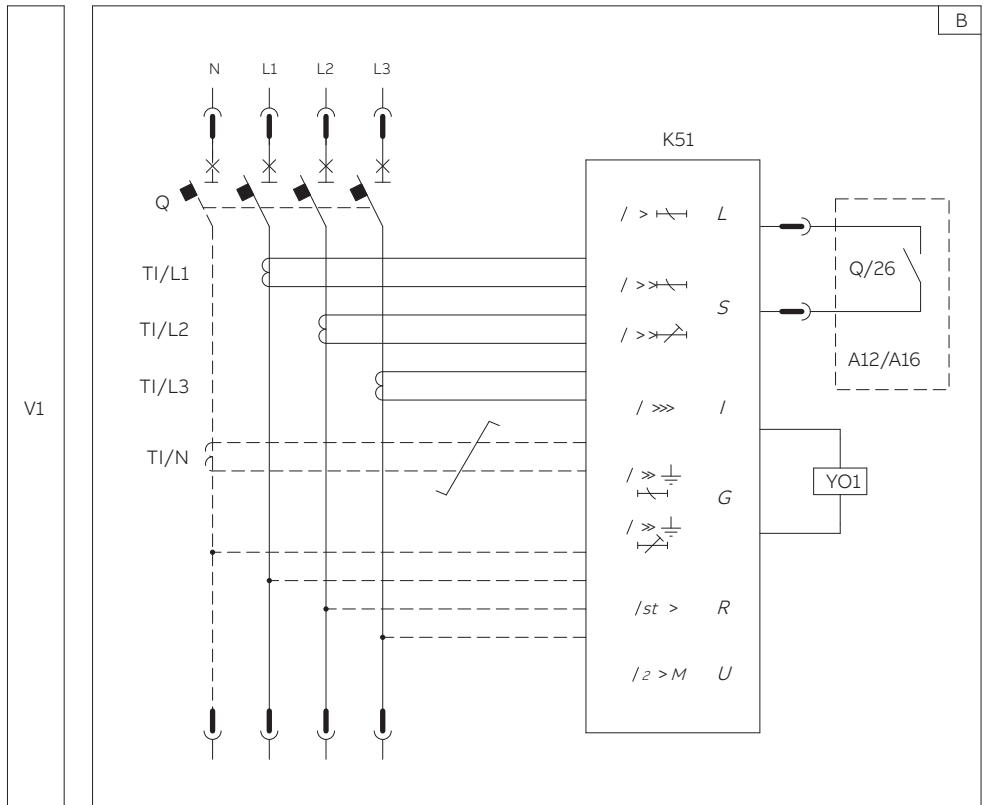
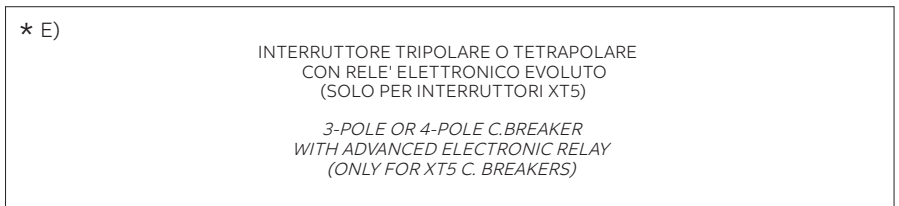

This document in .dwg format can be retrived directly here:

[1SDM000005A1DWG](#)

INTERRUTTORE DI MANOVRA-SEZIONATORE
 TRIPOLARE O TETRAPOLARE XT5D - XT6D
 3-POLE OR 4-POLE SWITCH-DISCONNECTOR
 XT5D - XT6D

V1

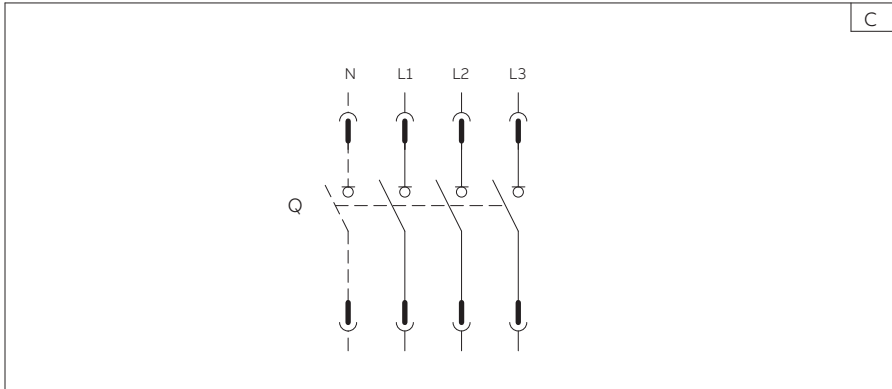

C

INTERRUTTORE TRIPOLARE O TETRAPOLARE
 CON RELE' TERMOMAGNETICO
 3-POLE OR 4-POLE C.BREAKER
 WITH THERMOMAGNETIC RELEASE

V1

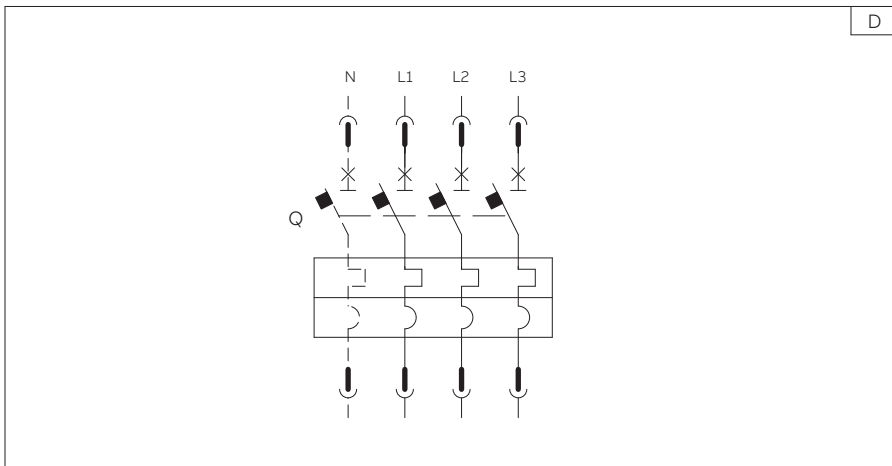

D

TMA
TMG

* AG)

* E)

INTERRUTTORE TRIPOLARE
 CON RELE' MAGNETICO
 3-POLE C.BREAKER
 WITH MAGNETIC RELEASE

V1

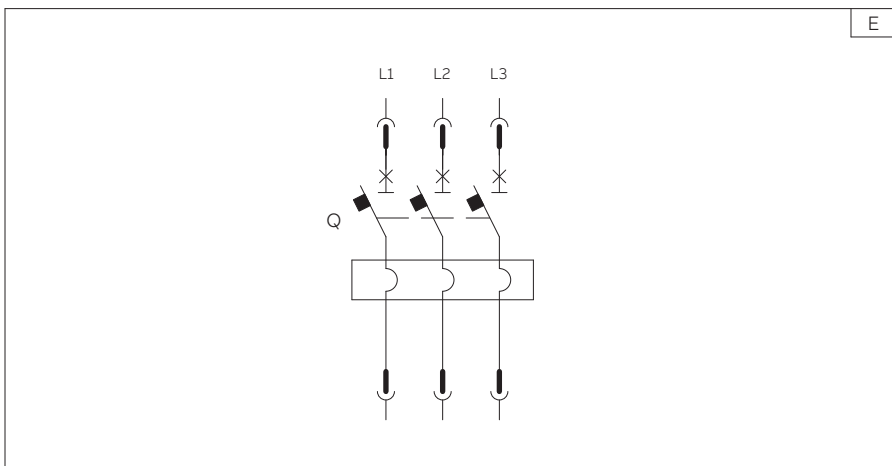

E

MF
MA

* E)

INTERRUTTORE TRIPOLARE O TETRAPOLARE
CON RELE' TERMOMAGNETICO E RELE' DIFFERENZIALE

3-POLE OR 4-POLE C.BREAKER
WITH THERMOMAGNETIC RELAY AND RESIDUAL CURRENT RELEASE

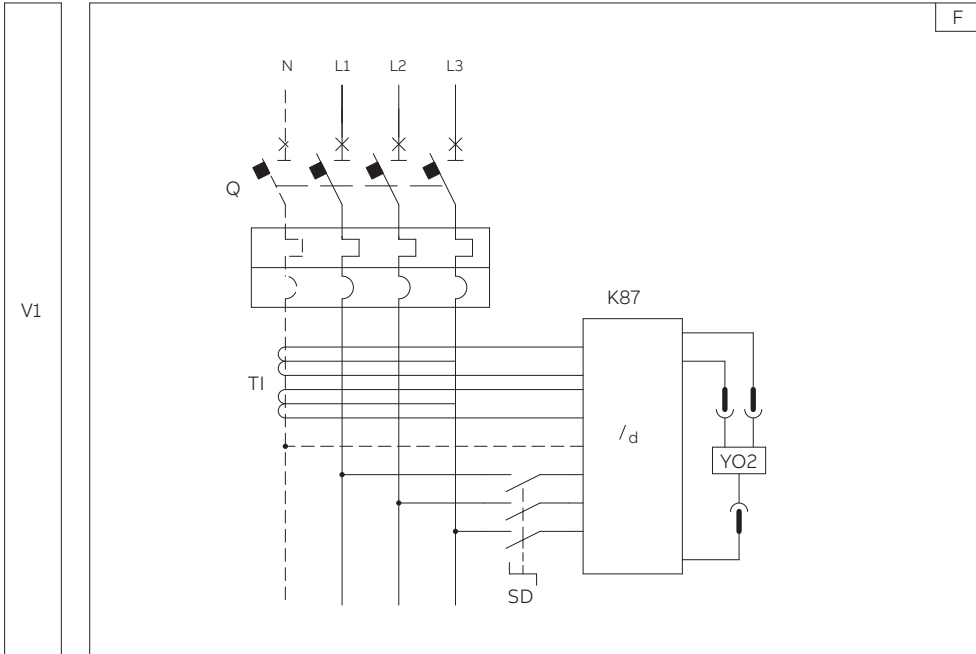

TM. + RC Sel XT5

(anche per intrin in esecuzione estraibile o rimovibile)
(also for plug-in or withdrawable version cbreakers)

* E)

INTERRUTTORE TETRAPOLARE
CON RELE' ELETTRONICO E RELE' DIFFERENZIALE

4-POLE C.BREAKER
WITH ELECTRONIC RELAY AND RESIDUAL CURRENT RELEASE

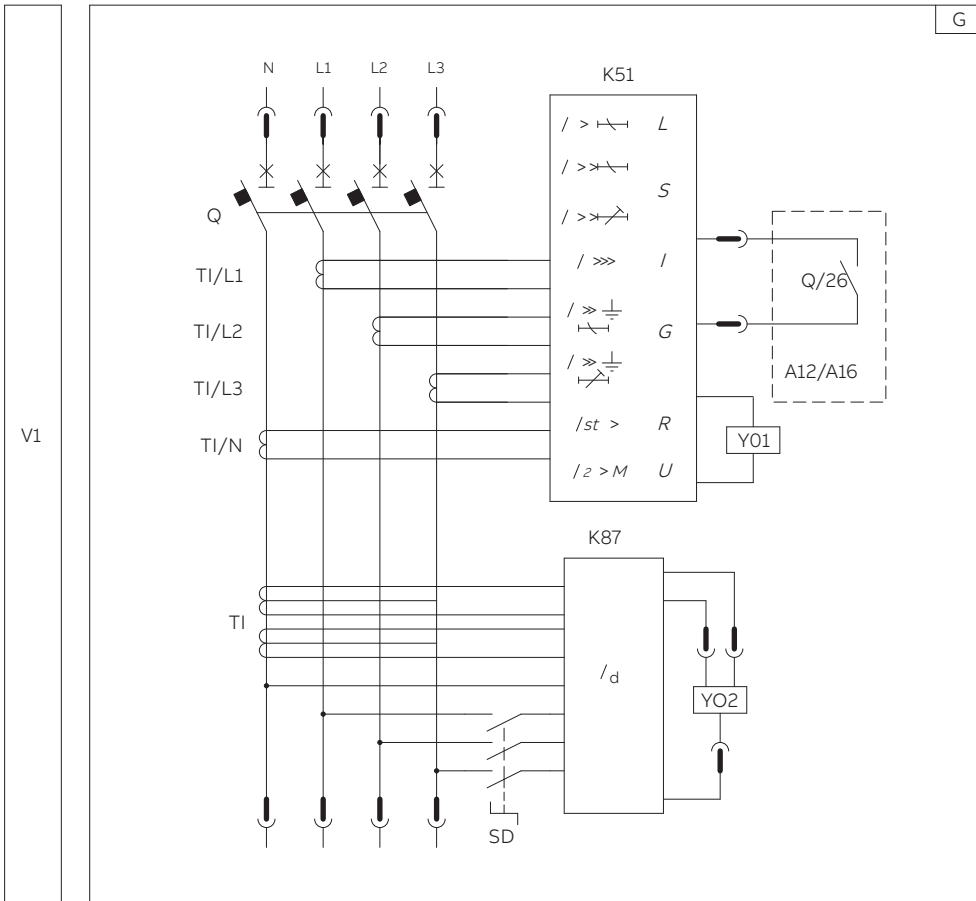

Ekip ... + RC Sel XT5

Ekip Dip LS/I

Ekip Dip LIG

Ekip Dip LSI

Ekip Dip LSIG

Ekip G Dip LS/I

Ekip Touch LSI

Ekip Touch LSIG

Ekip Touch Measuring LSI

Ekip Touch Measuring LSIG

Ekip Hi-Touch LSI

Ekip Hi-Touch LSIG

Ekip G Touch LSIG

Ekip G Hi-Touch LSIG

INTERRUTTORE TRIPOLARE IN ESECUZIONE FISSA CON RELE' ELETTRONICO BASE E CON
 TRASFORMATORE DI CORRENTE SU CONDUTTORE NEUTRO ESTERNO ALL'INTERRUTTORE
*FIXED VERSION 3-POLE C.BREAKER WITH BASIC ELECTRONIC RELAY AND WITH
 CURRENT TRANSFORMER ON NEUTRAL CONDUCTOR, EXTERNAL TO C.BREAKER*

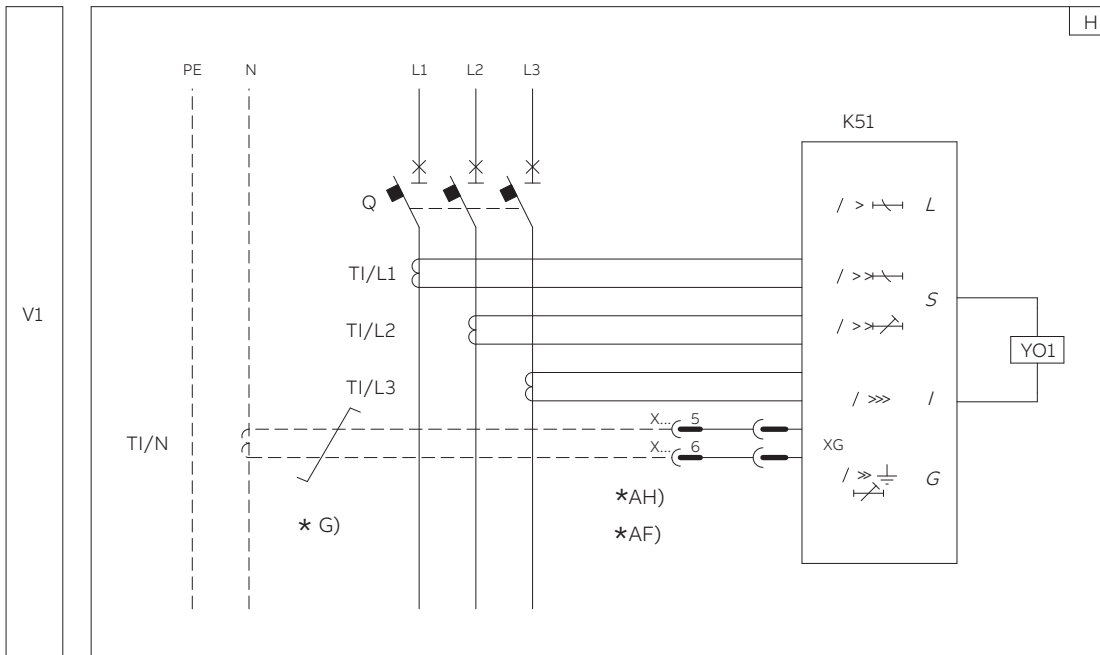

Ekip Dip LIG
Ekip Dip LSI
Ekip Dip LSIG

SCHEMA CONSIGLIATO PER INTERRUTTORE TRIPOLARE IN ESECUZIONE RIMOVIBILE O
 ESTRAIBILE CON RELE' ELETTRONICO BASE E CON
 TRASFORMATORE DI CORRENTE SU CONDUTTORE NEUTRO ESTERNO ALL'INTERRUTTORE

*ADVISABLE DIAGRAM FOR PLUG-IN OR WITHDRAWABLE VERSION 3-POLE
 C.BREAKER WITH BASIC ELECTRONIC RELAY AND WITH
 CURRENT TRANSFORMER ON NEUTRAL CONDUCTOR, EXTERNAL TO C.BREAKER*

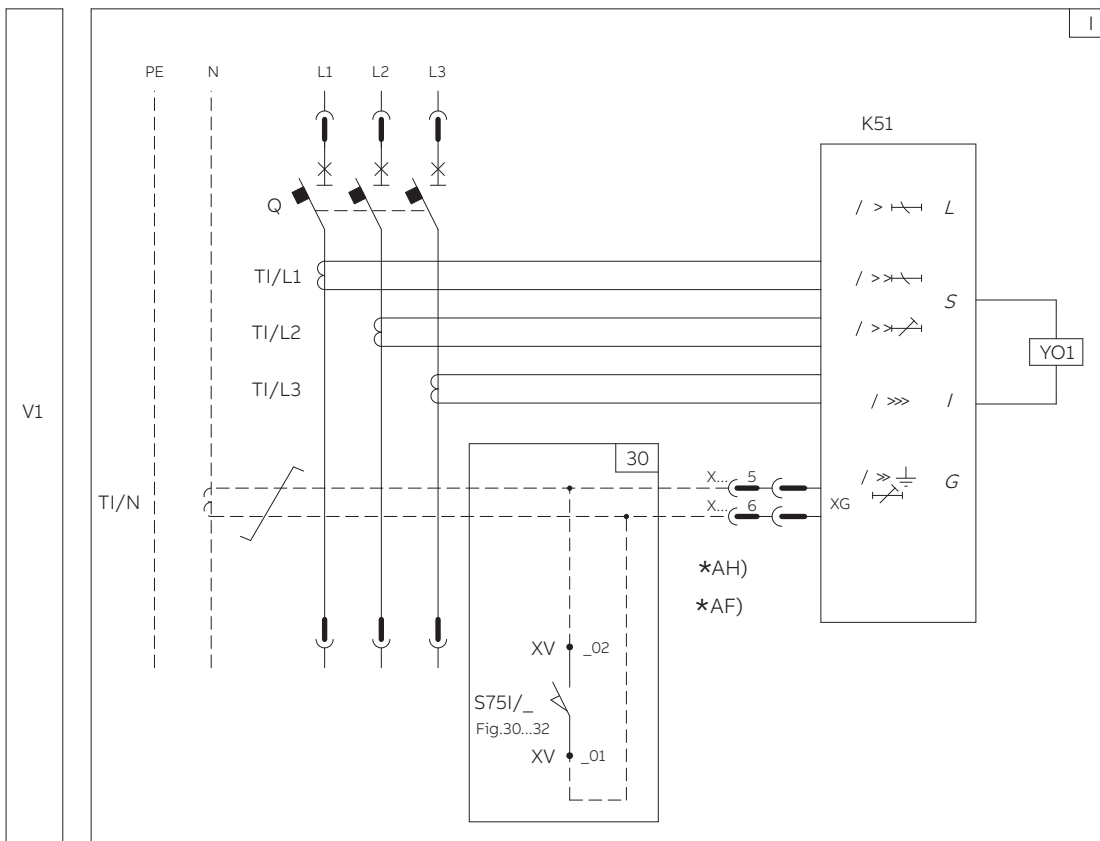

Ekip Dip LIG
Ekip Dip LSI
Ekip Dip LSIG

* E)

INTERRUTTORE TRIPOLARE XT5 IN ESECUZIONE FISSA E Ne ESTERNO CON RELE' ELETTRONICO EVOLUTO E PRESE DI TENSIONE SU FASI E Ne ESTERNO ALL'INTERRUTTORE (SOLO PER INTERRUTTORI XT5)
 FIXED VERSION 3-POLE XT5 C.BREAKER AND EXTERNAL NEUTRAL WITH ADVANCED ELECTRONIC RELAY AND VOLTAGE SOCKETS ON PHASES AND NEUTRAL EXTERNAL TO C.BREAKER (ONLY FOR XT5 C. BREAKERS)

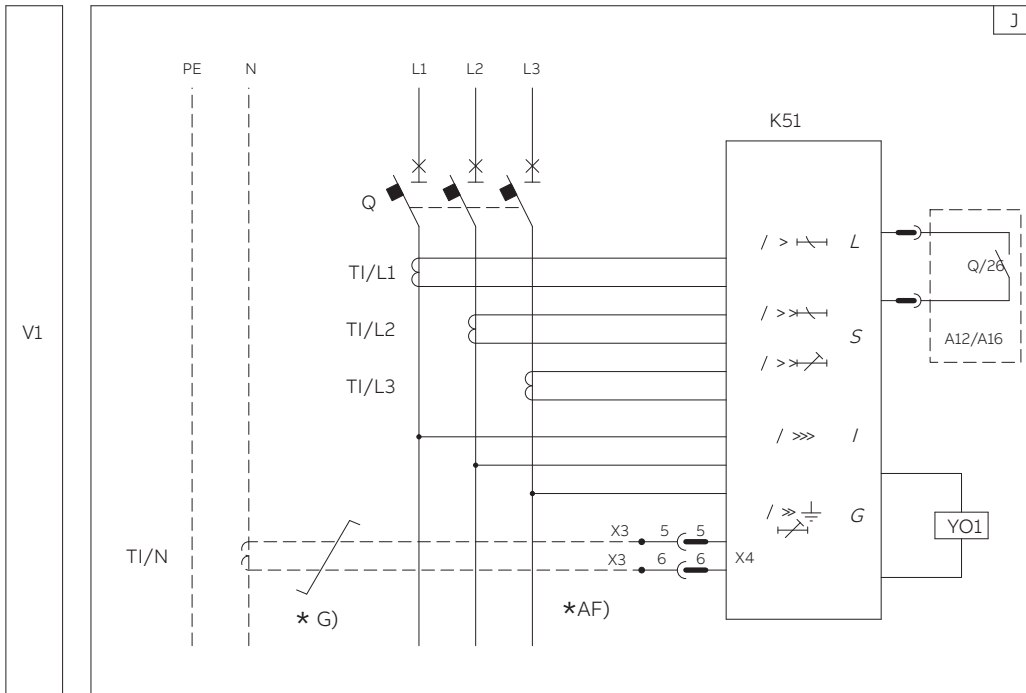

Ekip Touch LSI
Ekip Touch LSIG
Ekip Touch Measuring LSI
Ekip Touch Measuring LSIG
Ekip Hi-Touch LSI
Ekip Hi-Touch LSIG

* E)

INTERRUTTORE TRIPOLARE XT5 IN ESECUZIONE FISSA CON RELE' ELETTRONICO EVOLUTO E CON TRASFORMATORE DI CORRENTE E PRESA DI TENSIONE SU CONDOTTORE NEUTRO ESTERNO ALL'INTERRUTTORE (SOLO PER INTERRUTTORI XT5)
 FIXED VERSION 3-POLE XT5 C.BREAKER WITH ADVANCED ELECTRONIC RELAY AND WITH CURRENT TRANSFORMER AND VOLTAGE SOCKET ON NEUTRAL CONDUCTOR, EXTERNAL TO C.BREAKER (ONLY FOR XT5 C. BREAKERS)

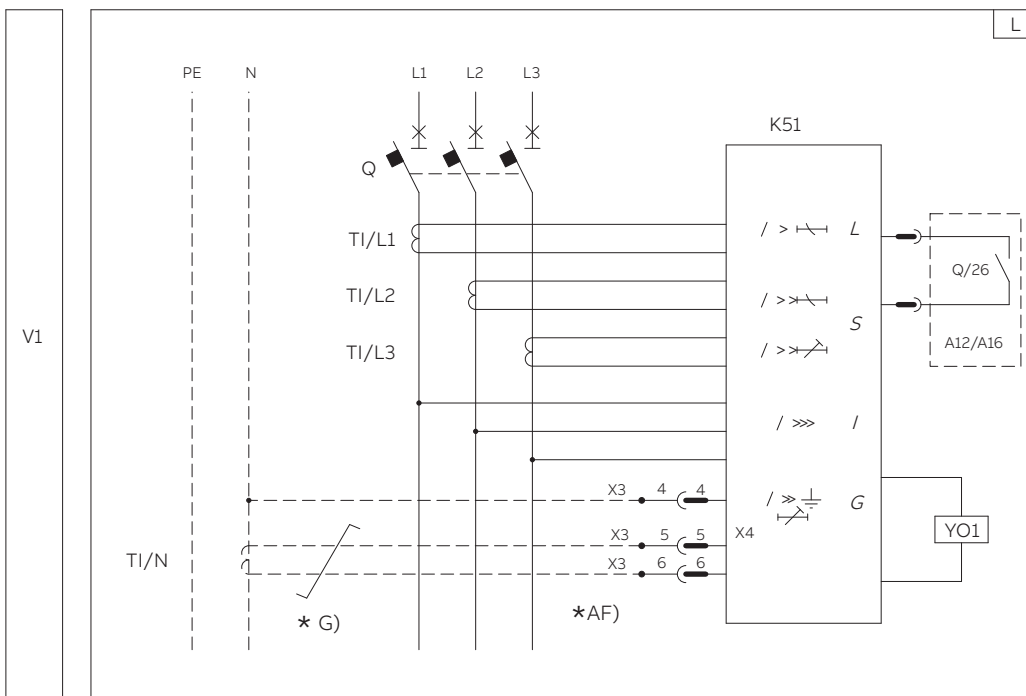

Ekip Touch LSI
Ekip Touch LSIG
Ekip Touch Measuring LSI
Ekip Touch Measuring LSIG
Ekip Hi-Touch LSI
Ekip Hi-Touch LSIG

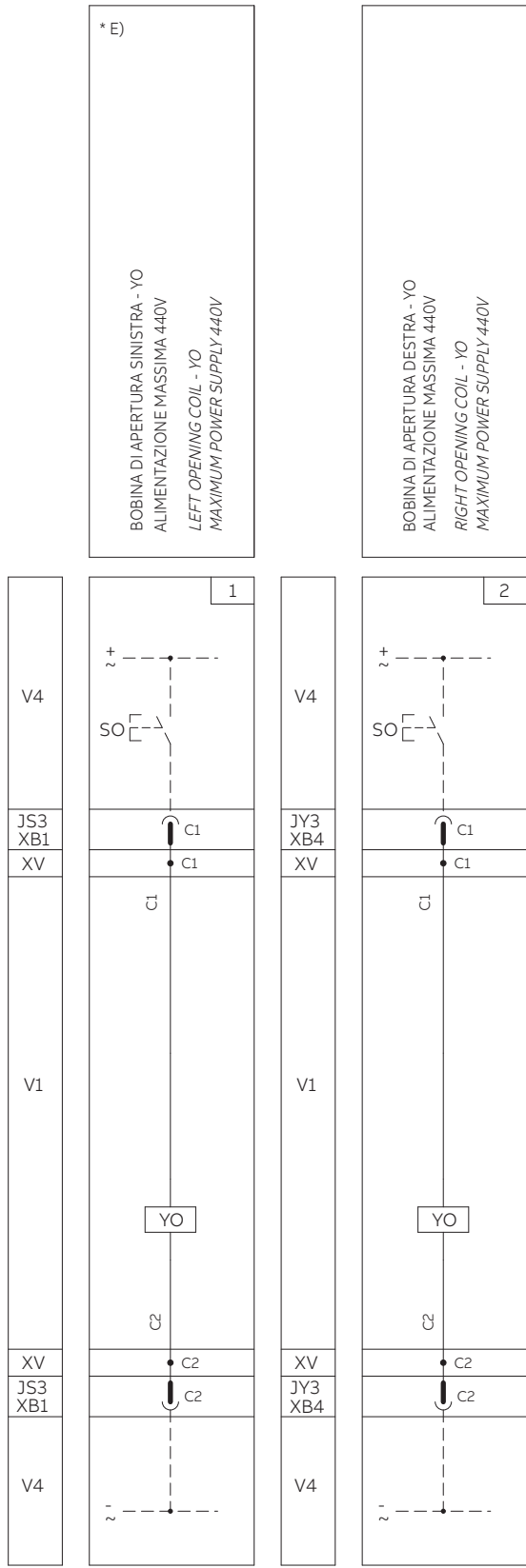

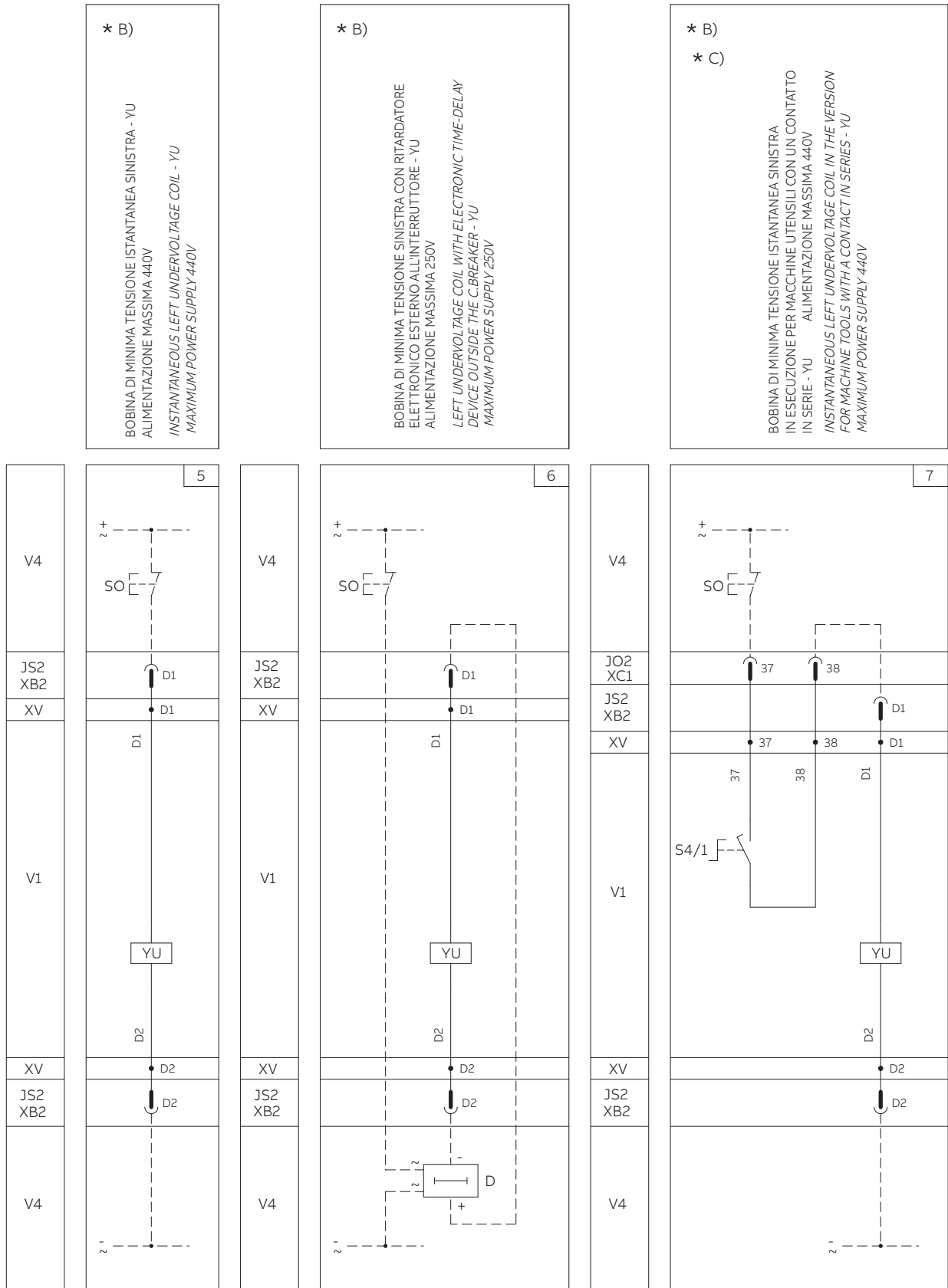

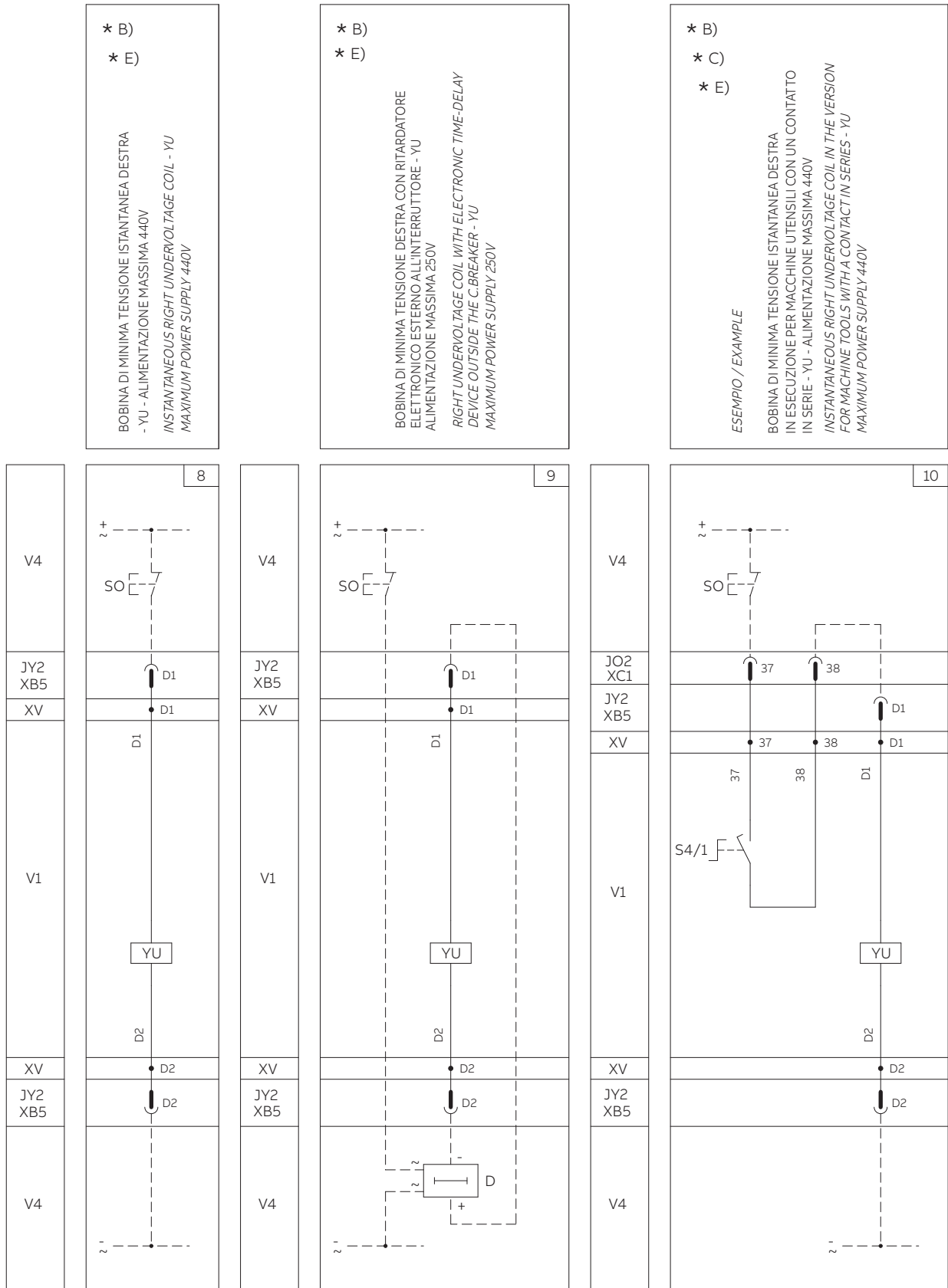

* E)

BOBINA DI APERTURA SINISTRA - YO
 CON CONVERTITORE DI TENSIONE
 ESTERNO ALL'INTERRUTTORE
 ALIMENTAZIONE 480...525Vac
 LEFT OPENING COIL - YO
 WITH VOLTAGE CONVERTER
 EXTERNAL TO THE BREAKER
 POWER SUPPLY: 480Vac...525Vac

BOBINA DI APERTURA DESTRA - YO
 CON CONVERTITORE DI TENSIONE
 ESTERNO ALL'INTERRUTTORE
 ALIMENTAZIONE 480...525Vac
 RIGHT OPENING COIL - YO
 WITH VOLTAGE CONVERTER
 EXTERNAL TO THE BREAKER
 POWER SUPPLY: 480Vac...525Vac

* B)

BOBINA DI MINIMA TENSIONE SINISTRA - YU
 CON CONVERTITORE DI TENSIONE
 ESTERNO ALL'INTERRUTTORE
 ALIMENTAZIONE 480...525Vac
 LEFT UNDERVOLTAGE COIL - YU
 WITH VOLTAGE CONVERTER
 EXTERNAL TO THE BREAKER
 POWER SUPPLY: 480Vac...525Vac

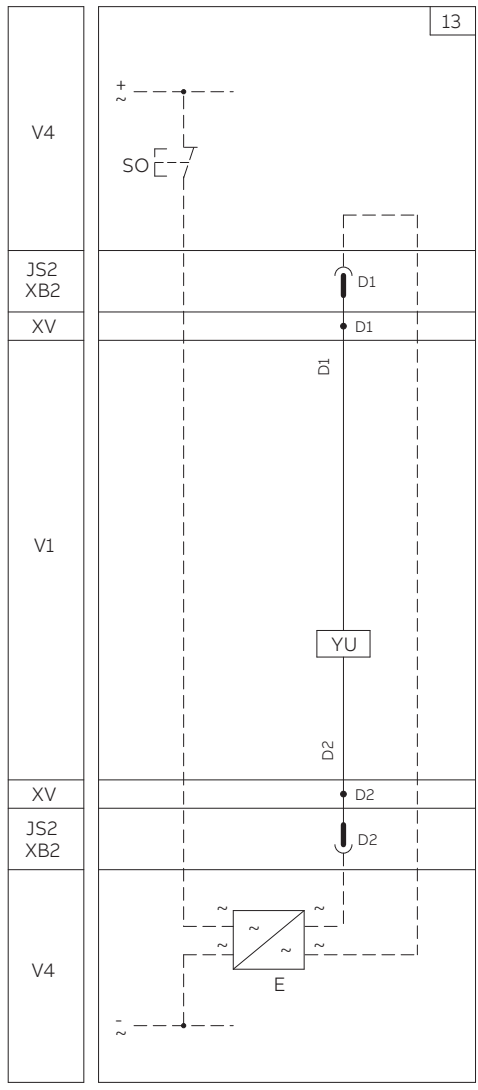
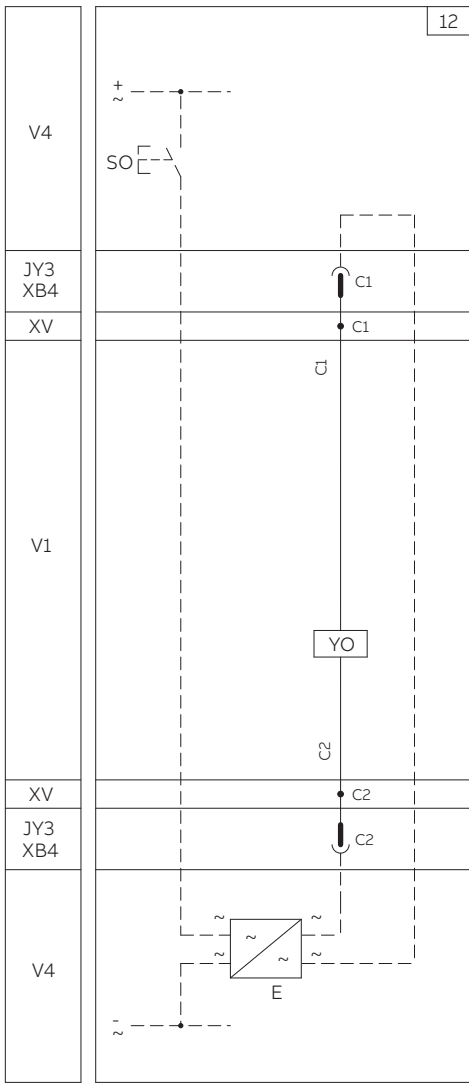
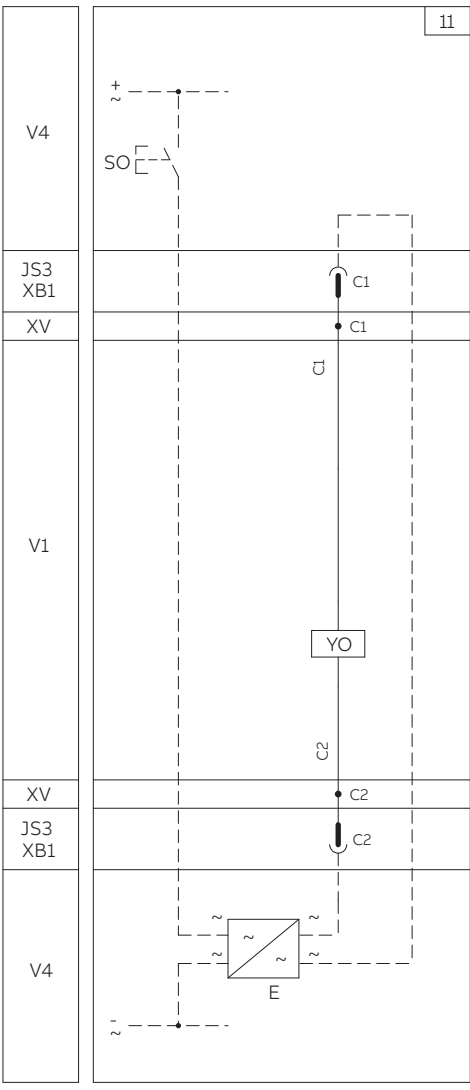

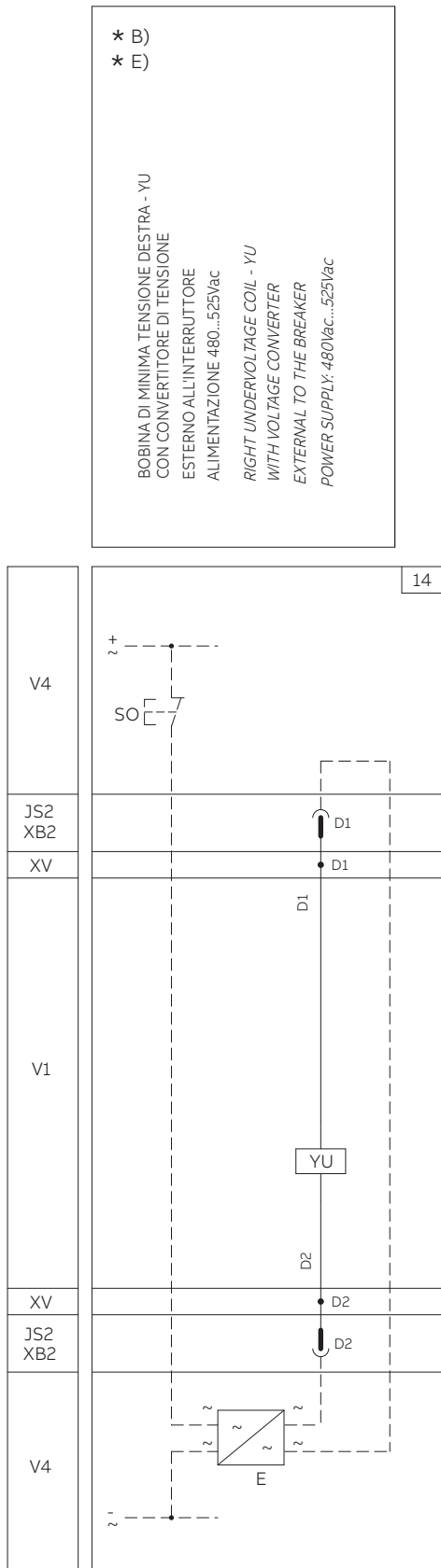

* B)
* E)

BOBINA DI MINIMA TENSIONE DESTRA - YU
CON CONVERTITORE DI TENSIONE
ESTERNO ALL'INTERRUTTORE
ALIMENTAZIONE 480...525Vac

RIGHT UNDERVOLTAGE COIL - YU
WITH VOLTAGE CONVERTER
EXTERNAL TO THE BREAKER
POWER SUPPLY: 480Vac...525Vac

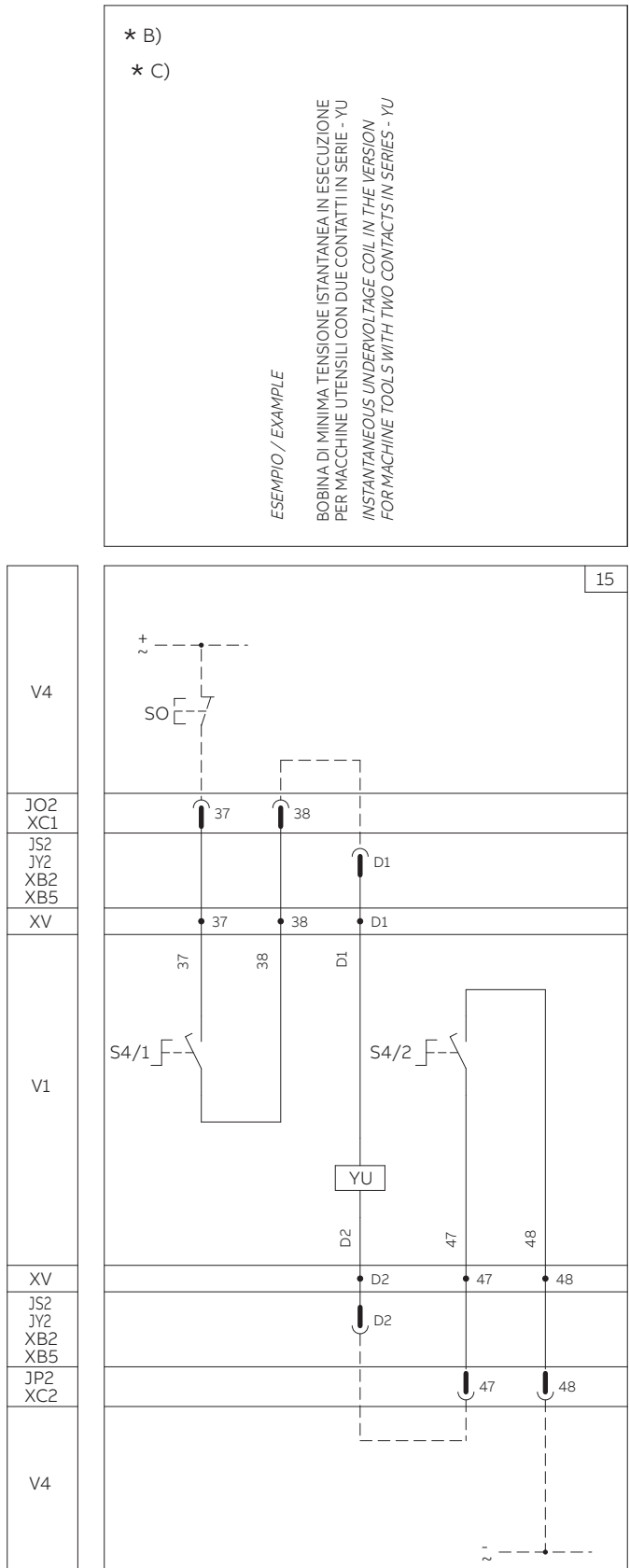

* B)
* C)

ESEMPIO / EXAMPLE

BOBINA DI MINIMA TENSIONE ISTANTANEA IN ESECUZIONE
PER MACCHINE UTENSILI CON DUE CONTATTI IN SERIE - YU
INSTANTANEOUS UNDERVOLTAGE COIL IN THE VERSION
FOR MACHINE TOOLS WITH TWO CONTACTS IN SERIES - YU

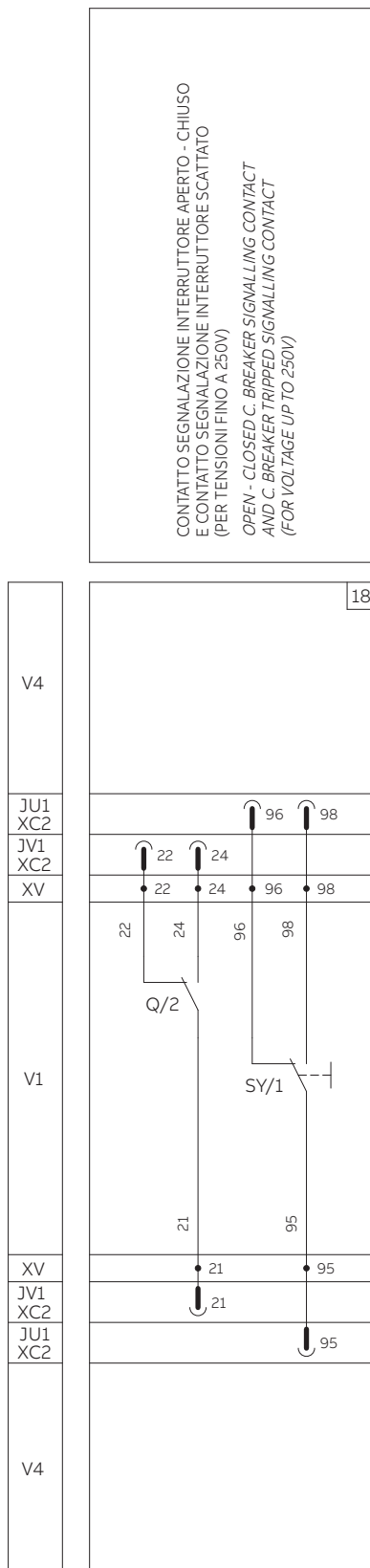

CONTATTO SEGNALE INTERUTTORE APERTO - CHIUSO
 E CONTATTO SEGNALE INTERUTTORE SCATTATO
 (PER TENSIONI FINO A 250V)
 OPEN - CLOSED C. BREAKER SIGNALLING CONTACT
 AND C. BREAKER TRIPPED SIGNALLING CONTACT
 (FOR VOLTAGE UP TO 250V)

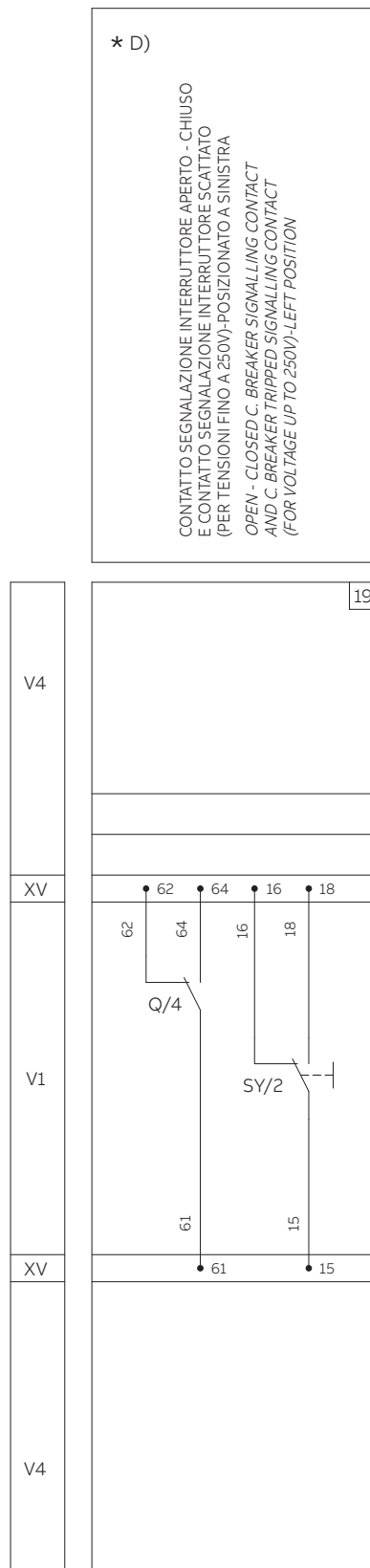

* D)
 CONTATTO SEGNALE INTERUTTORE APERTO - CHIUSO
 E CONTATTO SEGNALE INTERUTTORE SCATTATO
 (PER TENSIONI FINO A 250V)-POSIZIONATO A SINISTRA
 OPEN - CLOSED C. BREAKER SIGNALLING CONTACT
 AND C. BREAKER TRIPPED SIGNALLING CONTACT
 (FOR VOLTAGE UP TO 250V)-LEFT POSITION

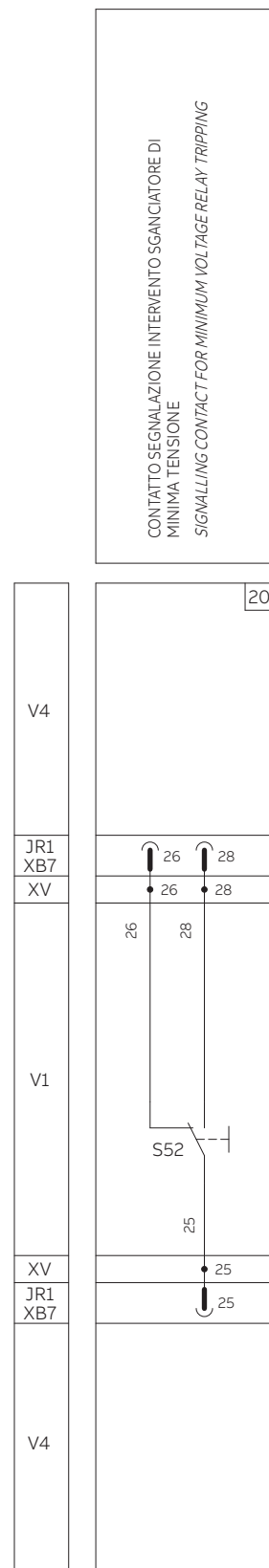

CONTATTO SEGNALE INTERVENTO SGANCIAZIONE DI
 MINIMA TENSIONE
 SIGNALLING CONTACT FOR MINIMUM VOLTAGE RELAY TRIPPING

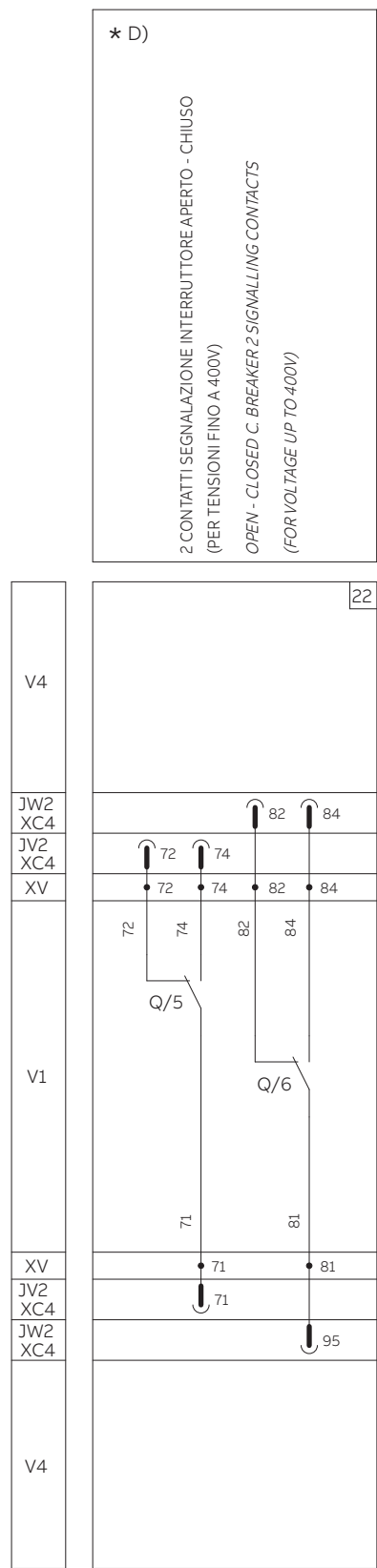
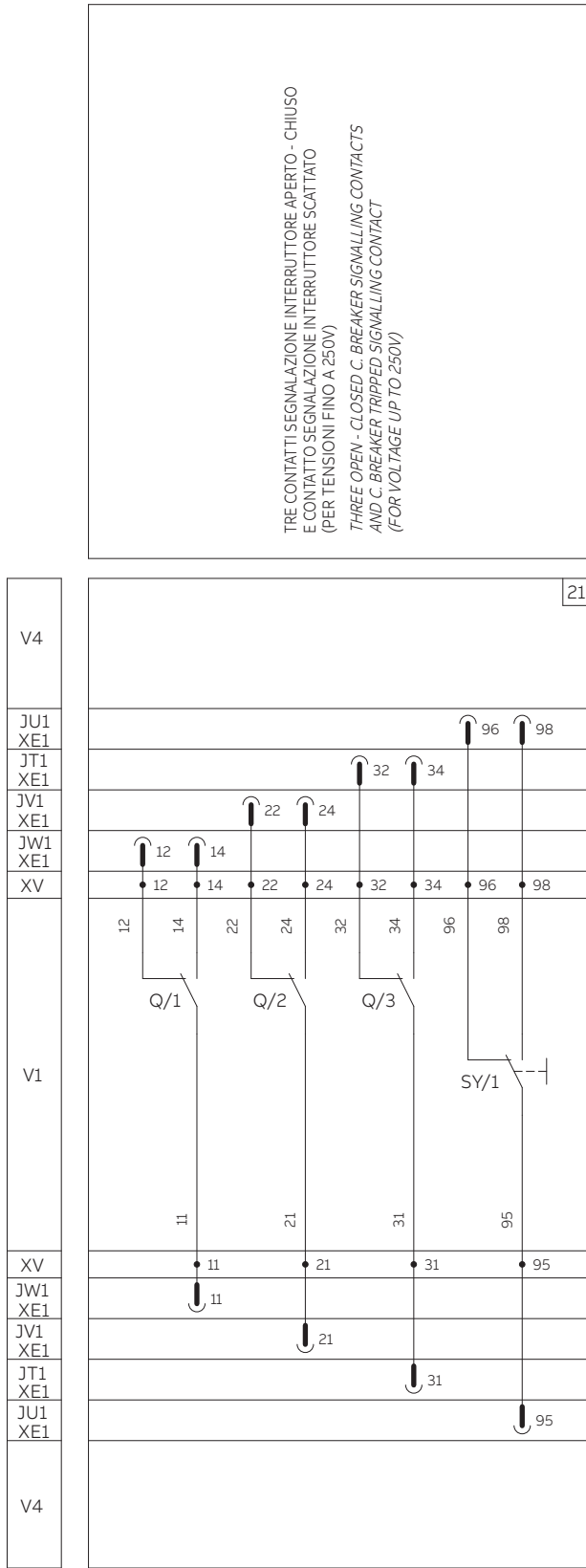

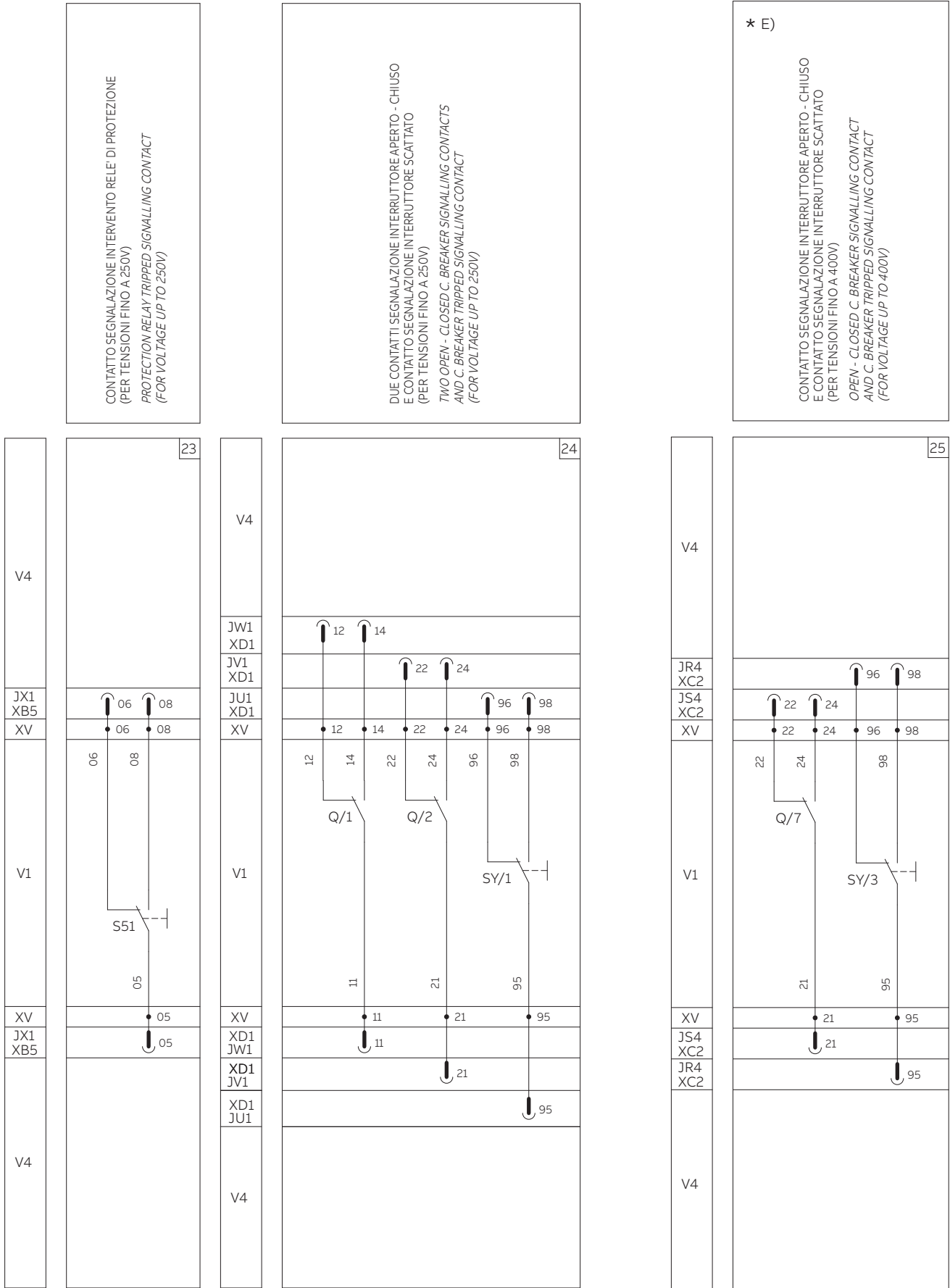

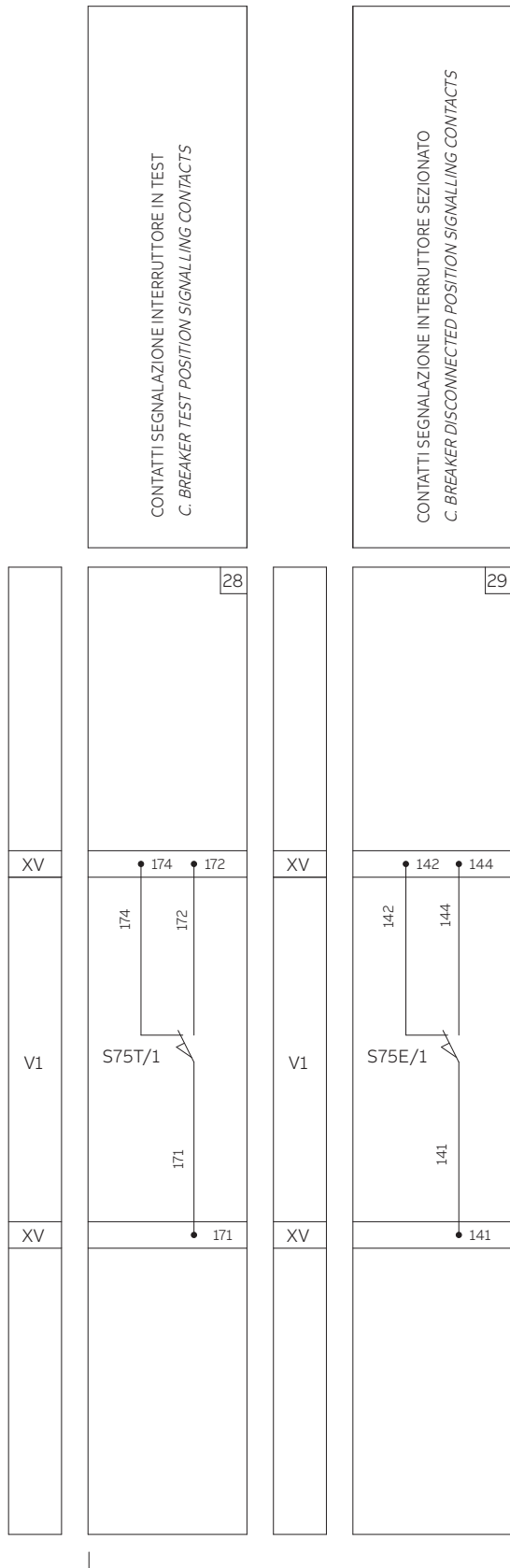

CONTATTI SEGNALAZIONE INTERRUTTORE IN TEST
C. BREAKER TEST POSITION SIGNALLING CONTACTS

CONTATTI SEGNALAZIONE INTERRUTTORE SEZIONATO
C. BREAKER DISCONNECTED POSITION SIGNALLING CONTACTS

SOLO PER INTERRUTTORI IN ESECUZIONE ESTRAIBILE
ONLY FOR WITHDRAWABLE VERSION C.BREAKER

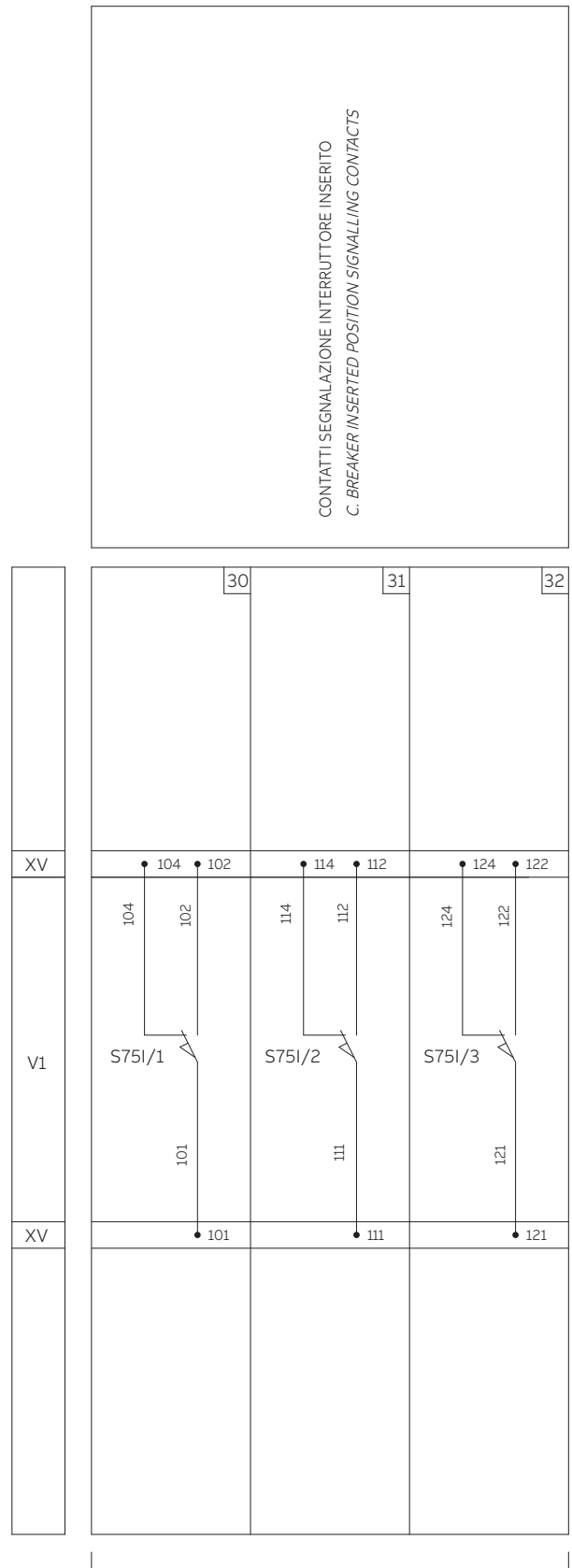

CONTATTI SEGNALAZIONE INTERRUTTORE INSERITO
C. BREAKER INSERTED POSITION SIGNALLING CONTACTS

SOLO PER INTERRUTTORI IN ESECUZIONE RIMOVIBILE O ESTRAIBILE
ONLY FOR PLUG-IN OR WITHDRAWABLE VERSION C.BREAKER

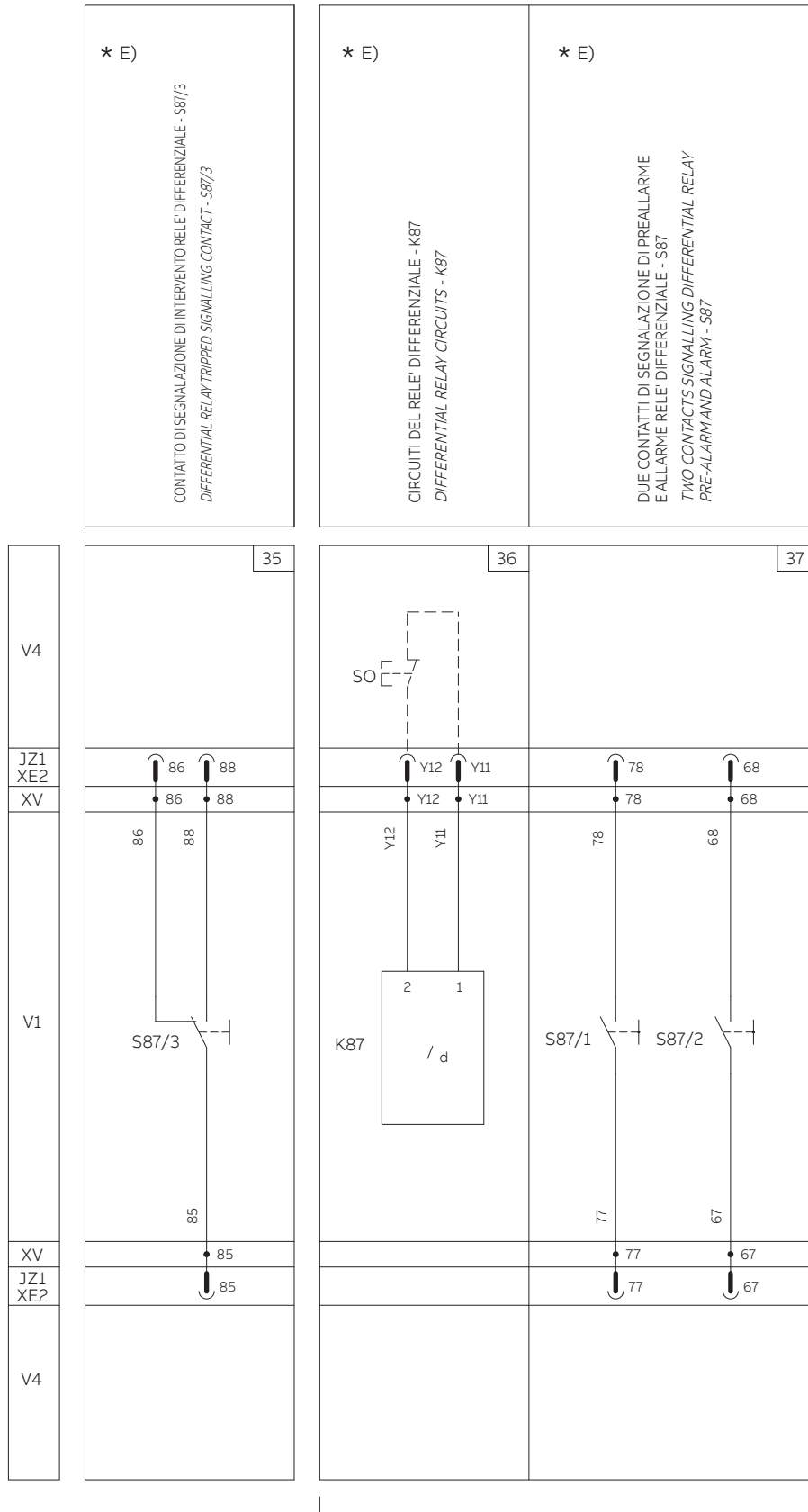

SOLO PER RELE' DIFFERENZIALI TIPO RC Sel XT5 4 POLI
 ONLY FOR DIFFERENTIAL RELAY TYPE RC Sel XT5 4 POLES

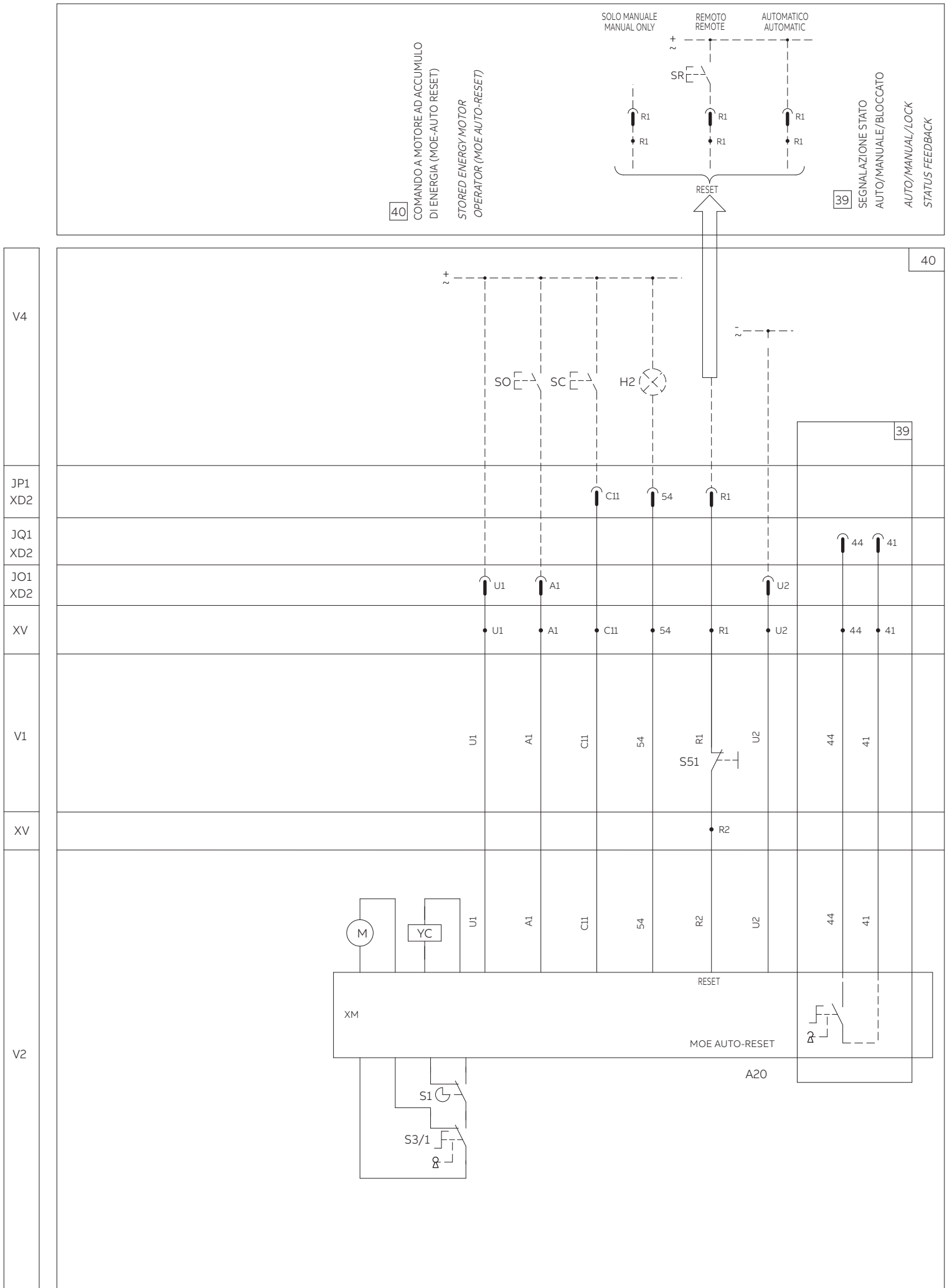

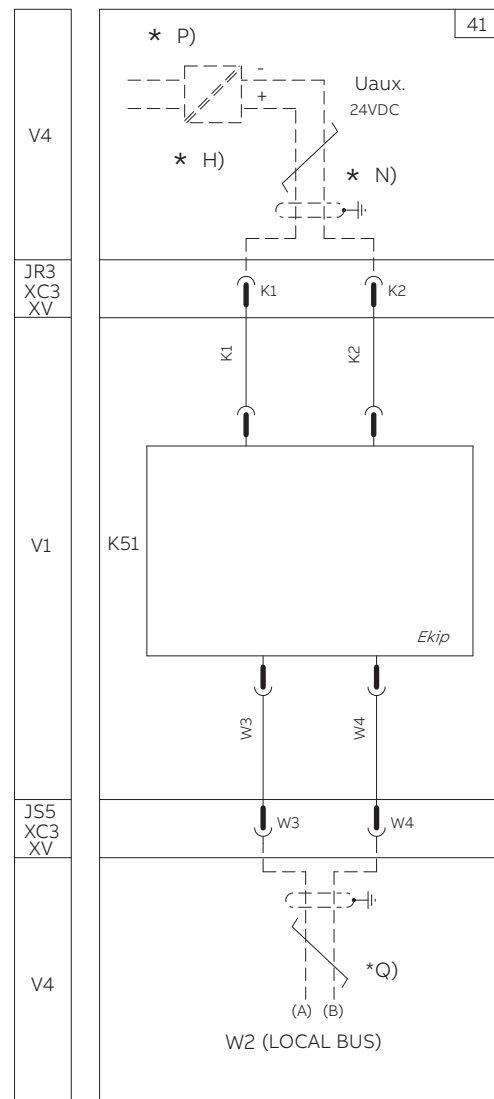
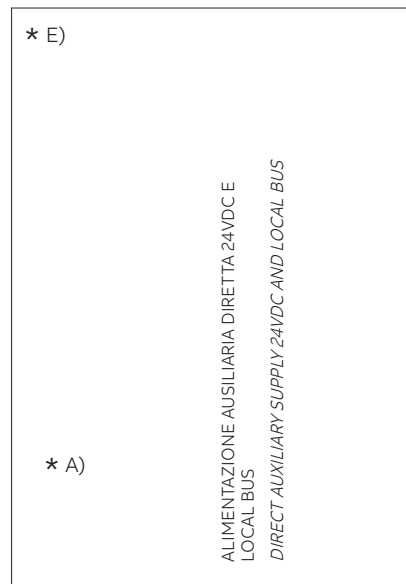
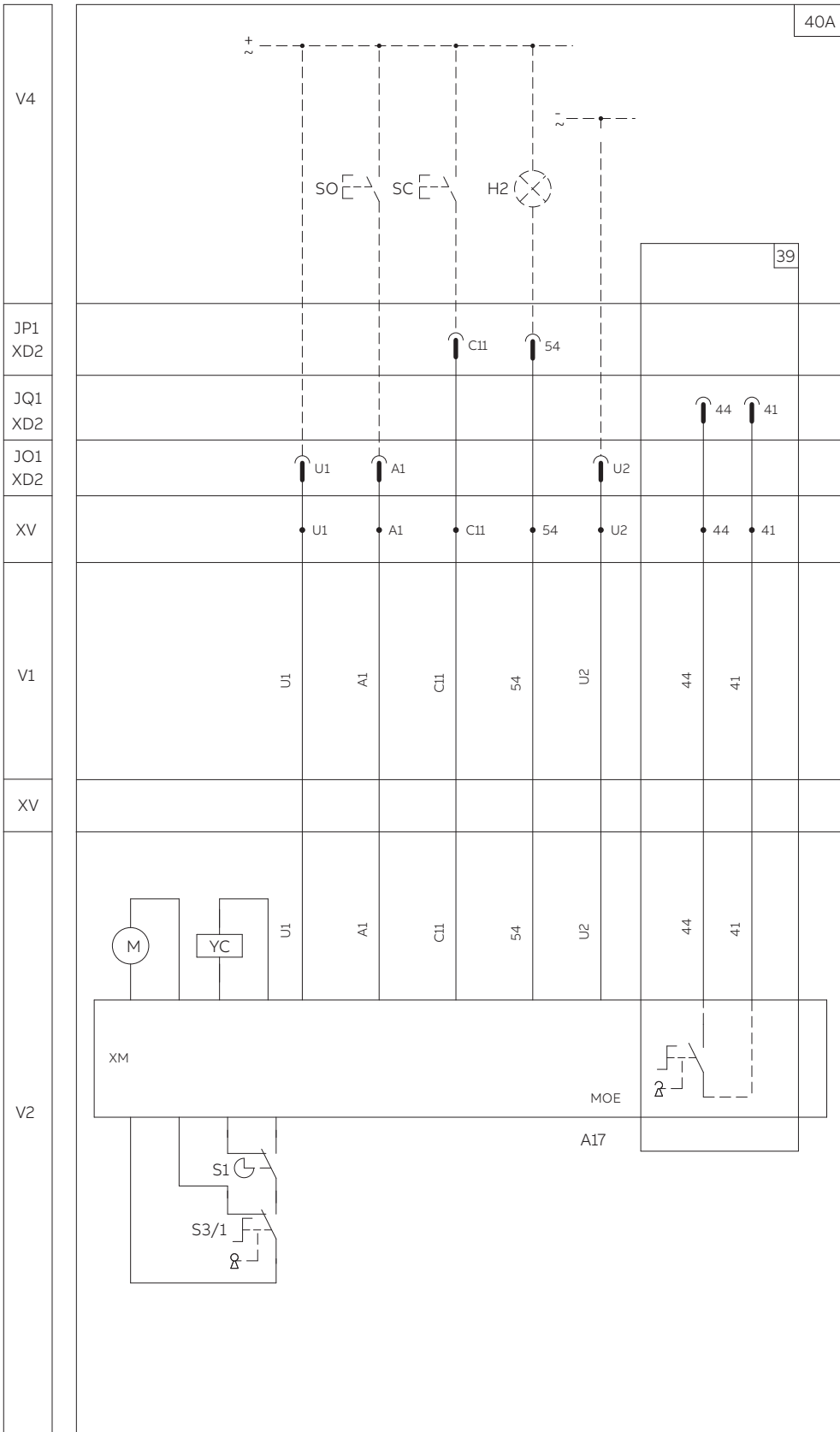

IN ALTERNATIVA ALLA FIGURA 78
AS AN ALTERNATIVE TO FIGURE 78

* E)

UNITA DI INTERFACCIA TIPO Ekip Com
INTERFACE UNIT TYPE Ekip Com

42

V4

* Q)

W2 (LOCAL BUS)

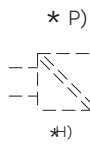

W2

JR3
XC3
JS5
XC3
XV

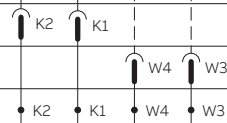

V1

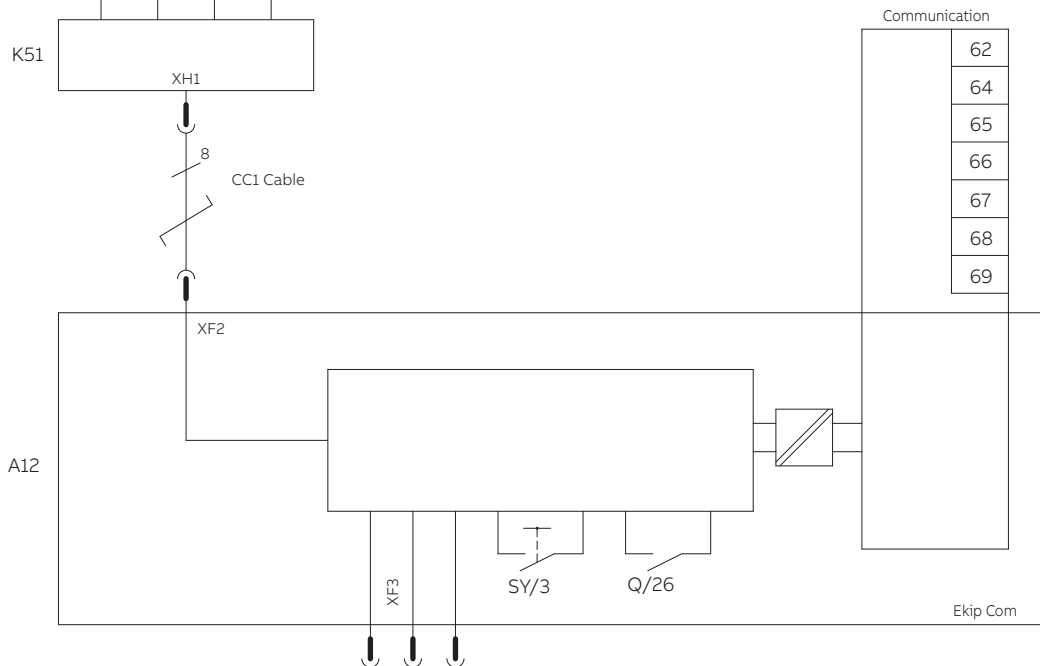

* E)

UNITA' DI INTERFACCIA TIPO Ekip Com
STAND ALONE
STAND ALONE INTERFACE UNIT
TYPE Ekip Com

43

V4

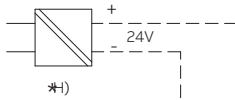

JR2
XC7
XV

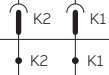

V1

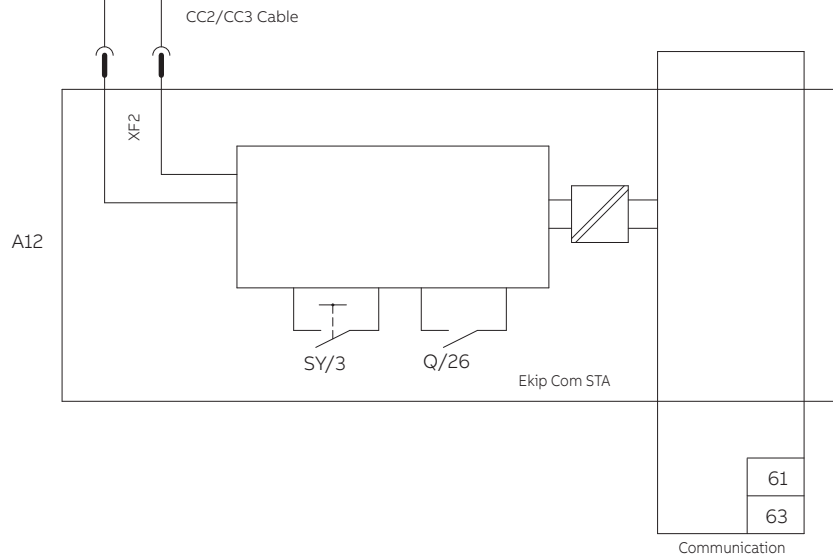

* E)

44

UNITA' DI INTERFACCIA TIPO Ekip Com
STAND ALONE CON COMANDO A
MOTORE MOE-E
STAND ALONE INTERFACE UNIT TYPE
Ekip Com WITH MOE-E MOTOR
OPERATOR

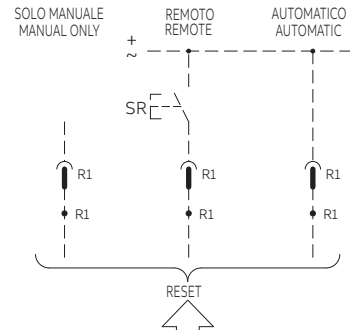

39

SEGNALAZIONE STATO
AUTO/MANUALE/BLOCCATO
AUTO/MANUAL/LOCK
STATUS FEEDBACK

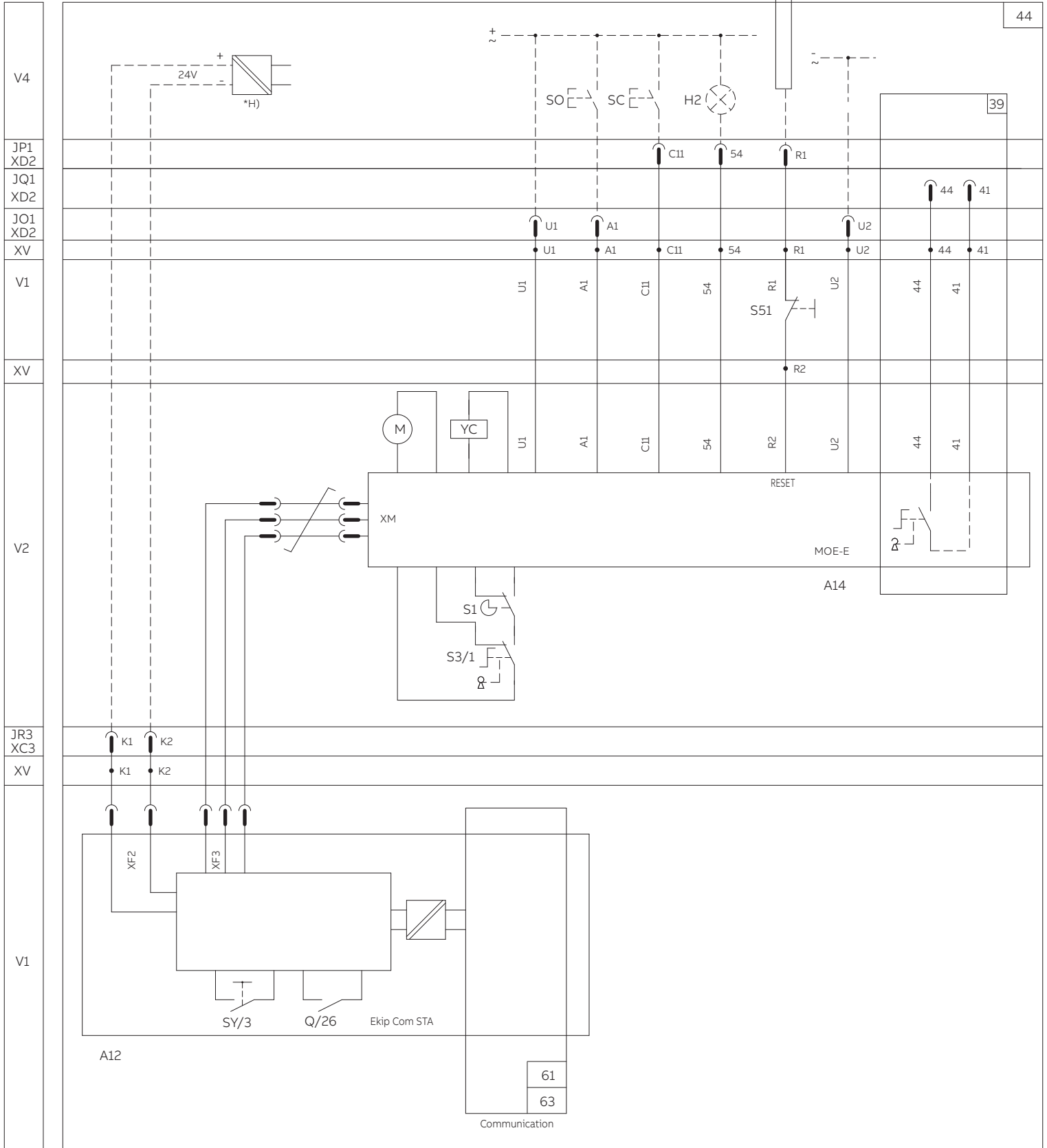

* E)

45

UNITA' DI INTERFACCIA TIPO Ekip Com
 CON ALIMENTAZIONE DIRETTA AL RELE'
 E COMANDO A MOTORE MOE-E
 INTERFACE UNIT TYPE Ekip Com
 WITH DIRECT SUPPLY TO RELAY AND
 MOE-E MOTOR OPERATOR

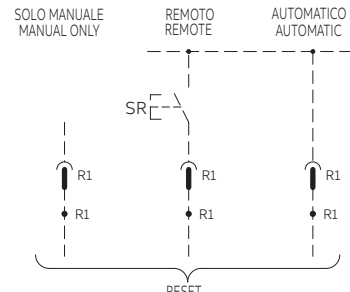

39

SEGNALAZIONE STATO
 AUTO/MANUALE/BLOCCATO
 AUTO/MANUAL/LOCK
 STATUS FEEDBACK

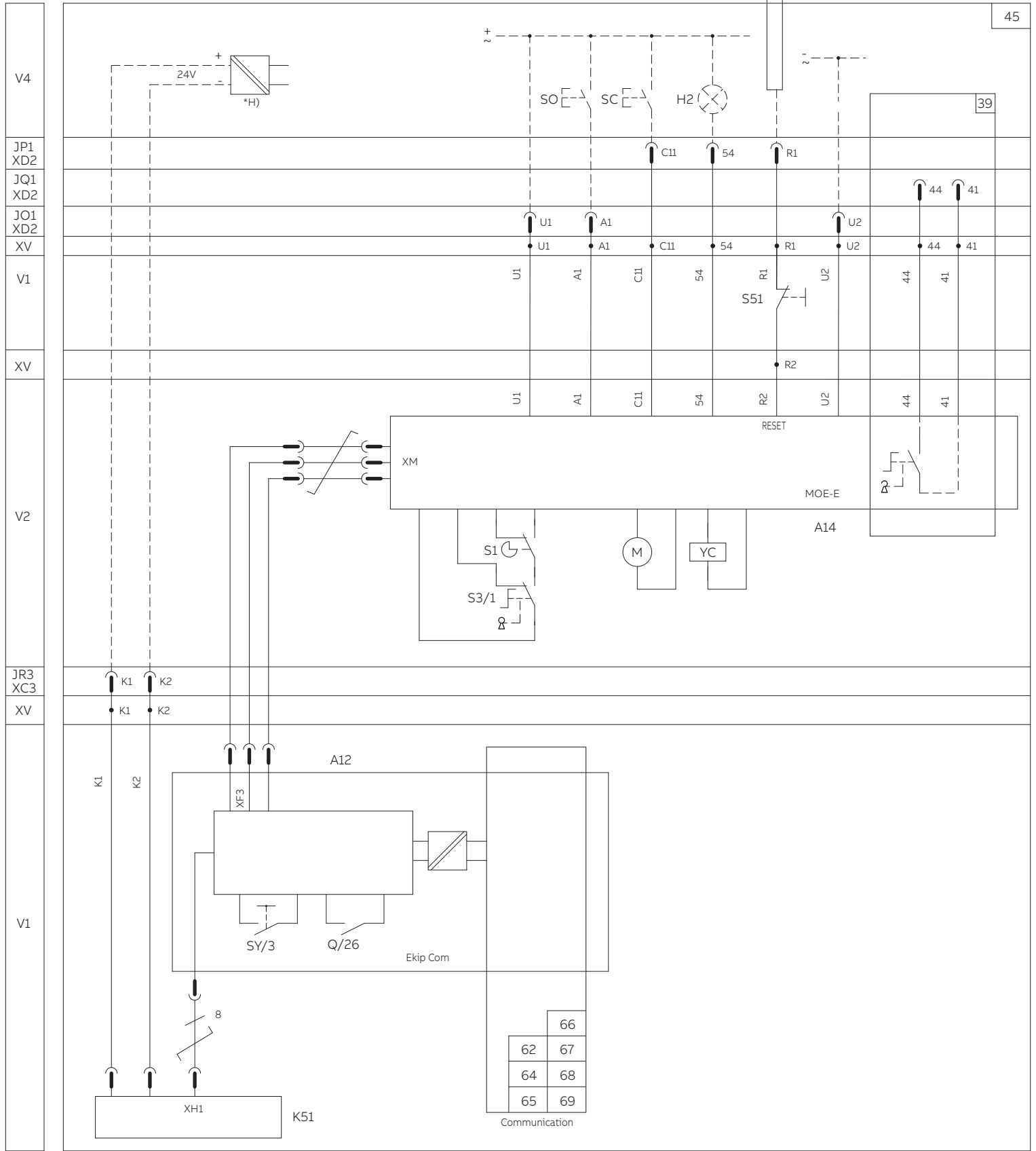

* E)

46 UNITA DI INTERFACCIA TIPO Ekip Micro Module I/O
 CON COMANDO A MOTORE MOE-E
 INTERFACE UNIT TYPE Ekip Micro Module I/O
 WITH MOE-E MOTOR OPERATOR

73 Ekip MICRO MODULE I/O

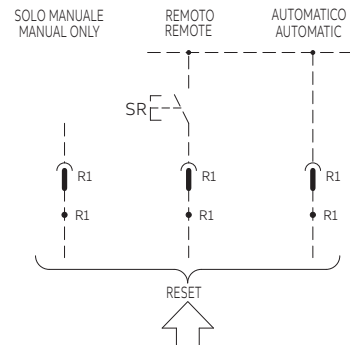

39 SEGNALAZIONE STATO
 AUTO/MANUALE/BLOCCATO
 AUTO/MANUAL/LOCK
 STATUS FEEDBACK

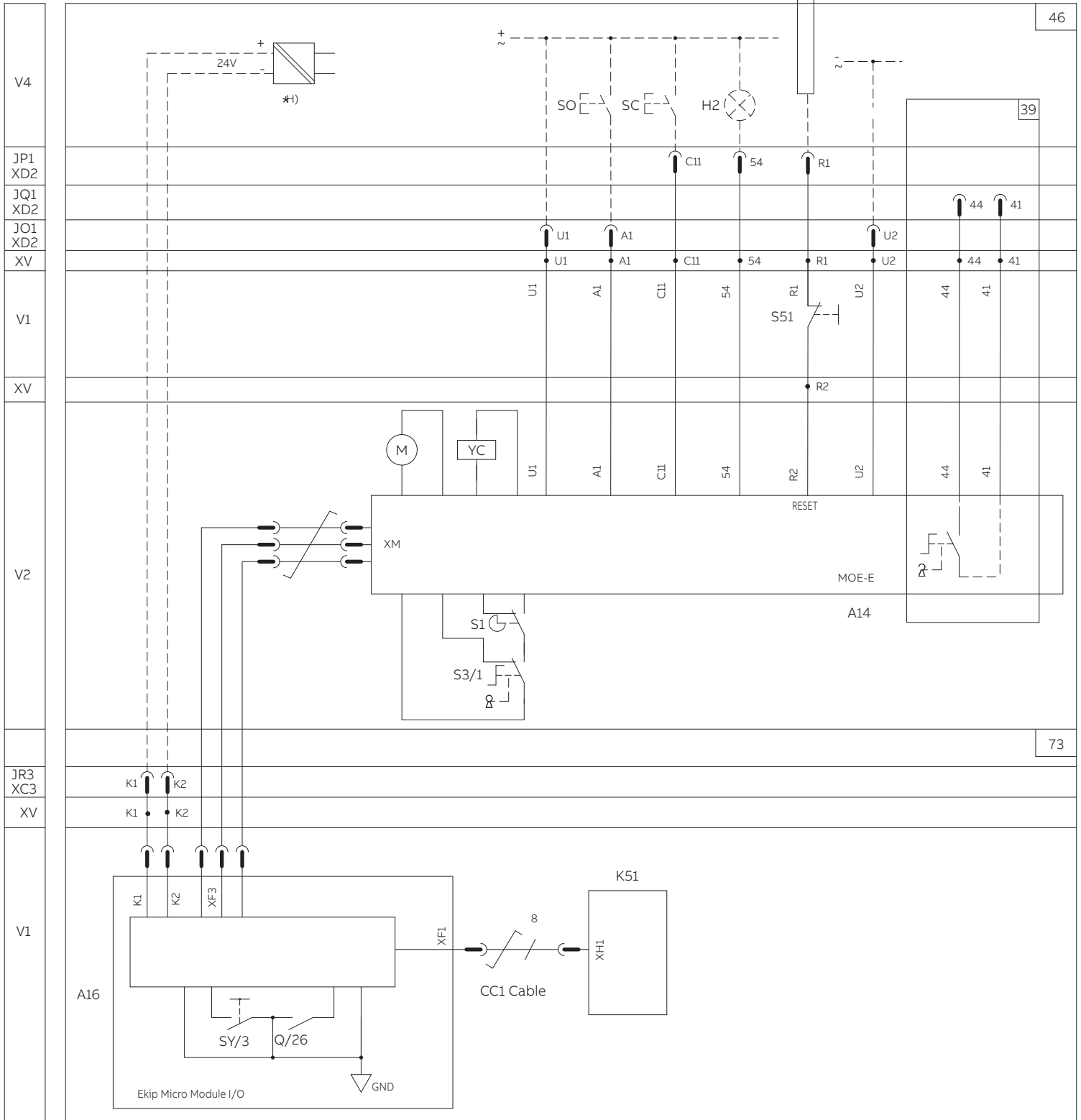

* A)
 * AB)
 * E)
 SELETTIVITA' DI ZONA
 ZONE SELECTIVITY

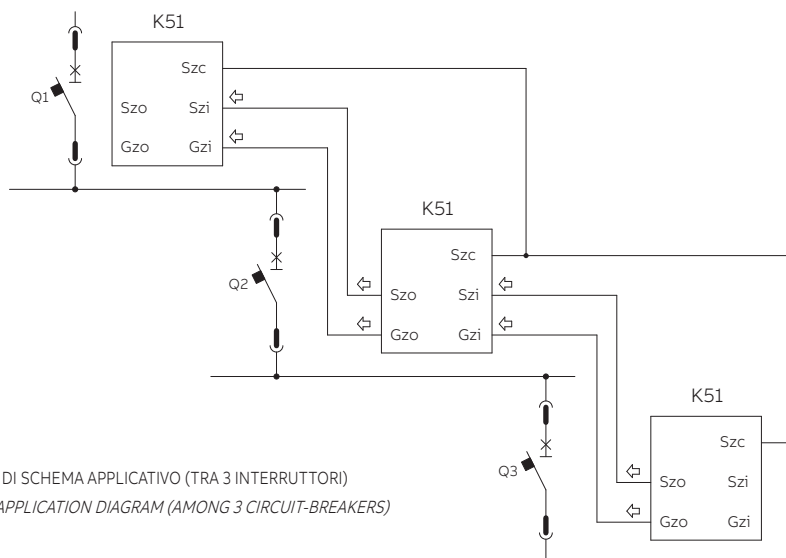
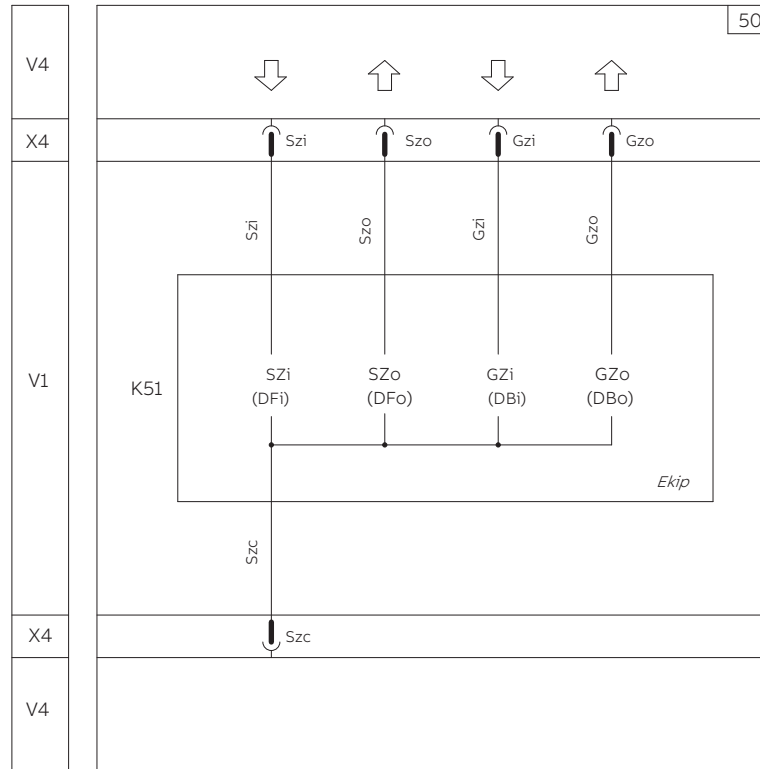

ESEMPIO DI SCHEMA APPLICATIVO (TRA 3 INTERRUTTORI)
 EXAMPLE FOR APPLICATION DIAGRAM (AMONG 3 CIRCUIT-BREAKERS)

* E)
 INTERFACCIA MODBUS RTU STA DELL'UNITA' EKIP COM
 MODBUS RTU STA INTERFACE OF EKIP COM UNIT

* E)
 INTERFACCIA MODBUS RTU DELL'UNITA' EKIP COM
 MODBUS RTU INTERFACE OF EKIP COM UNIT

* E)
 INTERFACCIA MODBUS TCP STA DELL'UNITA' EKIP COM
 MODBUS TCP STA INTERFACE OF EKIP COM UNIT

* E)
 INTERFACCIA DI COMUNICAZIONE DELL'UNITA'
 EKIP COM (VEDERE TABELLA SOTTO)
 COMMUNICATION INTERFACE OF EKIP COM UNIT
 (SEE TABLE BELOW)

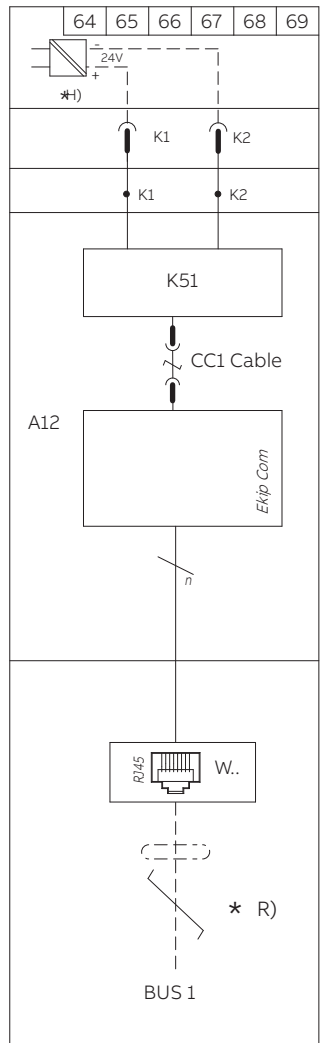
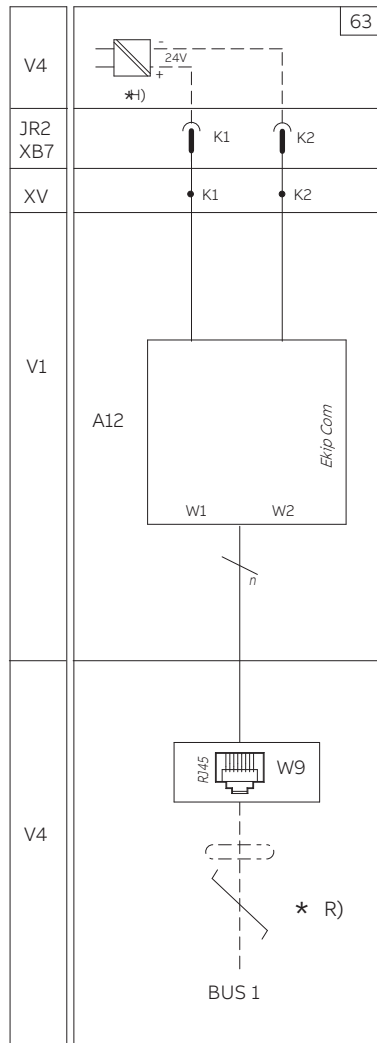
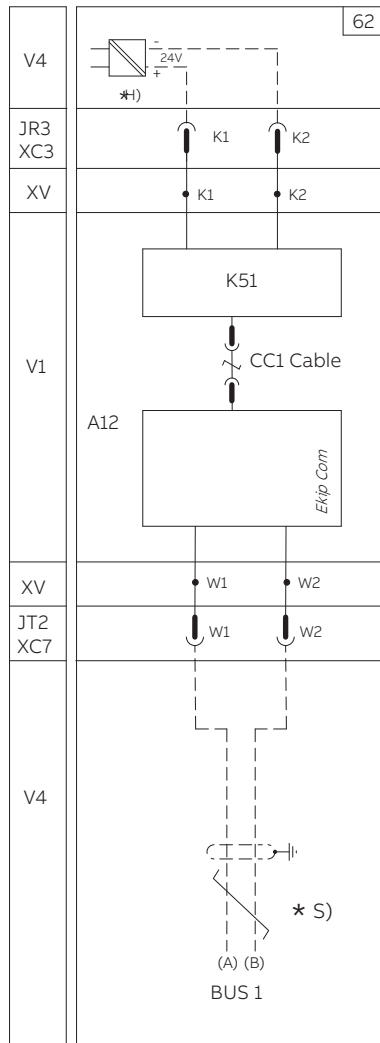
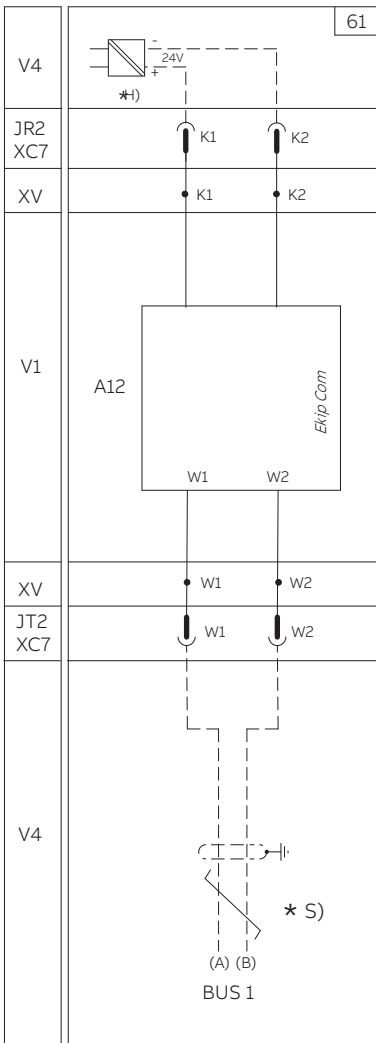
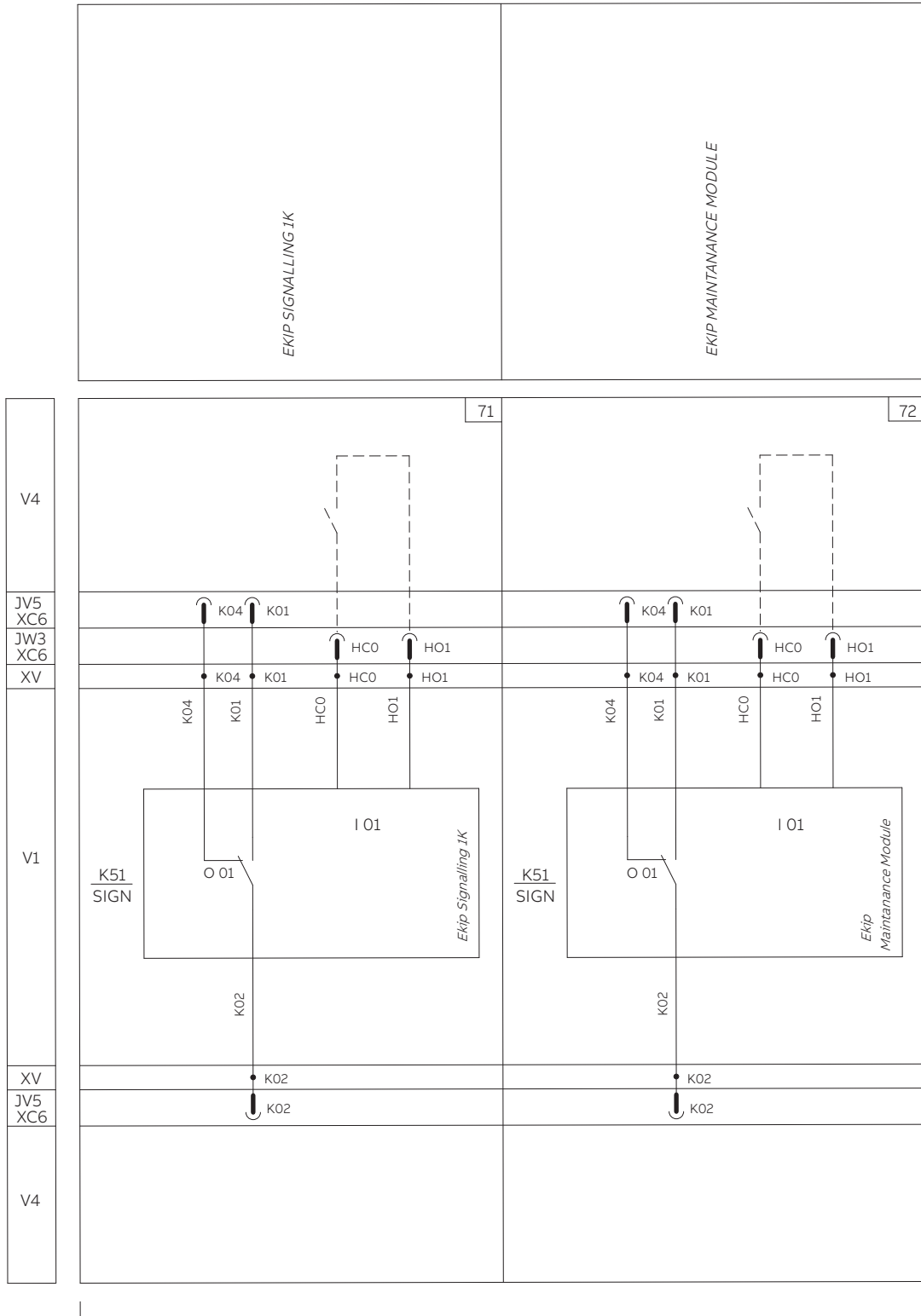
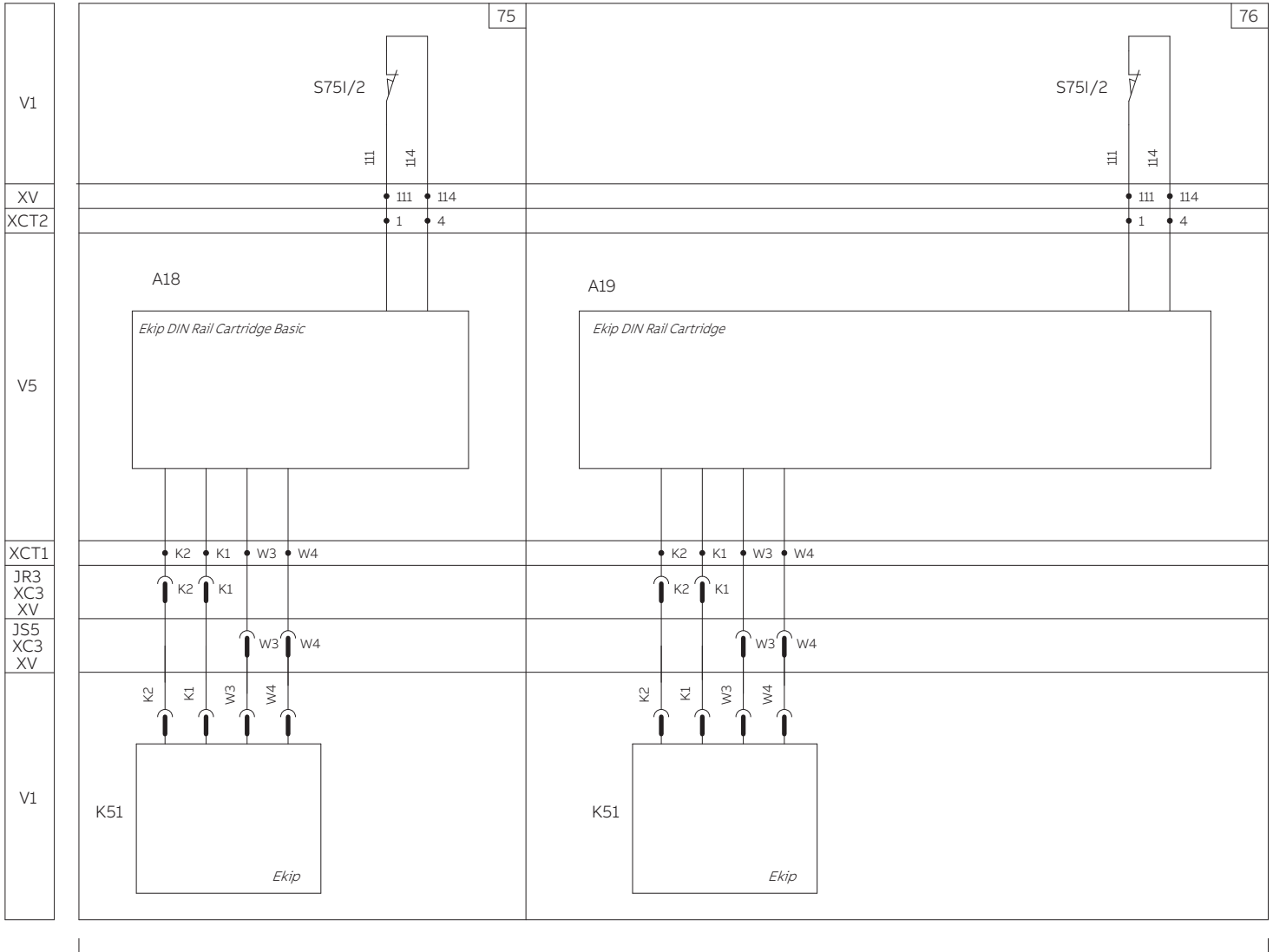
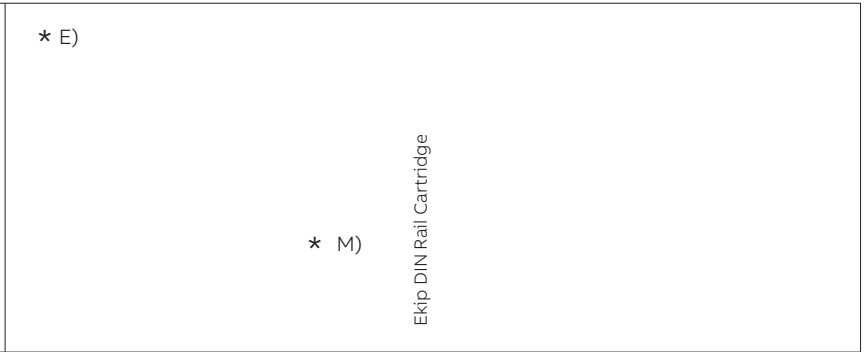
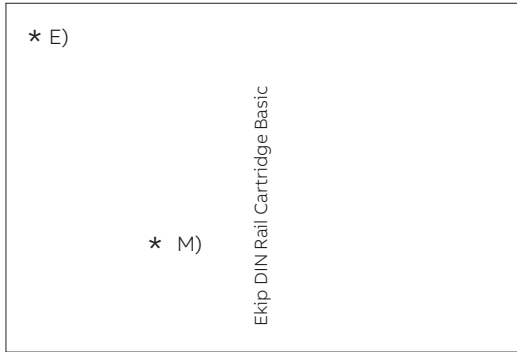
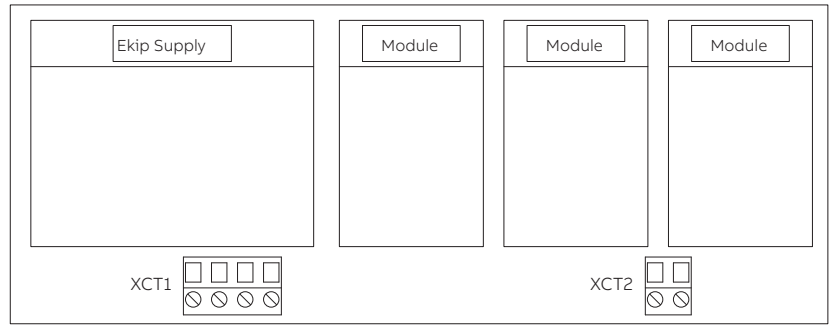
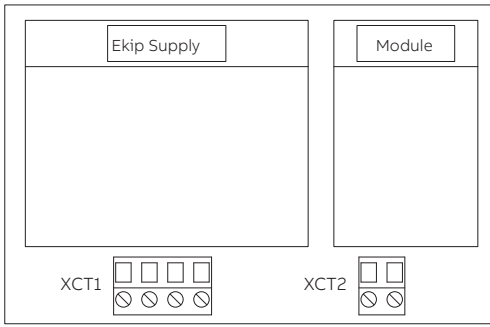

FIG.	DESCRIZIONE / DESCRIPTION	BUS
64	MODBUS TCP	W9
65	PROFINET	W10
66	ETHERNET I/P™	W11
67	IEC61850	W12
68	LINK	W13
69	HUB	W14

IN ALTERNATIVA TRA DI LORO
 AS IN ALTERNATIVE TO EACH OTHER



IN ALTERNATIVA TRA DI LORO
AS IN ALTERNATIVE TO EACH OTHER



IN ALTERNATIVA TRA DI LORO
AS IN ALTERNATIVE TO EACH OTHER

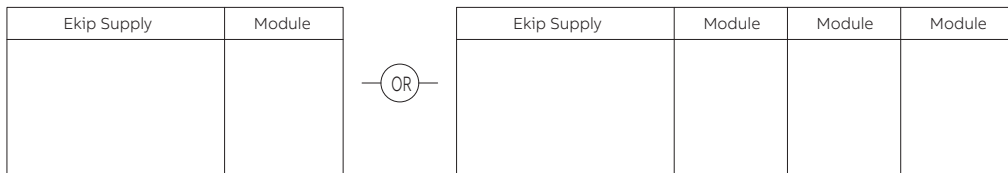

Ekip Supply 110-240VAC/DC
Ekip Supply 24-48VDC

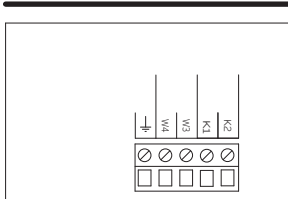

* AA)
* E)
* A)
* I)

ALIMENTAZIONE AUSILIARIA
TRAMITE MODULO 110-240VAC/DC
O 24-48VDC E LOCAL BUS
AUXILIARY SUPPLY THROUGH
MODULE 110-240VAC/DC OR
24-48VDC AND LOCAL BUS

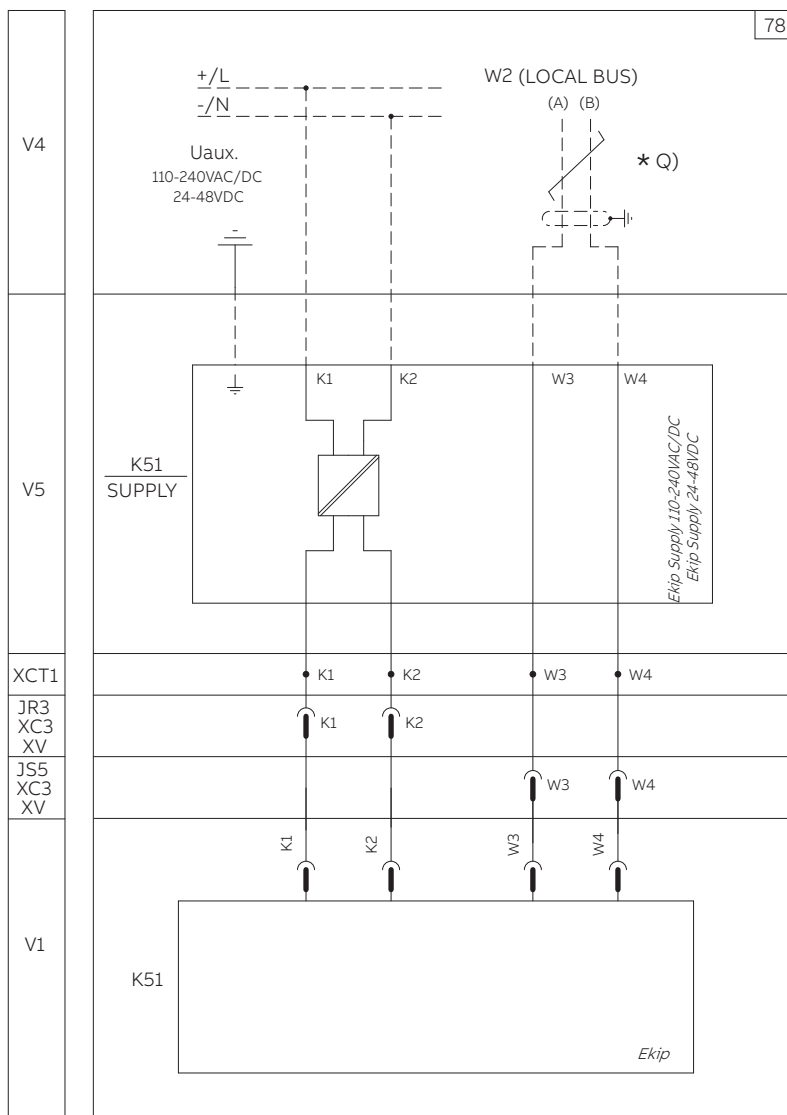

IN ALTERNATIVA ALLA FIGURA 41
AS AN ALTERNATIVE TO FIGURE 41

Ekip DIN Rail Cartridge Basic

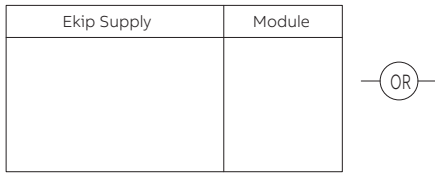

Ekip DIN Rail Cartridge

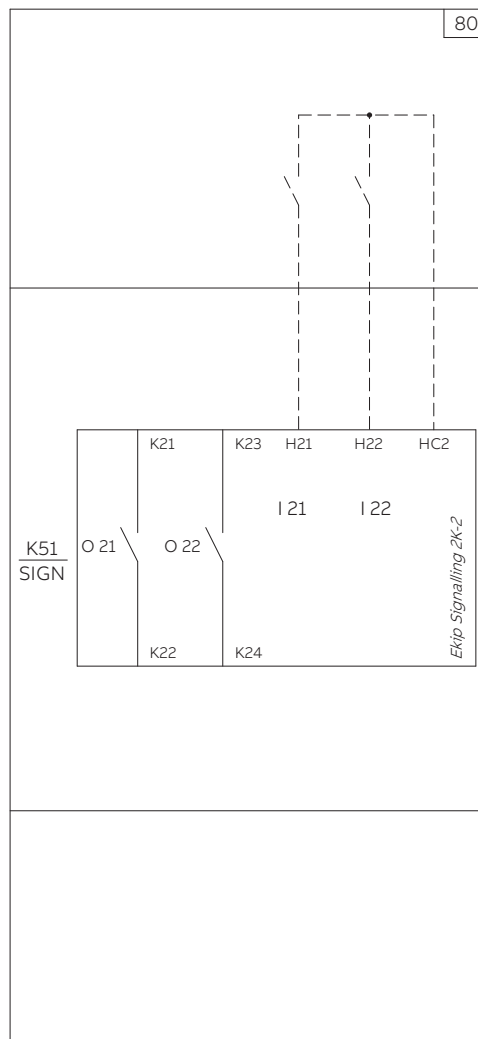
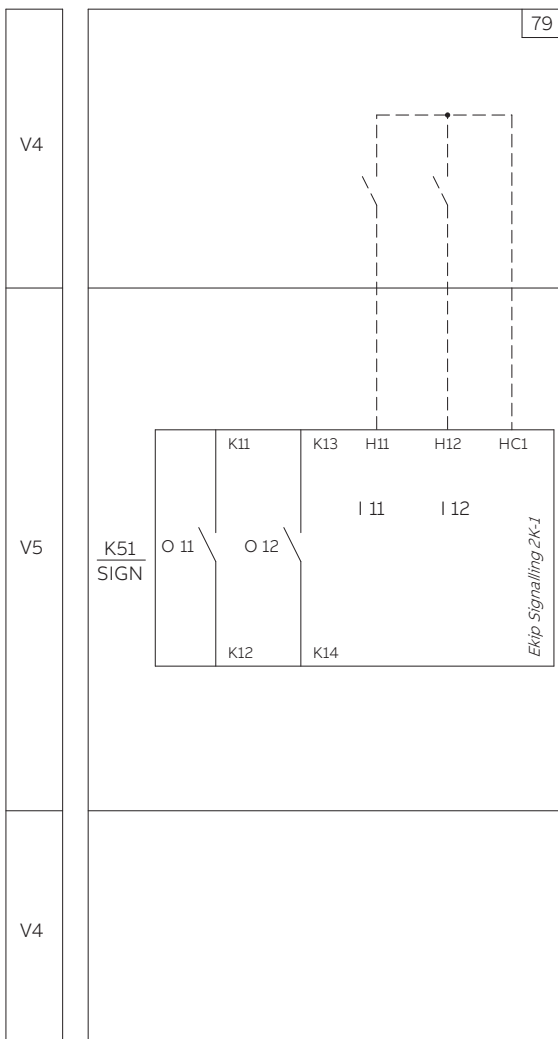
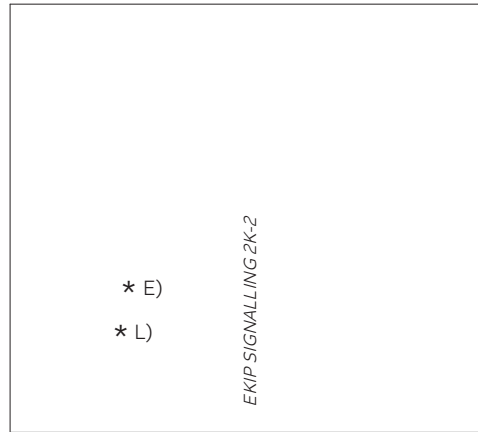
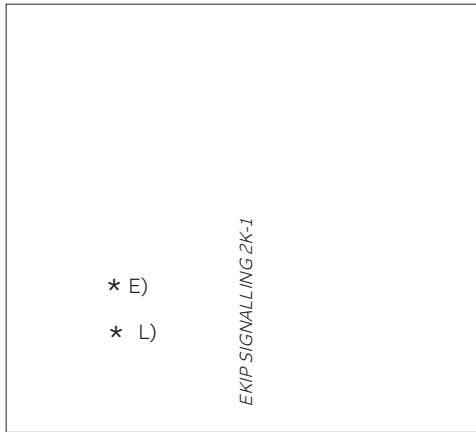
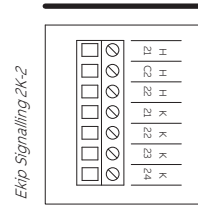
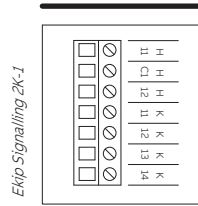
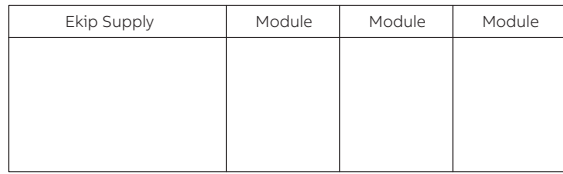

Ekip DIN Rail Cartridge Basic

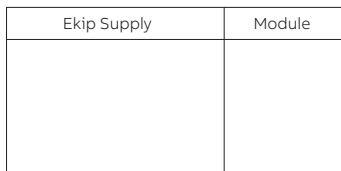

OR

Ekip DIN Rail Cartridge

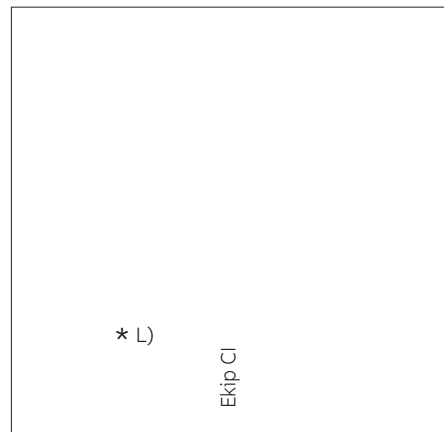
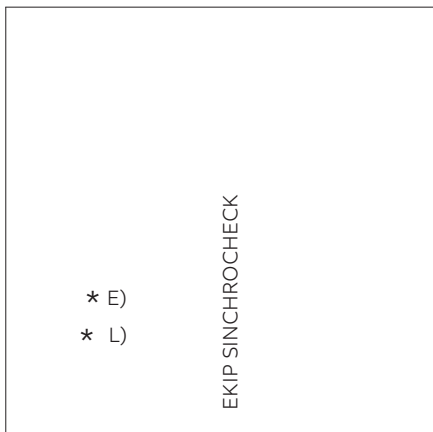
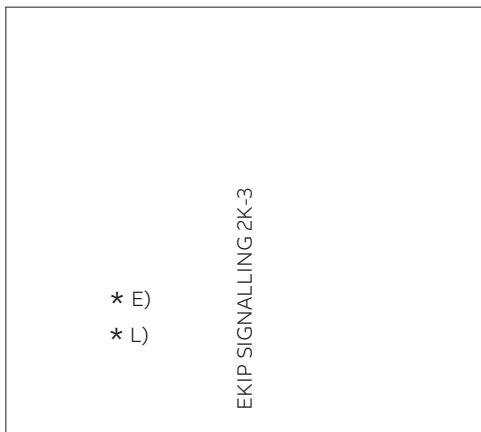
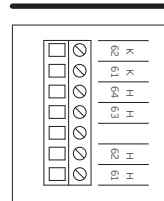
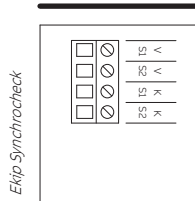
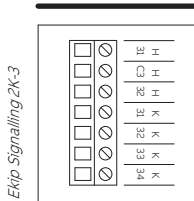
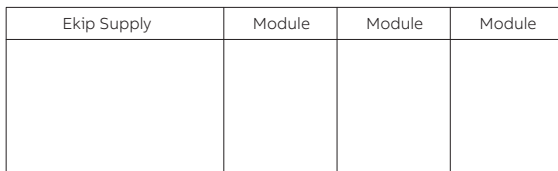

V4

81

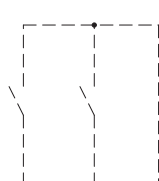

V5

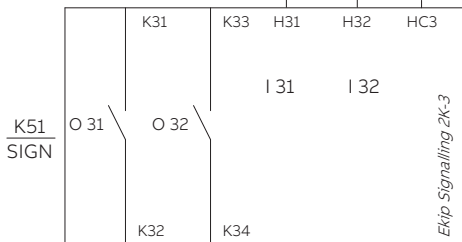

V4

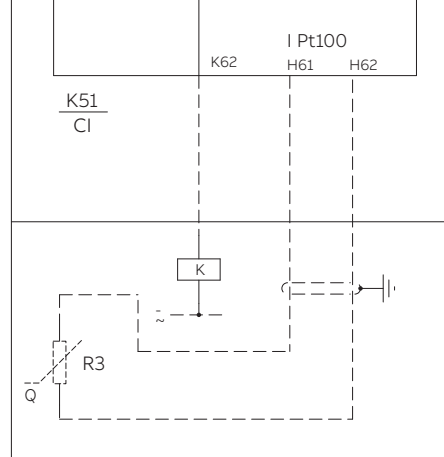
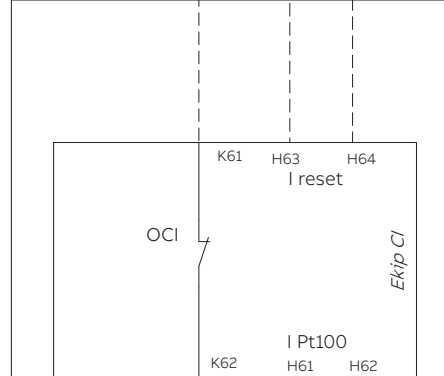
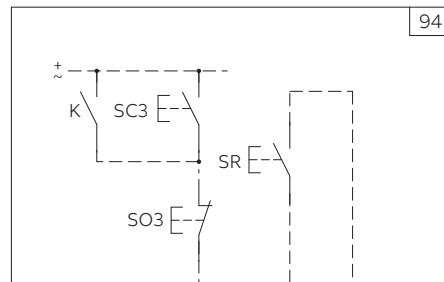
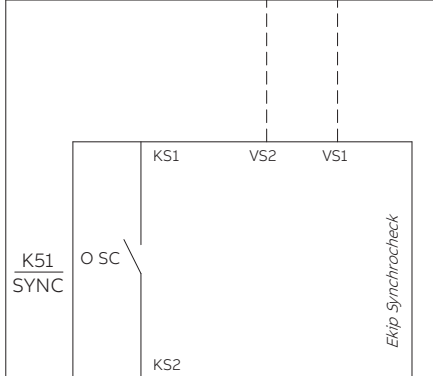
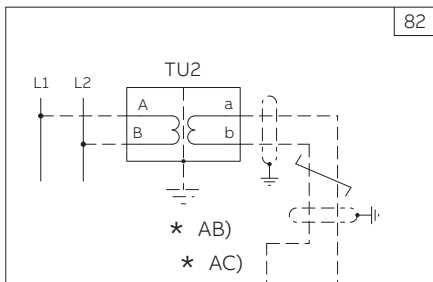

Ekip DIN Rail Cartridge Basic

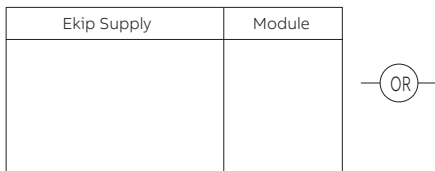

Ekip DIN Rail Cartridge

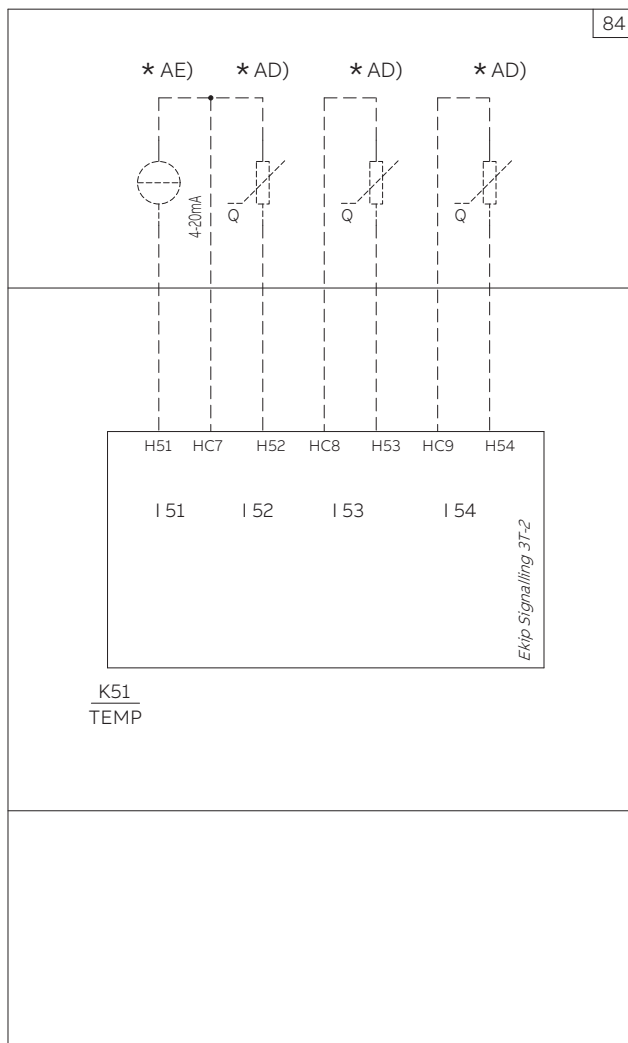
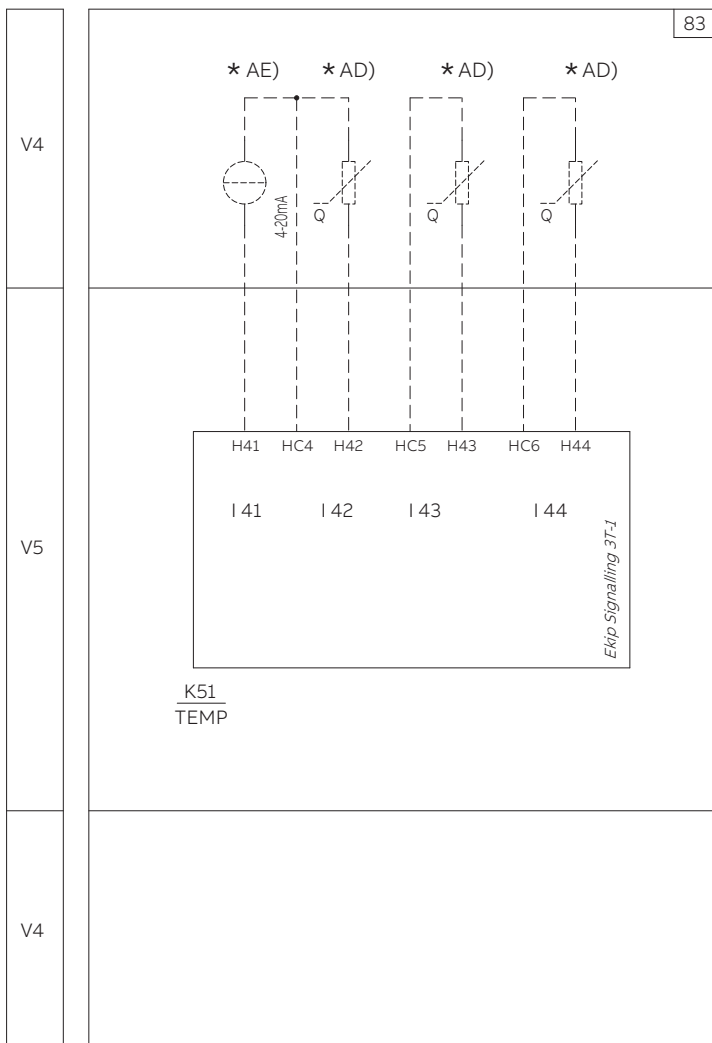
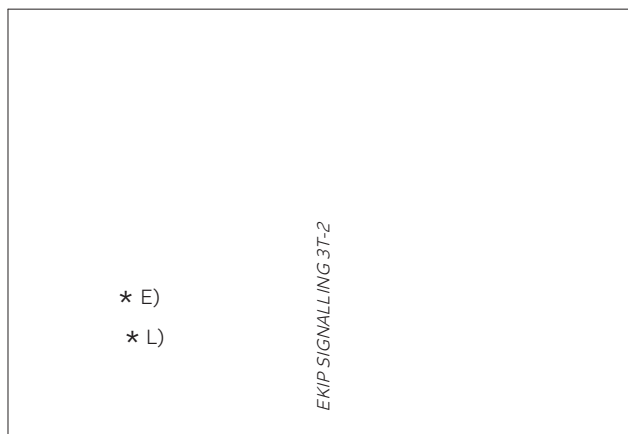
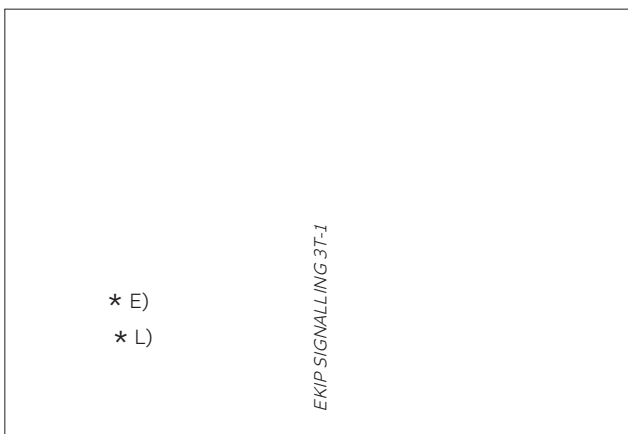
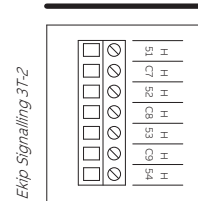
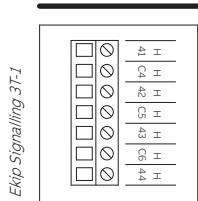
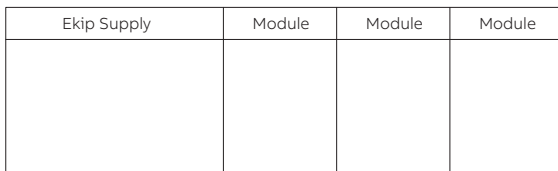

Ekip DIN Rail Cartridge Basic

Ekip DIN Rail Cartridge

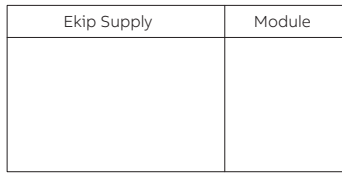

OR

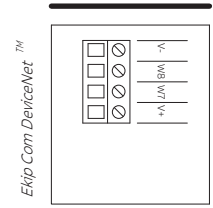
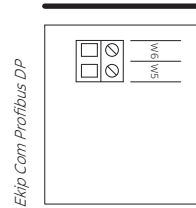
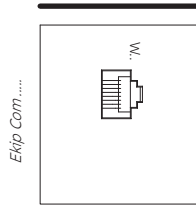
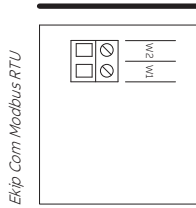
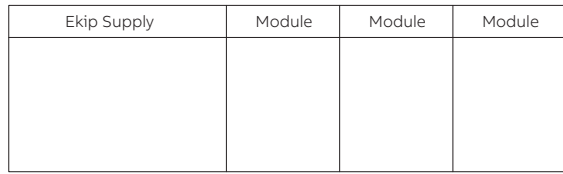

* E)
* L)

EKIP COM MODBUS RTU

* E)
* L)

EKIP COM
(VEDERE TABELLA SOTTO)
EKIP COM
(SEE TABLE BELOW)

* E)
* L)

EKIP COM PROFIBUS DP

* E)
* L)

EKIP COM DEVICENET™

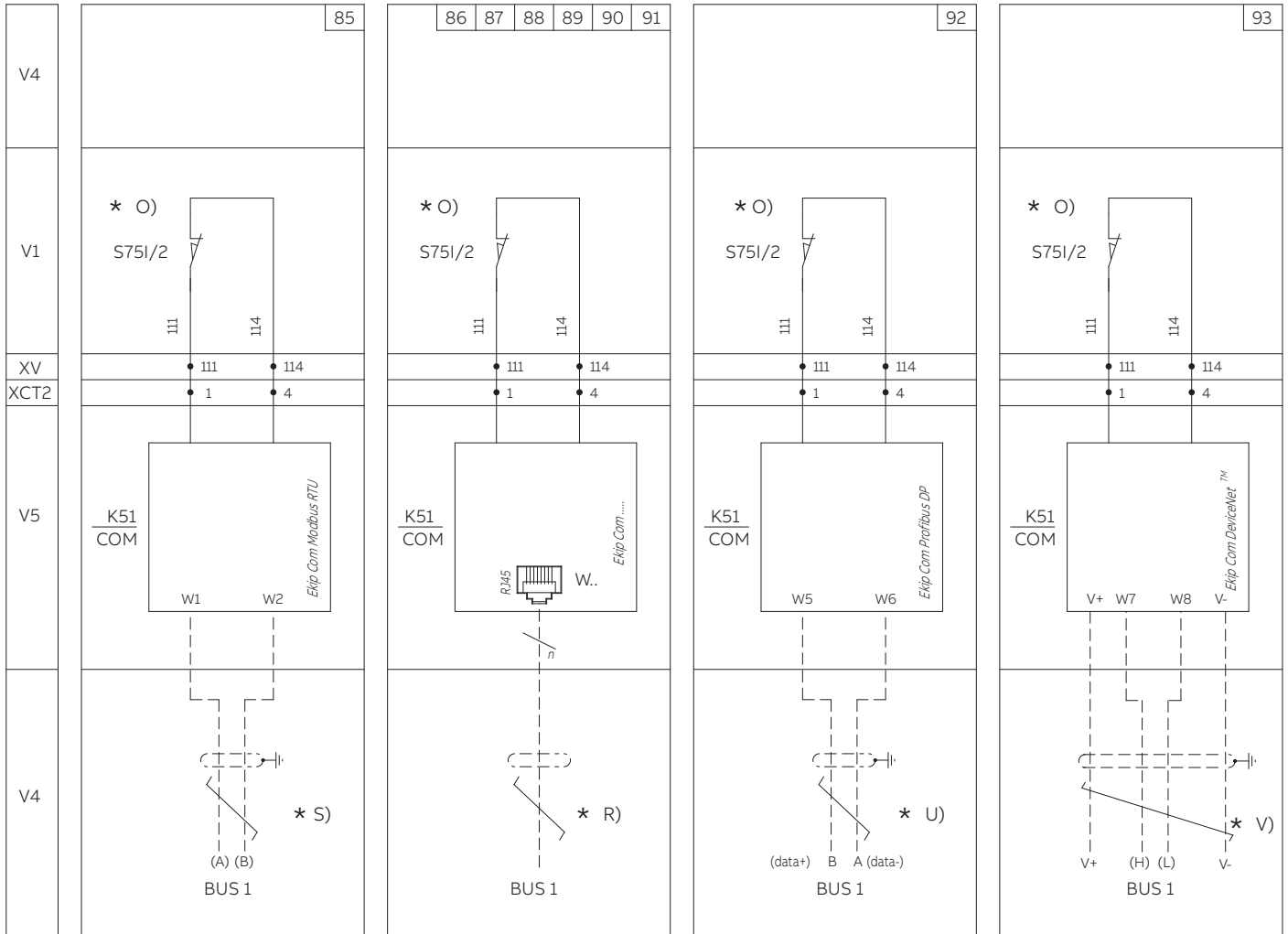

FIG.	DESCRIZIONE / DESCRIPTION	BUS1
86	EKIP COM MODBUS TCP	W9
87	EKIP COM PROFINET	W10
88	EKIP COM ETHERNET I/P™	W11
89	EKIP COM IEC61850	W12
90	EKIP COM LINK	W13
91	EKIP COM HUB	W14

Ekip DIN Rail Cartridge

Ekip Supply	Module	Module	Module

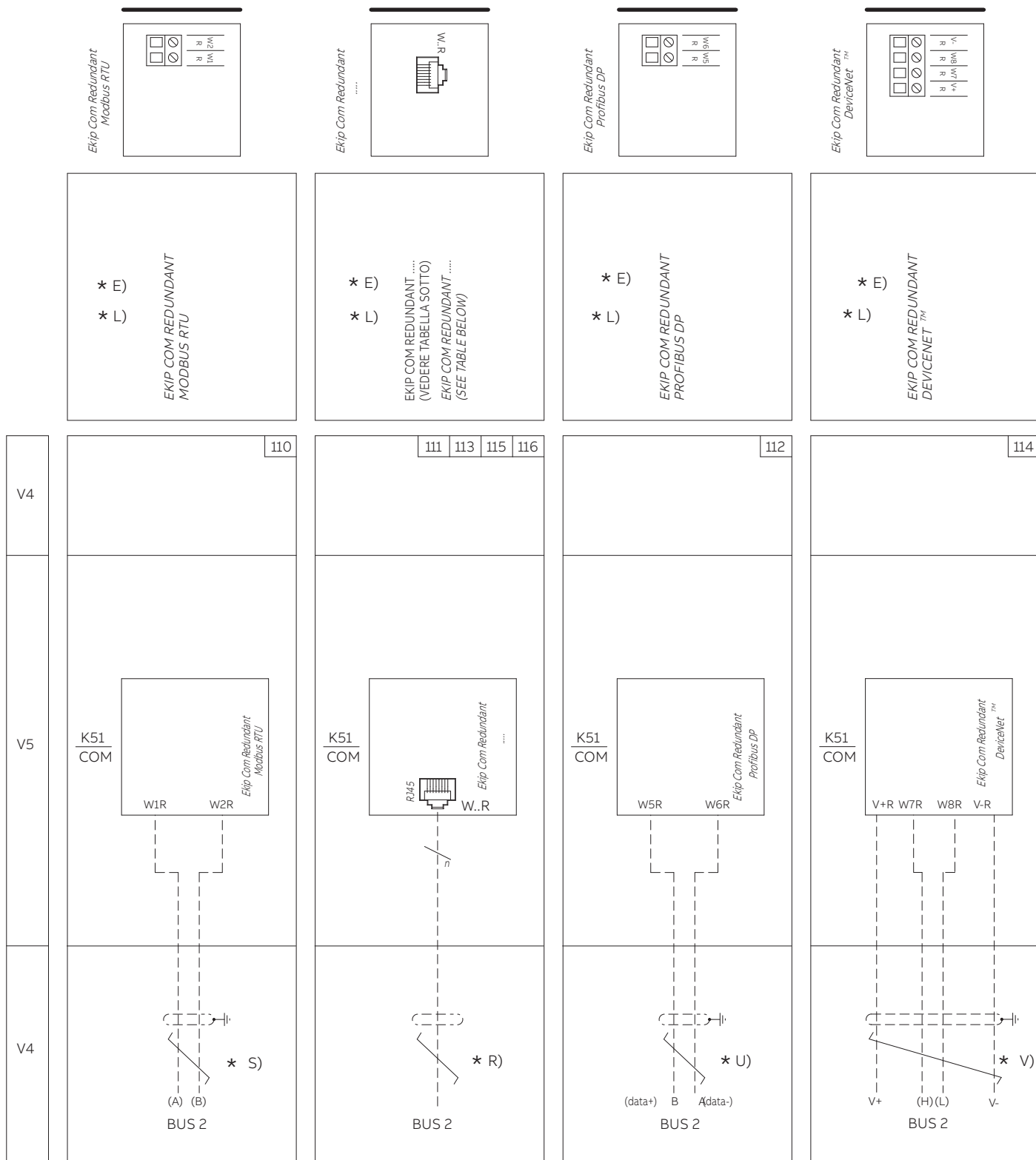
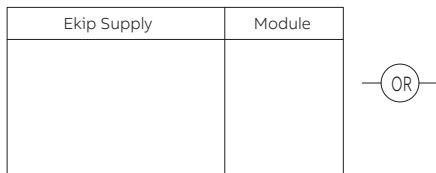
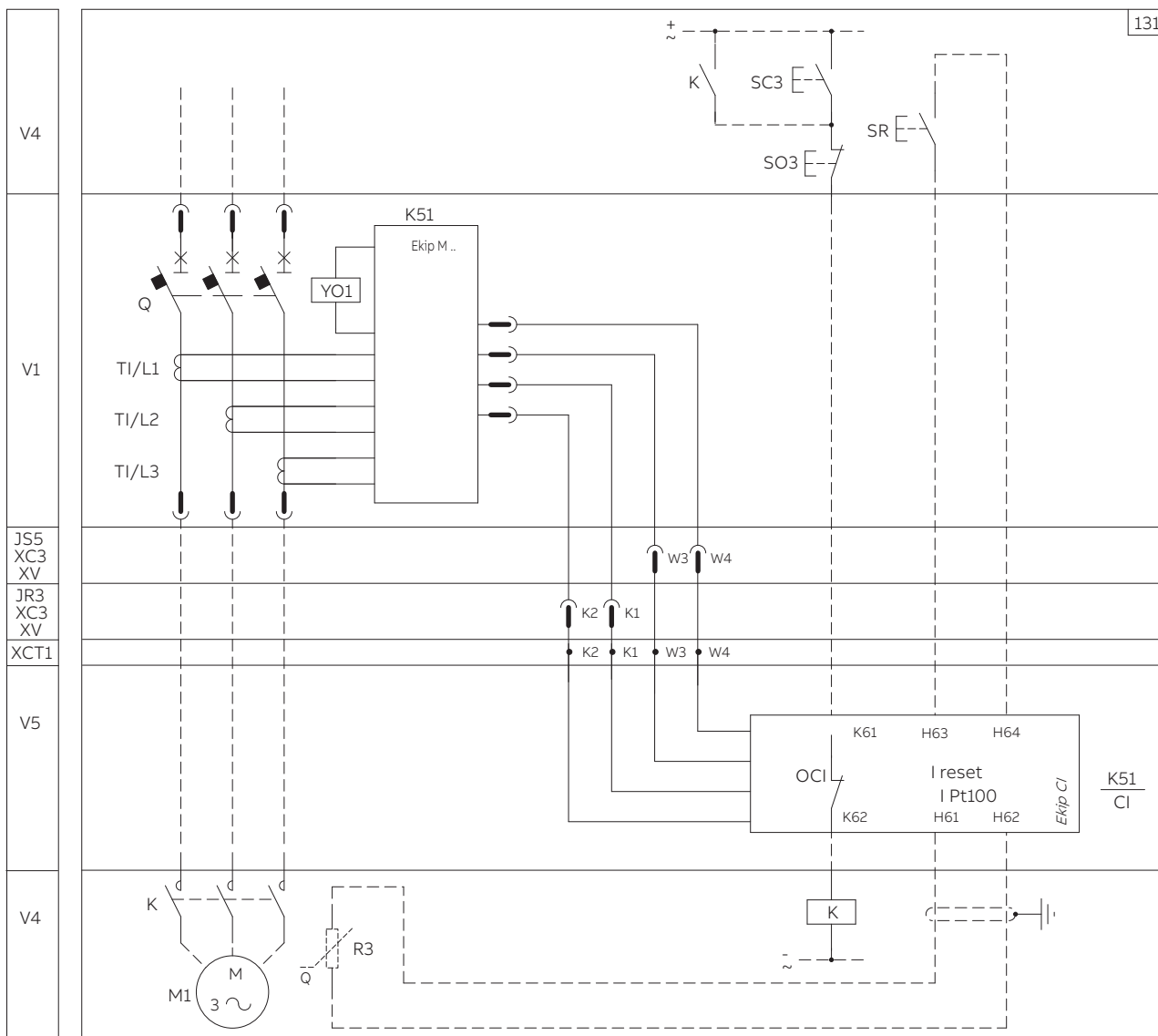
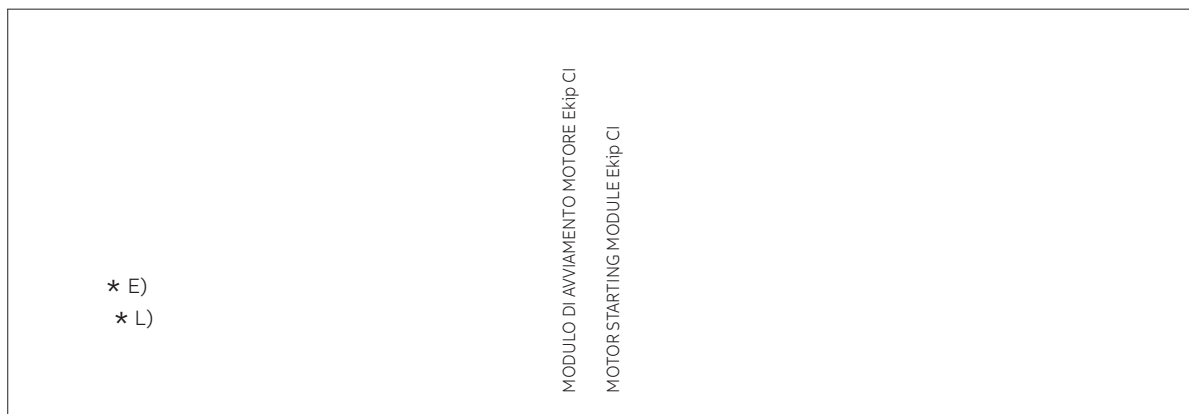
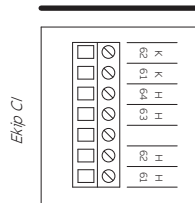
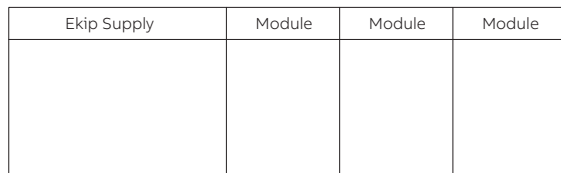

FIG.	DESCRIZIONE / DESCRIPTION	BUS2
111	EKIP COM REDUNDANT MODBUS TCP	W9R
113	EKIP COM REDUNDANT PROFINET	W10R
115	EKIP COM REDUNDANT ETHERNET I/P TM	W11R
116	EKIP COM REDUNDANT IEC61850	W12R

Ekip DIN Rail Cartridge Basic



Ekip DIN Rail Cartridge



Ekip DIN Rail Cartridge Basic

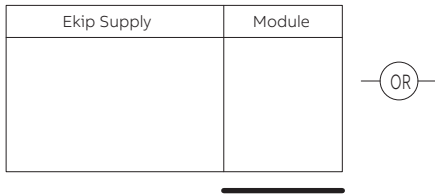

Ekip DIN Rail Cartridge

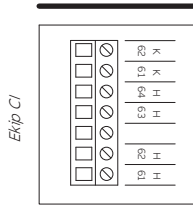
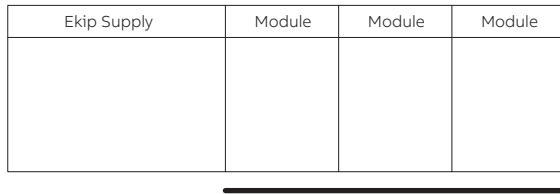

* E)
* L)

MODULO DI AVVIAMENTO MOTORE Ekip CI
CON CONTATTORE ABB SERIE AF
MOTOR STARTING MODULE Ekip CI
WITH ABB CONTACTOR SERIES AF

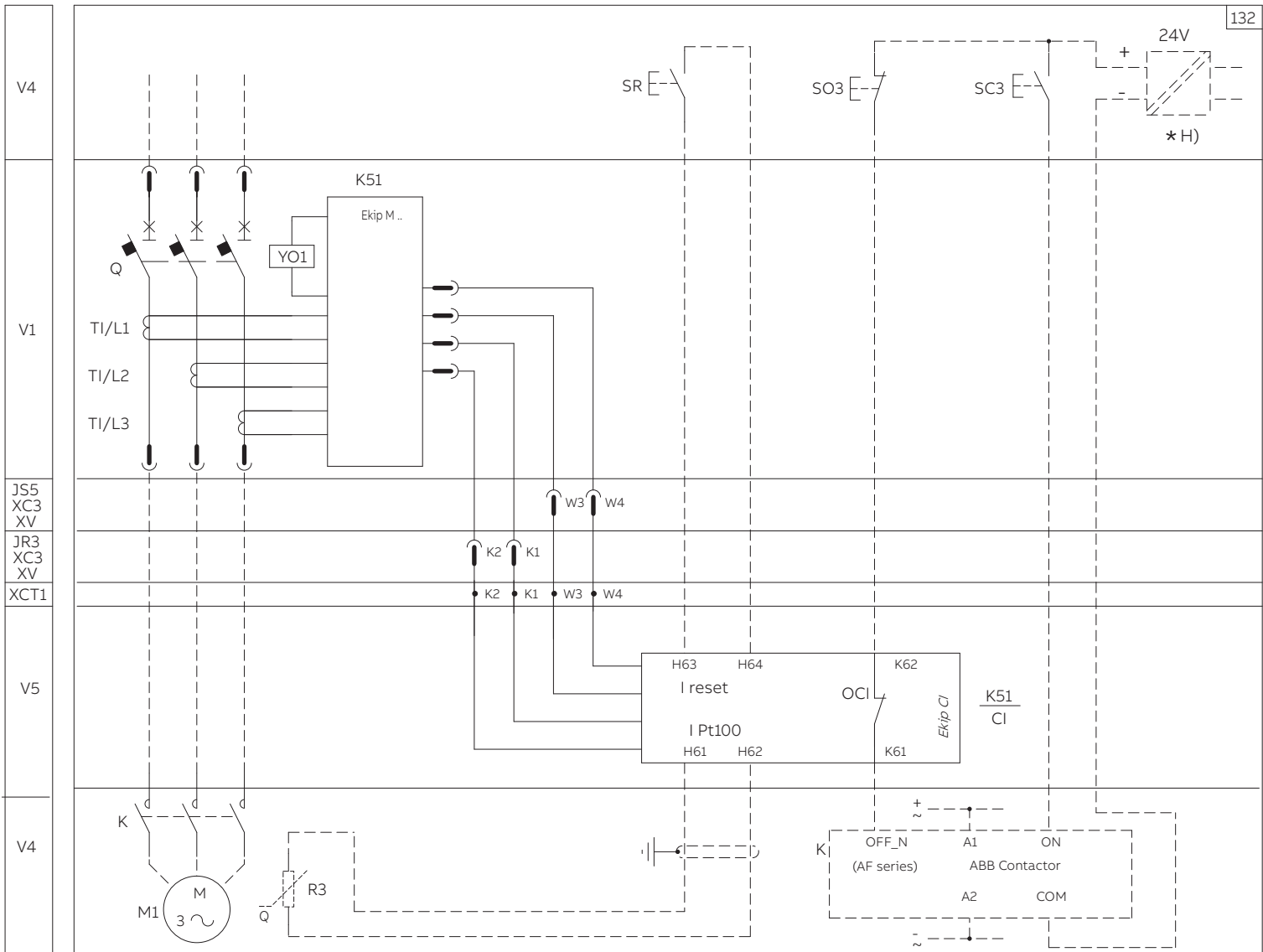

* E)

UNITA' DI SEGNALAZIONE TIPO Ekip Signalling 10K
Ekip Signalling 10K SIGNALLING UNIT

141

V4

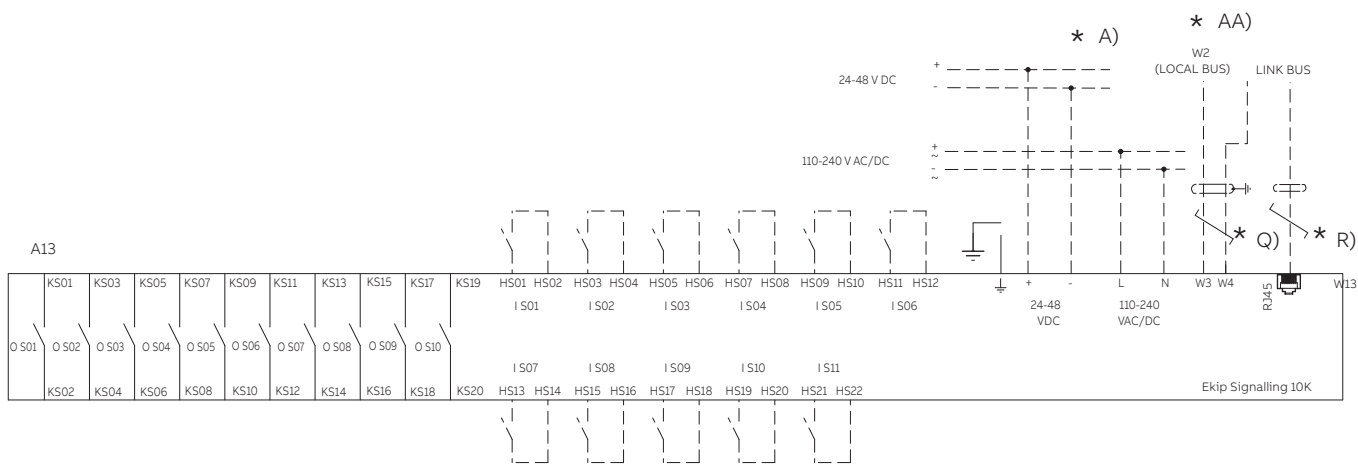

* E)

UNITA' MISURE TIPO Ekip Multimeter CON RELE' CON
 ALIMENTAZIONE AUSILIARIA DIRETTA 24VDC
 Ekip Metering METERING UNIT WITH RELAY WITH
 DIRECT AUXILIARY SUPPLY 24VDC

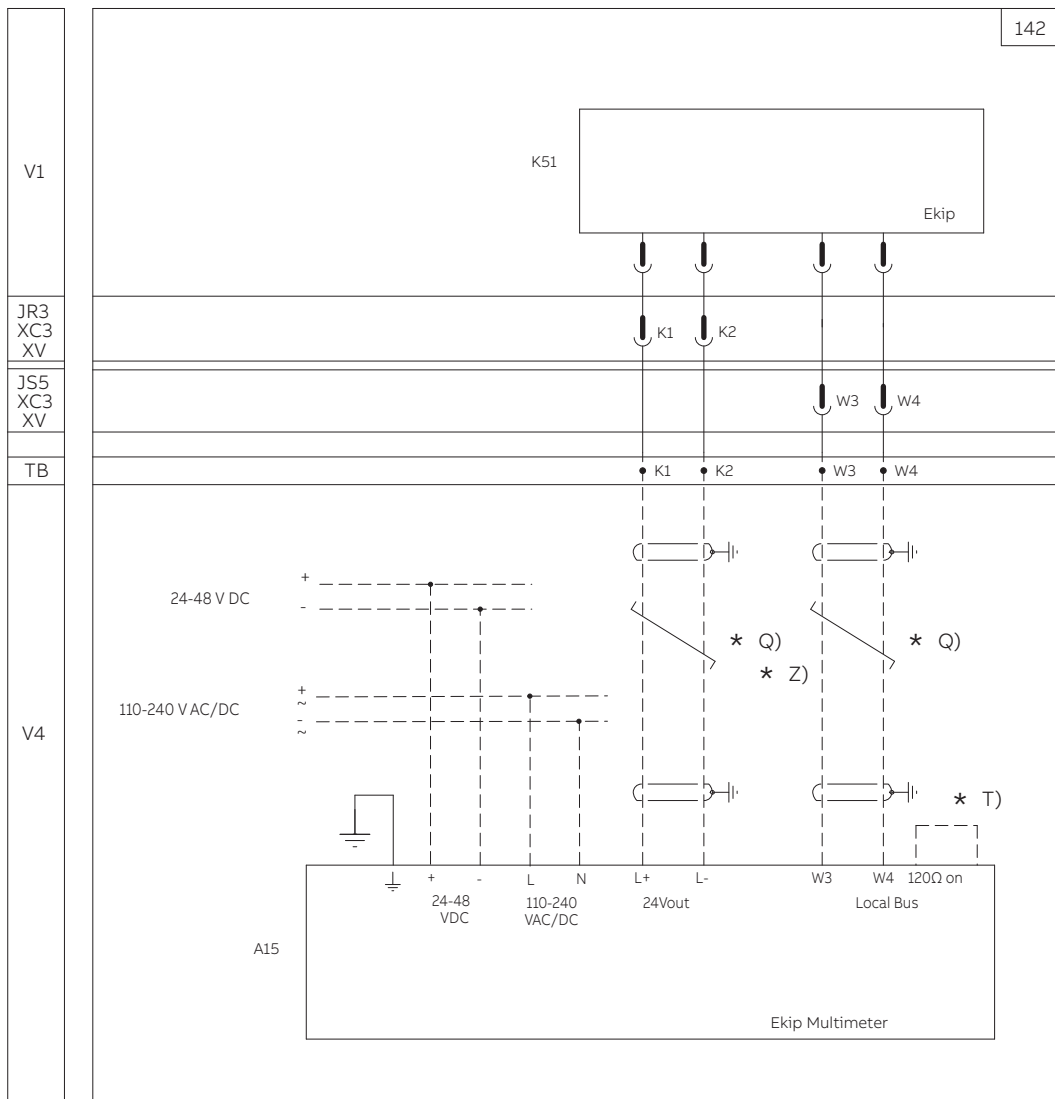

* E)

UNITA MISURE TIPO Ekip Multimeter CON RELE' CON ALIM. AUSILIARIA TRAMITE MODULO I10-240VAC/DC O 24-48VDC
 Ekip Metering UNIT WITH RELEY WITH AUXILIARY SUPPLY THROUGH MODULE I10-240VAC/DC OR 24-48VDC

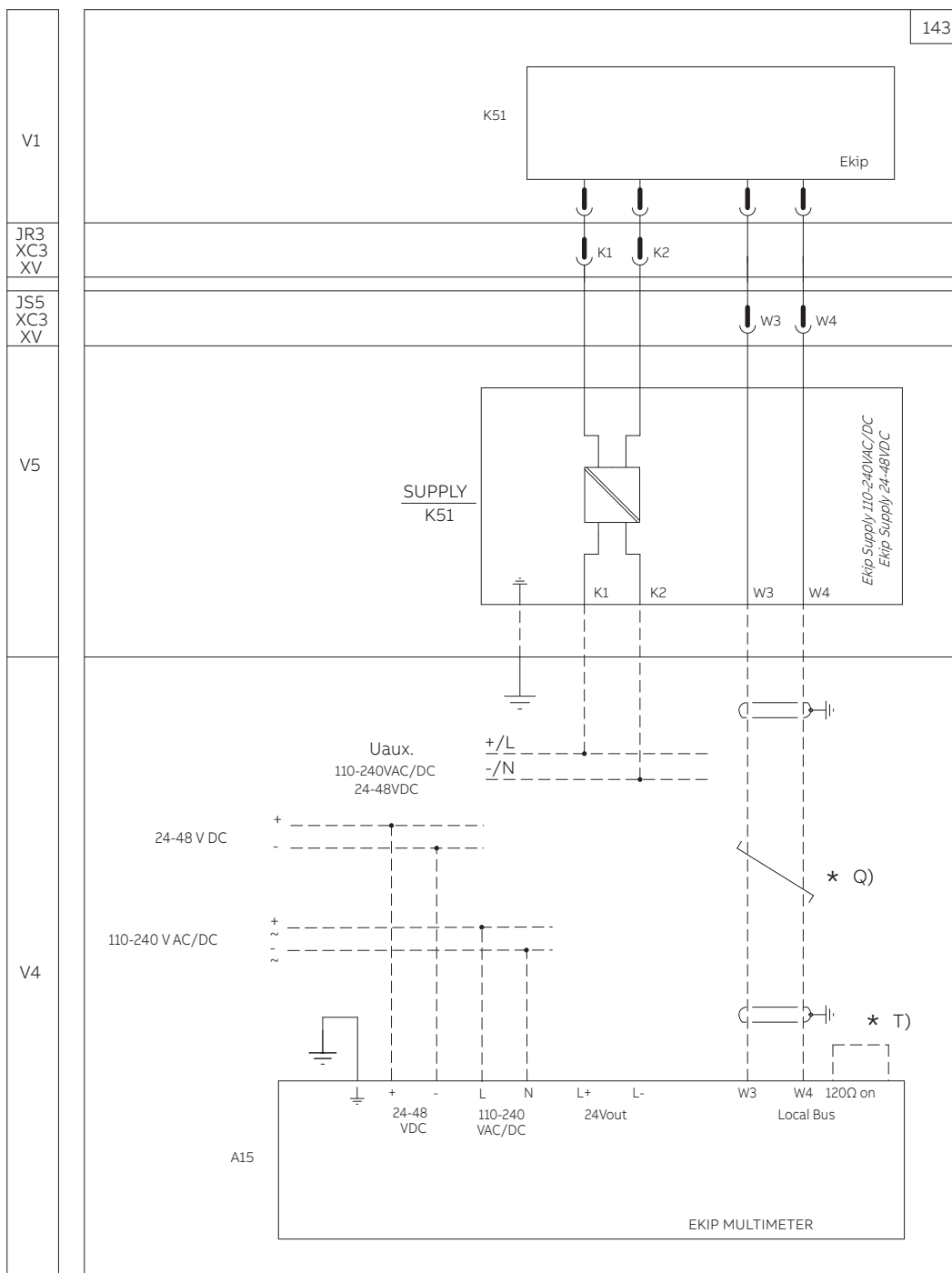











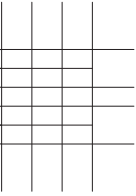
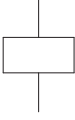

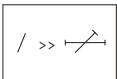

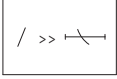

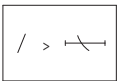

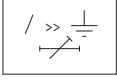

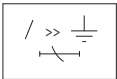
143

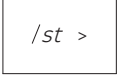
SEGNI GRAFICI PER SCHEMI ELETTRICI (NORME IEC 617 E CEI 3-14...3-26)
 GRAPHICAL SYMBOLS FOR ELECTRICAL DIAGRAMS (617 IEC STANDARDS)

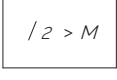
SEGNO SYMBOL	IEC 617	LEGENDA DESCRIPTION	SEGNO SYMBOL	IEC 617	LEGENDA DESCRIPTION
	02-08-01	-EFFETTO TERMICO -THERMAL EFFECT		02-17-06 + 02-17-07	-CONVERTITORE SEPARATO GALVANICAMENTE -CONVERTER WITH GALVANIC SEPARATOR
	02-08-02	-EFFETTO ELETTROMAGNETICO -ELECTROMAGNETIC EFFECT		02-17-06 + 02-02-04	-ADATTATORE/CONVERTITORE DI TENSIONE -VOLTAGE ADAPTER / CONVERTER
	02-12-01	-SCHERMO (PUO' ESSERE DISEGNATO CON QUALSIASI FORMA) -SCREEN, SHIELD (IT MAY BE DRAWN IN ANY CONVENIENT SHAPE)		03-01-03	-TRE CONDUTTORI -THREE CONNECTIONS
	02-08-05	-TEMPORIZZAZIONE -DELAY		03-01-07 + 03-01-09	-CONDUTTORI IN CAVO SCHERMATO (ESEMPIO: TRE CONDUTTORI) -CONDUCTORS IN A SCREENED CABLE, THREE CONDUCTORS SHOWN
	02-12-01	-COLLEGAMENTO MECCANICO -MECHANICAL CONNECTION (LINK)		03-01-08	-CONDUTTORI O CAVI CORDATI (ES.: TRE CONDUTTORI) -TWISTED CONDUCTORS, THREE CONDUCTORS SHOWN
	02-13-01	-COMANDO MECCANICO MANUALE (CASO GENERALE) -MANUALLY OPERATED CONTROL (GENERAL CASE)		03-02-01	-CONNESSIONE DI CONDUTTORI -CONNECTION OF CONDUCTORS
	02-13-04	-COMANDO ROTATIVO -OPERATED BY TURNING		03-02-02	-TERMINALE O MORSETTO -TERMINAL
	02-13-05	-COMANDO A PULSANTE -OPERATED BY PUSHING		03-03-05	-PRESA E SPINA (FEMMINA E MASCHIO) -PLUG AND SOCKET (MALE AND FEMALE)
	02-13-13	-COMANDO A CHIAVE -OPERATED BY KEY		04-01-01 + 02-03-04	-RESISTORE VARIABILE, DIPENDENTE DALLA TEMPERATURA -VARIABLE RESISTOR, DEPENDING FROM TEMPERATURE
	02-13-16	-COMANDO A CAMMA -OPERATED BY CAM		06-04-01	-MOTORE (SEGNO GENERALE) -MOTOR (GENERAL SYMBOL)
	02-15-01	-TERRA (SEGNO GENERALE) -EARTH (GENERAL SYMBOL)		06-08-01	-MOTORE ASINCRONO TRIFASE, CON ROTORE IN CORTO CIRCUITO (A GABBIA) -INDUCTION MOTOR, THREE-PHASE, SQUIRREL CAGE
	02-16-01	-GENERATORE IDEALE DI CORRENTE -IDEAL CURRENT SOURCE		06-09-11	-TRASFORMATORE DI CORRENTE -CURRENT TRANSFORMER

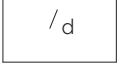
SEGNI GRAFICI PER SCHEMI ELETTRICI (NORME IEC 617 E CEI 3-14...3-26)
 GRAPHICAL SYMBOLS FOR ELECTRICAL DIAGRAMS (617 IEC STANDARDS)

SEGNO SYMBOL	IEC 617	LEGENDA DESCRIPTION	SEGNO SYMBOL	IEC 617	LEGENDA DESCRIPTION
	06-13-01	-TRASFORMATORE DI TENSIONE -VOLTAGE TRANSFORMER		07-13-08	-INTERRUPTORE DI MANOVRA-SEZIONATORE -SWITCH-DISCONNECTOR (ON-LOAD ISOLATING SWITCH)
	06-13-11 + 06-13-07	-TRASFORMATORE DI CORRENTE CON PRIMARIO COSTITUITO DA 4 CONDUTTORI PASSANTI E CON SECONDARIO AVVOLTO, CON PRESA -CURRENT TRANSFORMER WITH FOUR THREADED WINDINGS AND WITH ONE PERMANENT WINDING WITH ONE TAPPING		07-15-01	-BOBINA DI COMANDO (SEGNO GENERALE) -OPERATING DEVICE (GENERAL SYMBOL)
				(07-16-01)	-RELÉ DI MASSIMA CORRENTE Istantaneo -INSTANTANEOUS OVERCURRENT OR RATE-OF-RISE RELAY
	07-02-01	-CONTATTO DI CHIUSURA -MAKE CONTACT		(07-16-01)	-RELÉ DI MASSIMA CORRENTE CON CARATTERISTICA DI RITARDO A TEMPO BREVE REGOLABILE -OVERCURRENT RELAY WITH ADJUSTABLE SHORT TIME-LAG CHARACTERISTIC
	07-02-03	-CONTATTO DI APERTURA -BREAK CONTACT		(07-16-01)	-RELÉ DI MASSIMA CORRENTE CON CARATTERISTICA DI RITARDO A TEMPO BREVE INVERSO -OVERCURRENT RELAY WITH INVERSE SHORT TIME-LAG CHARACTERISTIC
	07-02-04	-CONTATTO DI SCAMBIO CON INTERRUZIONE MOMENTANEA -CHANGE-OVER BREAK BEFORE MAKE CONTACT		(07-16-01)	-RELÉ DI MASSIMA CORRENTE CON CARATTERISTICA DI RITARDO A TEMPO LUNGO INVERSO -OVERCURRENT RELAY WITH INVERSE LONG TIME-LAG CHARACTERISTIC
	07-08-01	-CONTATTO DI POSIZIONE DI CHIUSURA (FINE CORSA) -POSITION SWITCH (LIMIT SWITCH), MAKE CONTACT		(07-16-01)	-RELÉ DI MASSIMA CORRENTE PER GUASTO A TERRA CON CARATTERISTICA DI RITARDO A TEMPO BREVE REGOLABILE -EARTH FAULT OVERCURRENT RELAY WITH ADJUSTABLE SHORT TIME-LAG CHARACTERISTIC
	07-08-02	-CONTATTO DI POSIZIONE DI APERTURA (FINE CORSA) -POSITION SWITCH (LIMIT SWITCH), BREAK CONTACT		(07-16-01)	-RELÉ DI MASSIMA CORRENTE PER GUASTO A TERRA CON CARATTERISTICA A TEMPO BREVE INVERSO -EARTH FAULT OVERCURRENT RELAY WITH INVERSE SHORT TIME-LAG CHARACTERISTIC
	.	-CONTATTO DI POSIZIONE DI SCAMBIO CON INTERRUZIONE MOMENTANEA (FINE CORSA) -POSITION SWITCH (LIMIT SWITCH) CHANGE-OVER BREAK BEFORE MAKE CONTACT		(07-16-01)	-RELÉ DI PROTEZIONE ROTORE BLOCCATO -ROTOR BLOCKAGE PROTECTION RELAY
	.	-CONTATTO DI CHIUSURA ANTICIPATO -EARLY MAKE CONTACT		(07-16-01)	-RELÉ DI PROTEZIONE PERDITA E/O SQUILIBRIO DI FASE PER MOTORE -MOTOR PHASE LOSS AND/OR UNBALANCE PROTECTION RELAY
	07-13-05+ 07-01-03+ 07-01-05	-INTERRUPTORE DI POTENZA-SEZIONATORE AD APERTURA AUTOMATICA -CIRCUIT BREAKER-DISCONNECTOR WITH AUTOMATIC RELEASE		(07-16-01)	-RELÉ DI PROTEZIONE DIFFERENZIALE DI CORRENTE -DIFFERENTIAL CURRENT PROTECTION RELAY
	07-13-02	-CONTATTORE (CONTATTO DI CHIUSURA) -CONTACTOR (CONTACT OPEN IN THE UNOPERATED POSITION)		08-10-01	-LAMPADA, SEGNO GENERALE -LAMP, GENERAL SYMBOL

STATO DI FUNZIONAMENTO RAPPRESENTATO

Lo schema è rappresentato nelle seguenti condizioni:

- interruttore in esecuzione estraibile o rimovibile aperto e inserito
- contattore per l'avviamento del motore aperto
- circuiti in assenza di tensione
- sganciatori non intervenuti

LEGENDA

* = Vedere la nota indicata dalla lettera

A12 = Unità di interfaccia tipo Ekip Com

A13 = Unità di segnalazione tipo Ekip Signalling 10K

A14 = Unità di attuazione tipo MOE-E per il comando a motore ad accumulo di energia

A15 = Unità misure tipo Ekip Multimeter

A16 = Unità di interfaccia tipo Ekip Micro Module I/O

A17 = Unità di attuazione tipo MOE per il comando a motore ad accumulo di energia

A18 = Ekip DIN Rail Cartridge Basic

A19 = Ekip DIN Rail Cartridge

A20 = Unità di attuazione tipo MOE AUTO-RESET per il comando a motore ad accumulo di energia

BUS1 = Interfaccia seriale con il bus esterno

BUS2 = Interfaccia seriale ridondante con il bus esterno

LINK BUS = Interfaccia con il Link bus esterno

D = Ritardatore elettronico della bobina di minima tensione YU, esterno all'interruttore (solo per tensioni fino a 250V)

E = Adattatore/Convertitore elettronico delle bobine YO e YU, esterno all'interruttore

H2 = Lampada di segnalazione per comando a motore ad accumulo di energia bloccato
Lampada accesa= Stato Manuale; Lampada spenta= Stato Automatico

I 01-11...32 = Ingressi digitali programmabili

I 41-51 = Ingressi analogici da sensore 4-20mA

I 42...44 52...54 = Ingressi analogici da sensore di temperatura

I Pt100 = Ingresso analogico da sensore di temperatura Pt100 del motore

I reset = Ingresso digitale per il reset dello sgancio dell'unità di comando contattore di avviamento motore

J... = Connettori per i circuiti ausiliari dell'interruttore in esecuzione estraibile, l'estrazione dei connettori avviene contemporaneamente a quella dell'interruttore

K = Contattore per l'avviamento del motore

K51 = Relè elettronico di protezione di massima corrente tipo Ekip

K51/CI = Modulo di comando contattore per l'avviamento del motore

K51/COM = Modulo comunicazione

K51/SIGN = Modulo di segnalazione

K51/SUPPLY = Modulo alimentazione ausiliaria (110-240VAC/DC e 24-48VDC)

K51/SYNC = Modulo sincronizzazione

K51/TEMP = Modulo di controllo temperatura

K87 = Relè differenziale

M = Motore per l'apertura dell'interruttore e la carica delle molle di chiusura

M1 = Motore asincrono trifase

O 01-11...32 = Contatti di segnalazione programmabili

OCI = Contatto per il comando del contattore di avviamento motore

O SC = Contatto per il controllo di sincronismo

Q = Interruttore principale

Q/0...7 = Contatti ausiliari aperto/chiuso dell'interruttore

Q/26 = Contatti ausiliari aperto/chiuso usati all'interno dello sganciatore di protezione

R3 = Sensore di temperatura Pt100 del motore

S1 = Contatto comandato dalla camma del comando a motore
 S3/1-2 = Contatti comandati dal selettore Auto/Manual a dal blocco a chiave del comando a motore
 S4/1-2 = Contatti ausiliari anticipati azionati dalla maniglia rotante dell'interruttore
 S51 = Contatto di segnalazione di interruttore aperto per intervento dello sganciatore di protezione di massima corrente termomagnetico o del relè elettronico
 S52 = Contatto di segnalazione intervento sganciatore di minima tensione
 S75E/1 = Contatto per la segnalazione di interruttore in posizione di estratto (previsto solo con interruttori in esecuzione estraibile)
 S75I/1-2-3 = Contatti per la segnalazione di interruttore in posizione di inserito (previsti solo con interruttori in esecuzione rimovibile o estraibile)
 S75T/1 = Contatto per la segnalazione di interruttore in posizione di test (previsto solo con interruttori in esecuzione estraibile)
 S87/1 = Contatto per la segnalazione elettrica di preallarme del relè differenziale
 S87/2 = Contatto per la segnalazione elettrica di allarme del relè differenziale
 S87/3 = Contatto per la segnalazione elettrica di interruttore aperto per intervento del relè differenziale
 SC = Pulsante o contatto per la chiusura dell'interruttore
 SC3 = Pulsante per l'avviamento del motore
 SD = Sezionatore dell'alimentazione del relè differenziale
 SO = Pulsante o contatto per l'apertura dell'interruttore
 SO3 = Pulsante per l'arresto del motore
 SR = Pulsante o contatto di reset elettrico
 SY/1...3 = Contatti di segnalazione di interruttore aperto per intervento del relè di protezione di massima corrente, dello sganciatore termomagnetico e delle bobine YO, YO1, YO2, YU (posizione di scattato)
 TI = Trasformatore di corrente toroidale
 TI/L1-L2-L3 = Trasformatore di corrente fase L1-L2-L3
 TI/N = Trasformatore di corrente sul neutro
 TU2 = Trasformatore di tensione di isolamento (esterno all'interruttore)
 Uaux = Tensione di alimentazione ausiliaria
 V1 = Applicazioni dell'interruttore
 V2 = Applicazioni del comando a motore
 V4 = Apparecchi e collegamenti indicativi per comando e segnalazione, esterni all'interruttore
 V5 = Applicazioni della cartuccia Ekip DIN Rail Cartridge Basic o Ekip DIN Rail Cartridge
 W2 = Interfaccia seriale con il bus interno (bus locale)
 W9...14 = Connettore RJ45 per unità di interfaccia e per moduli comunicazione
 W9R...12R = Connettore RJ45 per moduli comunicazione ridondanti
 X3-X4-X8 = Connettori del relè di protezione
 XB.. = Connettore a tre vie per i circuiti ausiliari dell'interruttore in esecuzione rimovibile
 XC.. = Connettore a sei vie per i circuiti ausiliari dell'interruttore in esecuzione rimovibile
 XC2-3 = Connettore a sei vie per i circuiti ausiliari dell'interruttore in esecuzione rimovibile per tensioni fino a 400V
 XCT1-2 = Morsettiere della cartuccia Ekip DIN Rail Cartridge Basic o Ekip DIN Rail Cartridge
 XD.. = Connettore a nove vie per i circuiti ausiliari dell'interruttore in esecuzione rimovibile
 XE.. = Connettore a quindici vie per i circuiti ausiliari dell'interruttore in esecuzione rimovibile
 XF.. = Connettore dell'unità di interfaccia tipo Ekip Com
 XH1 = Connettore del relè di protezione
 XV = Morsettiera delle applicazioni dell'interruttore
 YC = Bobina di chiusura del comando a motore
 YO = Bobina di apertura
 YO1 = Bobina di apertura per massima corrente
 YO2 = Bobina di apertura del relè differenziale
 YU = Bobina di minima tensione
 YU/O = Bobina di minima tensione e di apertura (Combo)

NOTE

- A. Per le funzioni di selettività di zona e di local bus è necessaria la presenza di alimentazione ausiliaria (vedere Fig. 41-78).
- B. La bobina di minima tensione viene fornita per alimentazione derivata a monte dell'interruttore o da una sorgente indipendente: è permessa la chiusura dell'interruttore solo a bobina eccitata (il blocco della chiusura è realizzato meccanicamente).
- C. I contatti S4/1 e S4/2 di Fig. 7-10-15 aprono il circuito ad interruttore aperto e lo richiudono quando viene realizzato un comando di chiusura manuale mediante maniglia rotante, in accordo alle Norme relative alle macchine utensili (la chiusura non avviene comunque se la bobina di minima tensione non è alimentata).
- D. = Solo per XT5 F-P.
- E. = Solo per XT5.
- G. Nel caso di interruttore tripolare in esecuzione fissa con trasformatore di corrente su conduttore neutro esterno all'interruttore, quando si vuole rimuovere l'interruttore è necessario cortocircuitare i morsetti del trasformatore TI/N.
- H. Essendo richiesta una Uaux isolata da terra è necessario utilizzare "convertitori galvanicamente separati" conformi alle norme IEC 60950 (UL 1950) o sue equivalenti.
- I. Obbligatorio in caso di presenza di qualsiasi modulo Ekip.
- L. In caso di cartucciera Ekip DIN Rail Cartridge Basic può essere fornita una sola applicazione tra le Fig. 79...93-131-132.
In caso di cartucciera Ekip DIN Rail Cartridge possono essere fornite fino a tre applicazioni tra le Fig. 79...93-131-132 prese una sola volta. E' possibile inoltre duplicare il modulo Ekip Com eventualmente selezionato scegliendo tra le Fig. 110...116.
- M. Per il corretto funzionamento deve essere sempre presente il modulo Ekip Supply più almeno un modulo.
- N. Devono essere usati cavi tipo BELDEN 3105A o equivalenti.
- O. In presenza di più moduli Ekip Com con interruttori in esecuzione estraibile, il contatto S75I/2 va collegato una volta sola su un solo modulo.
- P. La tensione ausiliaria Uaux. consente l'attivazione della totalità delle funzionalità dei relè di protezione elettronici EKIP. Essendo richiesta una Uaux isolata da terra è necessario utilizzare "convertitori galvanicamente separati" conformi alle norme IEC 60950 (UL 1950) o sue equivalenti.
- Q. Devono essere usati cavi tipo BELDEN 3105A o equivalente, con lunghezza massima di 15m.
- R. Cavo RJ45 suggerito: CAT6 STP.
- S. Per il collegamento della linea seriale EIA RS485 vedere il "Quaderno Applicazione Tecnica - vol. 9: La Comunicazione via BUS con gli interruttori ABB".
- T. Cortocircuitare i morsetti 120Ω on se si vuole inserire un resistenza di terminazione sul Local Bus.
- U. Usare cavi Belden tipo 3079A o equivalente. Per ulteriori dettagli vedere il White Paper 1SDC007412G0201 "Comunicazione con interruttore SACE Emax 2".
- V. Usare cavi Belden tipo 3084A o equivalente. Per ulteriori dettagli vedere il White Paper 1SDC007412G0201 "Comunicazione con interruttore SACE Emax 2".
- Z. Per alimentazione al relè elettronico tramite i morsetti K1 e K2 non è possibile utilizzare Ekip Supply.
- AA. Per la connessione di W3 e W4 vedere Fig. 78.
- AB. Utilizzare cavo bipolare e schermato tipo BELDEN 8762/8772 o equivalente. Lo schema va collegato a terra lato ingresso di selettività (per selettività di zona) o ambo i lati (per altre applicazioni).
- AC. La tensione secondaria nominale massima è di 120V.
- AD. Utilizzare cavi isolati per termocoppie tipo PENTRONIC TEC/SITW-24F (tipo TX) o equivalente, di lunghezza non superiore a 3m.
- AE. Utilizzare cavi adeguati e compatibili con l'ambiente di lavoro in cui il sensore di corrente 4-20mA è utilizzato, di lunghezza non superiore a 3m.
- AF. Il collegamento deve essere realizzato con il cavo fornito; il cavo non può essere interrotto e non è ammesso l'utilizzo di altri cavi né l'estensione per mezzo di morsettiere intermedie.

INTERRUTTORE XT6 TRIPOLARE E TETRAPOLARE IN ESECUZIONE FISSA

Possono essere fornite le applicazioni indicate nelle figure 1-2-5-6-7-8-9-10-11-12-15-18-20-21-23-24-39-40.

La seguente tabella indica incompatibilità tra le varie applicazioni (X= applicazioni incompatibili):

1												
2												
5	x											
8		x										
11	x		x									
12		x		x								
18												
20												
21							x					
23												
24							x		x			
	1	2	5	8	11	12	18	20	21	23	24	

INTERRUTTORE XT6 TRIPOLARE E TETRAPOLARE IN ESECUZIONE RIMOVIBILE

Possono essere fornite le applicazioni indicate nelle figure 1-2-5-6-7-8-9-10-11-12-15-18-20-21-23-24-39-40.

La seguente tabella indica incompatibilità tra le varie applicazioni (X= applicazioni incompatibili):

1												
2												
5	x											
8		x										
11	x		x									
12		x		x								
18												
20												
21							x					
23												
24							x		x			
	1	2	5	8	11	12	18	20	21	23	24	

INTERRUTTORE XT6 TRIPOLARE E TETRAPOLARE IN ESECUZIONE ESTRAIBILE

Possono essere fornite le applicazioni indicate nelle figure 1-2-5-6-7-8-9-10-11-12-15-18-20-21-23-24-28-29-40.

La seguente tabella indica incompatibilità tra le varie applicazioni (X= applicazioni incompatibili):

1												
2												
5	x											
8		x										
11	x		x									
12		x		x								
18												
20												
21							x					
23												
24							x		x			
	1	2	5	8	11	12	18	20	21	23	24	

OPERATING STATE SHOWN

The diagram illustrates the components in the following conditions:

- withdrawable or plug-in version of circuit-breaker, open and racked-in
- motor starting contactor open
- circuits de-energized
- releases not tripped

KEY

* = See note indicated by the letter

A12 = Ekip Com type interface unit

A13 = Ekip Signaling 10K type signaling unit

A14 = MOE-E type stored energy motor operator actuating unit

A15 = Ekip Multimeter type measurement unit

A16 = Ekip Micro Module I/O type interface unit

A17 = MOE type stored energy motor operator actuating unit

A18 = Ekip DIN Rail Cartridge Basic

A19 = Ekip DIN Rail Cartridge

A20 = MOE AUTO-RESET type stored energy motor operator actuating unit

BUS1 = Serial interface with external bus

BUS2 = Redundant serial interface with external bus

LINK BUS = Interface with external Link bus

D = Electronic time-delay device for undervoltage release coil YU, outside circuit-breaker
(only for voltage up to 250 V)

E = Adapter / Electronic converter for YO and YU coils outside circuit-breaker

H2 = Signaling lamp for stored energy motor operator blocked
Lamp on= Manual Status; Lamp off= Automatic Status

I 01-11...32 = Programmable digital inputs

I 41-51 = Analog inputs from 4-20mA sensor

I 42...44 52...54 = Analog inputs from temperature sensor

I Pt100 = Analog input from Pt100 temperature sensor of motor

I reset = Digital input for resetting tripped motor starting contactor operating unit

J... = Connectors for auxiliary circuits of withdrawable circuit-breaker. Withdrawal of connectors occurs at the same time as that of circuit-breaker

K = Motor starting contactor

K51 = Ekip type electronic relay for overcurrent protection

K51/CI = Motor starting contactor operator module

K51/COM = Communication module

K51/SIGN = Signaling module

K51/SUPPLY = Auxiliary supply module (110-240VAC/DC and 24-48VDC)

K51/SYNC = Synchronizing module

K51/TEMP = Temperature monitoring module

K87 = Residual current relay

M = Motor for opening circuit-breaker and loading closing springs

M1 = Three-phase asynchronous motor

O 01-11...32 = Programmable signaling contacts

O CI = Contact for motor starting contactor operating mechanism

O SC = Synchronism monitoring contact

Q = Main circuit-breaker

Q/0..7 = Auxiliary contacts of the circuit-breaker open/closed

Q/26 = Open/Close auxiliary contacts used internally by protection release

R3 = Pt100 temperature sensor of motor

S1 = Contact controlled by the motor operator cam
 S3/1-2 = Contacts controlled by Auto/Manual selector switch and key lock of motor operator
 S4/1-2 = Early auxiliary contacts operated by circuit-breaker mounted crank handle
 S51 = Contact for signaling circuit-breaker open due to tripped thermomagnetic overcurrent protection release or electronic relay
 S52 = signalling contact for minimum voltage relay tripping
 S75E/1 = Contact for signaling circuit-breaker in racked out position (only applicable to withdrawable circuit-breaker versions)
 S75I/1-2-3 = Contacts for signaling circuit-breaker in racked-in position (only applicable to withdrawable or plug-in circuit-breaker versions)
 S75T/1 = Contact for signaling circuit-breaker in test position (only applicable to withdrawable circuit-breaker versions)
 S87/1 = Contact for electrical signaling of residual current relay prealarm.
 S87/2 = Contact for electrical signaling of residual current relay alarm.
 S87/3 = Contact for electrical signaling of circuit-breaker open due to residual current relay trip.
 SC = Pushbutton or contact for closing the circuit-breaker
 SC3 = Motor start pushbutton
 SD = Residual current relay supply disconnecter
 SO = Pushbutton or contact for opening circuit-breaker
 SO3 = Motor stop pushbutton
 SR = Electrical reset pushbutton or contact
 SY/1...3 = Contacts for signaling circuit-breaker open due to tripped overcurrent protection relay, thermomagnetic release and coils YO, YO1, YO2, YU (tripped position)
 T1 = Toroidal current transformer
 T1/L1-L2-L3 = L1-L2-L3 phase current transformer
 T1/N = Current transformer on neutral
 TU2 = Insulation voltage transformer (outside circuit-breaker)
 Uaux = Auxiliary supply voltage
 V1 = Circuit-breaker applications
 V2 = Motor operator applications
 V4 = Indicative switchgear and connections for operation and signaling, outside circuit-breaker
 V5 = Ekip DIN Rail Cartridge Basic or Ekip DIN Rail Cartridge applications
 W2 = Serial interface with internal bus (local bus)
 W9...14 = Connector RJ45 for interface unit and for communication modules
 W9R...12R = Connector RJ45 for redundant communication modules
 X3-X4-X8 = Protection relay connectors
 XB.. = Three-way connector for auxiliary circuits of plug-in circuit-breaker
 XC.. = Six-way connector for auxiliary circuits of plug-in circuit-breaker
 XC2-3 = Six-way connector for auxiliary circuits of plug-in circuit-breaker for voltage up to 400V
 XCT1-2 = Terminal box of Ekip DIN Rail Cartridge Basic or Ekip DIN Rail Cartridge
 XD.. = Nine-way connector for auxiliary circuits of plug-in circuit-breaker
 XE.. = Fifteen-way connector for auxiliary circuits of plug-in circuit-breaker
 XF.. = Ekip Com type interface unit connector
 XH1 = Protection relay connector
 XV = Terminal box of circuit-breaker applications
 YC = Closing coil of stored energy motor operator
 YO = Opening coil
 YO1 = Coil for opening due to overcurrent
 YO2 = Opening coil of residual current relay
 YU = Undervoltage coil
 YU/O = Undervoltage and opening coil (Combo)

NOTES

- A. The presence of an auxiliary supply is required for the local bus and zone selectivity functions (see Fig. 41-78).
- B. The undervoltage coil is provided for power supply branched on the supply side of the circuit-breaker or from an independent source: circuit-breaker can only close when coil is energized (closing lock is obtained mechanically).
- C. Contacts S4/1 and S4/2 of Fig. 7-10-15 open circuit when circuit-breaker is open and close it again when a manual closing command is imparted by means of the rotary handle, in accordance with the Standards governing machine tools (however, circuit-breaker will not close if undervoltage release is not being supplied).
- D. = Only for XT5 F-P.
- E. = Only for XT5.
- G. If a three-pole fixed circuit-breaker with current transformer on the neutral conductor outside the circuit-breaker is used, the terminals of the T1/N transformer must be short-circuited when the circuit-breaker must be removed.
- H. "Galvanically separated converters" conforming to standards IEC 60950 (UL 1950) or equivalent must be used since an earthed Uaux is required.
- I. Mandatory in the presence of any sort of Ekip module.
- L. Only one application among Fig. 79...93-131-132 can be supplied in the case of Ekip DIN Rail Cartridge Basic.
In the case of Ekip DIN Rail Cartridge, up to three applications can be supplied among Fig. 79...93-131-132, taken once only. In addition, the Ekip Com module (if chosen) can be duplicated by choosing among Fig. 110...116.
- M. To ensure correct operation, the Ekip Supply module and at least one module must always be present.
- N. BELDEN 3105A cables or an equivalent type must be used.
- O. When there are several Ekip Com modules with withdrawable circuit-breakers, contact S75I/2 must be connected once only to one single module.
- P. Auxiliary voltage Uaux allows all the functions of EKIP electronic protection relays to be activated. "Galvanically separated converters" conforming to standards IEC 60950 (UL 1950) or equivalent must be used since an earthed Uaux is required.
- Q. BELDEN 3105A cables or an equivalent type must be used. Maximum length 15 m.
- R. Recommended RJ45 cable: CAT6 STP.
- S. Consult "Technical Application Papers - vol. 9: Communication via BUS with ABB circuit-breakers" for connection of the EIA RS485 serial line.
- T. Short-circuit terminals 120Ω on to install a termination resistor on the Local Bus.
- U. Use Belden 3079A cables or equivalent. Consult White Paper 1SDC007412G0201 "Communication with SACE Emax 2 circuit-breakers" for further details.
- V. Use Belden 3084A cables or equivalent. Consult White Paper 1SDC007412G0201 "Communication with SACE Emax 2 circuit-breakers" for further details.
- Z. Ekip Supply cannot be used to energize the electronic relay via terminals K1 and K2.
- AA. Consult Fig. 78 for the connection of W3 and W4.
- AB. Use two-pole shielded cable type BELDEN 8762/8772 or equivalent. The shield must be earthed on the selectivity input side (for zone selectivity) or on both sides (for other applications).
- AC. The rated maximum secondary voltage is 120V.
- AD. Use insulated cables for thermocouples such as PENTRONIC TEC/SITW-24F (Type TX) or equivalent. Maximum length 3 m.
- AE. Use suitable cables up to 3 meters in length compatible with the workplace in which the 4-20mA current sensor is used
- AF. Make the connection using the cable provided. There must be no break in the cable. Use of other cables or extensions using intermediate terminal boxes is not allowed. With a circuit-breaker, the poles of the protection relay are short-circuited if the external neutral is not present: apply short-circuit if connection is absent.
- AG. Relay type TMG for XT5 only
- AH. Designation Connector X .. -> X3 for XT5; X4 for XT6

THREE-POLE WITHDRAWABLE CIRCUIT-BREAKER XT5

The applications shown in the following figures can be supplied: 1-2-5-6-7-8-9-10-11-12-15-18-19-20-21-22-23-24-25-28-29-30-31-32-39-40-42-43-44-45-46-50-61-62-63-64-65-66-67-68-69-71-72.

The incompatible elements among the various different applications (X = incompatible applications) are given in the table below:

1	2	5	8	11	12	7,10,15	18	19*	20	21	22	23	24	25*	42**	43	46	61**	62**	40	44-45-46
1																					
2																					
5	x																				
8																					
11	x		x																		
12		x		x																	
7,10,15																					
18																					
19*																					
20																					
21										x											
22		x		x		x															
23																					
24										x			x								
25*	x		x		x					x											
42**																					
43															x						
46																	X				
61**	x		x		x																
62**	x		x		x																
40											X										
44-45-46									X												

* with base Ekip relay only

** with Ekip Touch and Ekip Hi-Touch relay only

FOUR-POLE FIXED CIRCUIT-BREAKER XT5

The applications shown in the following figures can be supplied: figure 1-2-5-6-7-8-9-10-11-12-15-18-19-20-21-22-23-24-25-35-36-37-39-40-42-43-44-45-46-50-61-62-63-64-65-66-67-68-69-71-72.

The incompatible elements among the various different applications (X = incompatible applications) are given in the table below:

1	2	5	8	11	12	7,10,15	18	19*	20	21	22	23	24	25*	42**	43	46	61**	62**	40	44-45-46
1																					
2																					
5	x																				
8																					
11	x		x																		
12		x		x																	
7,10,15																					
18																					
19*																					
20																					
21										x											
22		x		x		x															
23																					
24										x			x								
25*	x		x		x					x											
42**																					
43															x						
46																	X				
61**	x		x		x																
62**	x		x		x																
40											X										
44-45-46									X												

* with base Ekip relay only

** with Ekip Touch and Ekip Hi-Touch relay only

THREE AND FOUR-POLE FIXED CIRCUIT-BREAKER XT6

The applications shown in the following figures can be supplied: figure 1-2-5-6-7-8-9-10-11-12-15-18-20-21-23-24-39-40.

The incompatible elements among the various different applications (X = incompatible applications) are given in the table below:

1												
2												
5	x											
8		x										
11	x		x									
12			x		x							
18												
20												
21								x				
23												
24								x		x		
	1	2	5	8	11	12	18	20	21	23	24	

THREE AND FOUR-POLE PLUG IN CIRCUIT-BREAKER XT6

The applications shown in the following figures can be supplied: figure 1-2-5-6-7-8-9-10-11-12-15-18-20-21-23-24-39-40.

The incompatible elements among the various different applications (X = incompatible applications) are given in the table below:

1												
2												
5	x											
8		x										
11	x		x									
12			x		x							
18												
20												
21								x				
23												
24								x		x		
	1	2	5	8	11	12	18	20	21	23	24	

THREE AND FOUR-POLE WITHDRAWABLE CIRCUIT-BREAKER XT6

The applications shown in the following figures can be supplied: 1-2-5-6-7-8-9-10-11-12-15-18-20-21-23-24-28-29-40.

The incompatible elements among the various different applications (X = incompatible applications) are given in the table below:

1												
2												
5	x											
8		x										
11	x		x									
12			x		x							
18												
20												
21								x				
23												
24								x		x		
	1	2	5	8	11	12	18	20	21	23	24	

DARGESTELLTER BETRIEBSZUSTAND

Das Schaltbild ist in den folgenden Betriebssituationen dargestellt:

- Leistungsschalter in der ausfahrbaren oder steckbaren Ausführung, ausgeschaltet und eingeschoben
- Schütz für den Motorstart, ausgeschaltet
- Stromkreise spannungsfrei
- Auslöser nicht ausgelöst

ZEICHENERKLÄRUNG

- * = Siehe den durch den Buchstaben gekennzeichneten Hinweis
- A12 = Schnittstelleneinheit Typ Ekip Com
- A13 = Meldeeinheit Typ Ekip Signalling 10K
- A14 = Aktuationseinheit Typ MOE-E für den Motorantrieb mit Federkraftspeicher
- A15 = Messeinheit Typ Ekip Multimeter
- A16 = Schnittstelleneinheit Typ Ekip Micro Module I/O
- A17 = Aktuationseinheit Typ MOE für den Motorantrieb mit Federkraftspeicher
- A18 = Ekip DIN Rail Cartridge Basic
- A19 = Ekip DIN Rail Cartridge
- A20 = Aktuationseinheit Typ MOE AUTO-RESET für den Motorantrieb mit Federkraftspeicher
- BUS1 = Serielle Schnittstelle zum externen Bus
- BUS2 = Redundante serielle Schnittstelle zum externen Bus
- LINK BUS = Schnittstelle mit den externen Link Bus
- D = Elektronische Verzögerungsvorrichtung der Unterspannungsspule YU, außerhalb des Leistungsschalters (nur für Spannungen bis zu 250 V)
- E = Adapter / Elektronischer Wandler für YO und YU, außerhalb des Leistungsschalters
- H2 = Meldelampe für den verriegelten Motorantrieb mit Federkraftspeicher
Lampe an = manueller Status; Lampe aus = Automatischer Status
- I 01-11...32 = Programmierbare digitale Eingänge
- I 41-51 = Analoge Eingänge vom Sensor 4-20mA
- I 42...44 52...54 = Analoge Eingänge vom Temperaturfühler
- I Pt100 = Analoger Eingang vom Temperaturfühler Pt100 des Motors
- I reset = Digitaler Eingang für das Reset der Auslösung der Steuereinheit des Schützes für den Motorstart
- J... = Steckverbinder für die Hilfsstromkreise des Leistungsschalters in ausfahrbarer Ausführung, das Ausfahren der Steckverbinder erfolgt gleichzeitig mit dem des Leistungsschalters
- K = Schütz für den Motorstart
- K51 = Elektronisches Überstromschutzrelais Typ Ekip
- K51/CI = Steuermodul des Schützes für den Motorstart
- K51/COM = Kommunikationsmodul
- K51/SIGN = Meldemodul
- K51/SUPPLY = Modul der Hilfsstromversorgung (110-240V AC/DC und 24-48V DC)
- K51/SYNC = Synchronisierungsmodul
- K51/TEMP = Temperatursteuermodul
- K87 = Fehlerstromrelais
- M = Motor zum Ausschalten des Leistungsschalters und das Spannen der Einschaltfedern
- M1 = Drehstrom-Asynchronmotor
- O 01-11...32 = Programmierbare Meldekontakte
- O CI = Kontakt für den Antrieb des Schützes für den Motorstart
- O SC = Kontakt für die Synchronüberwachung
- Q = Hauptschalter
- Q/0...7 = Hilfskontakte aus/ein des Leistungsschalters
- Q/26 = Hilfskontakte aus/ein, die innerhalb des Schutzauslösers benutzt werden

- R3 = Temperaturfühler Pt100 des Motors
- S1 = Kontakt, der vom Nocken des Motorantriebs gesteuert wird
- S3/1-2 = Kontakte, die durch den Wahlschalter Auto/Manual und durch die Schlüssellverriegelung des Motorantriebs gesteuert werden
- S4/1-2 = Voreilende Hilfskontakte, durch den Drehgriff des Leistungsschalters betätigt
- S51 = Kontakt zur Meldung Leistungsschalter ausgeschaltet wegen Auslösung des thermomagnetischen Überstromauslösers oder des elektronischen Relais
- S52 = Kontakt für die Ausgelöstmeldung YU/YO
- S75E/1 = Meldekontakt für Leistungsschalter in Außenstellung (nur mit Leistungsschaltern in ausfahrbarer Ausführung vorgesehen)
- S75I/1-2-3 = Meldekontakte für Leistungsschalter in Betriebsstellung (nur mit Leistungsschaltern in steckbaren oder ausfahrbarer Ausführung vorgesehen)
- S75T/1 = Meldekontakt für Leistungsschalter in Prüfstellung (nur mit Leistungsschaltern in ausfahrbarer Ausführung vorgesehen)
- S87/1 = Kontakt zur elektrischen Voralarmmeldung des Fehlerstromrelais
- S87/2 = Kontakt zur elektrischen Alarmmeldung des Fehlerstromrelais
- S87/3 = Kontakt zur elektrischen Meldung von Leistungsschalter wegen Auslösung des Fehlerstromrelais ausgeschaltet
- SC = Taste oder Kontakt zum Einschalten des Leistungsschalters
- SC3 = Taste zum Starten des Motors
- SD = Wahlschalter zur Speisung des Fehlerstromrelais
- SO = Taste oder Kontakt zum Ausschalten des Leistungsschalters
- SO3 = Taste zum Anhalten des Motors
- SR = Taste oder Kontakt zum elektrischen Reset
- SY/1...3 = Meldekontakte für Leistungsschalter ausgeschaltet wegen Ansprechen des Überstrom-Schutzrelais, des thermomagnetischen Auslösers und der Spulen YO, TO1, YO2, YU (Ausgelöst-Position)
- TI = Ringkernstromwandler
- TI/L1-L2-L3 = Stromwandler der Phasen L1-L2-L3
- TI/N = Stromwandler auf Neutralleiter
- TU2 = Isolationsspannungswandler (außerhalb des Leistungsschalters)
- Uaux = Hilfsspeisespannung
- V1 = Zubehöreinrichtungen des Leistungsschalters
- V2 = Zubehöreinrichtungen des Motorantriebs
- V4 = Geräte und Verbindungen zur Steuerung und Anzeige, außerhalb des Leistungsschalters
- V5 = Zubehöreinrichtungen des Steckmodulhalters Ekip DIN Rail Cartridge Basic oder Ekip DIN Rail Cartridge
- W2 = Serielle Schnittstelle mit internem Bus (Local Bus)
- W9...14 = Steckverbinder RJ45 für Schnittstelleneinheit und für Kommunikationsmodule
- W9R...12R = Steckverbinder RJ45 für redundante Kommunikationsmodule
- X3-X4-X8 = Steckverbinder des Schutzrelais
- XB.. = Dreipoliger Steckverbinder für die Hilfsstromkreise des Leistungsschalters in steckbarer Ausführung
- XC.. = Sechspoliger Steckverbinder für die Hilfsstromkreise des Leistungsschalters in steckbarer Ausführung
- XC2-3 = Sechspoliger Steckverbinder für die Hilfsstromkreise des Leistungsschalters in steckbarer Ausführung für Spannungen bis 400V
- XCT1-2 = Klemmenleisten des Steckmodulhalters Ekip DIN Rail Cartridge Basic oder Ekip DIN Rail Cartridge
- XD.. = Neunpoliger Steckverbinder für die Hilfsstromkreise des Leistungsschalters in steckbarer Ausführung
- XE.. = Fünfzehnpoliger Steckverbinder für die Hilfsstromkreise des Leistungsschalters in steckbarer Ausführung
- XF.. = Steckverbinder der Schnittstelleneinheit Typ Ekip Com
- XH1 = Steckverbinder des Schutzrelais

- XV = Klemmenleiste der Zubehöreinrichtungen des Leistungsschalters
- YC = Einschaltspule des Motorantriebs mit Federkraftspeicher
- YO = Ausschaltspule
- YO1 = Überstromausschaltspule
- YO2 = Ausschaltspule des Fehlerstromrelais
- YU = Unterspannungsspule
- YU/O = Unterspannungs- und Ausschaltspule (Combo)

ANMERKUNGEN

- A. Für die Funktionen der Zonenselektivität und des Local Bus ist das Vorhandensein der Hilfsstromversorgung erforderlich (siehe Abb. 41-78).
- B. Die Unterspannungsspule wird für die Stromversorgung geliefert, die stromaufwärts vom Leistungsschalter entnommen wird oder von einer unabhängigen Stromquelle stammt. Das Einschalten des Leistungsschalters ist nur dann zulässig, wenn die Spule erregt ist (die Einschaltverriegelung wird mechanisch betätigt).
- C. Die Kontakte S4/1 und S4/2 vom Abb. 7-10-15 öffnen den Stromkreis bei ausgeschaltetem Leistungsschalter und schließen ihn wieder gemäß der Normen für Werkzeugmaschinen bei manueller Einschaltung mit dem Drehhebel (die Einschaltung erfolgt jedoch nicht, wenn der Unterspannungsauslöser nicht gespeist ist).
- D. = Nur für XT5 F-P.
- E. = Nur für XT5.
- G. Im Fall des dreipoligen Leistungsschalters in fester Ausführung mit Stromwandler auf dem Neutralleiter außerhalb des Leistungsschalters muss man die Klemmen des Wandlers TI/N kurzschließen, wenn man den Leistungsschalter entfernen will.
- H. Da eine gegen Erde isolierte Hilfsspannung Vaux erforderlich ist, müssen "galvanisch getrennte Umformer" verwendet werden, die der Norm IEC 60950 (UL 1950) oder den gleichwertigen entsprechen.
- I. Zwingend vorgeschrieben, wenn irgendein Modul Ekip vorhanden ist.
- L. Im Fall des Steckmodulhalters Ekip DIN Rail Cartridge Basic kann nur eine Zubehöreinrichtung der Abb. 79...93-131-132 geliefert werden.
Im Fall des Steckmodulhalters Ekip DIN Rail Cartridge können bis zu drei Zubehöreinrichtungen der Abb. 79...93-131-132 geliefert werden, wenn man sie nur einmal wählt. Außerdem ist es möglich, das eventuell gewählte Modul Ekip Com zu verdoppeln, wenn man unter den Abb. 110...116 wählt.
- M. Für den korrekten Betrieb muss immer das Modul Ekip Supply plus mindestens ein Modul vorhanden sein.
- N. Es sind BELDEN Kabel vom Typ 3105A oder gleichwertigen Typs benutzen.
- O. Bei Vorhandensein von mehreren Modulen Ekip Com mit Leistungsschaltern in ausfahrbarer Ausführung wird der Kontakt S751/2 nur einmal auf einem einzigen Modul angeschlossen.
- P. Die Hilfsspannung Uaux erlaubt die Aktivierung der Gesamtheit der Funktionen der elektronischen Schutzrelais EKIP. Da eine gegen Erde isolierte Hilfsspannung Vaux erforderlich ist, müssen "galvanisch getrennte Umformer" verwendet werden, die der Norm IEC 60950 (UL 1950) oder den gleichwertigen entsprechen.
- Q. Es müssen Kabel vom Typ BELDEN 3150A oder gleichwertigen Typs mit maximaler Länge von 15m verwendet werden.
- R. Empfohlenes Kabel RJ45: CAT6 STP.
- S. Für den Anschluss der seriellen Leitung EIA RS485 siehe "Technisches Anwendungsheft - Band 9: Die Kommunikation über BUS mit den ABB Leistungsschaltern."
- T. Die Klemmen 120Ω ON kurzschließen, wenn man auf dem Local Bus einen Abschlusswiderstand einfügen will.
- U. Belden Kabel vom Typ 3079A oder gleichwertigen Typs benutzen. Für weitere Einzelheiten siehe das Weißbuch 1SDC007412G0201 "Kommunikation mit dem Leistungsschalter SACE Emax 2."

DREI- UND VIERPOLIGER LEISTUNGSSCHALTER XT6 IN AUSFAHRBARER AUSFÜHRUNG

Die in den Abbildungen dargestellten Zubehöreinrichtungen können geliefert werden 1-2-5-6-7-8-9-10-11-12-15-18-20-21-23-24-28-29-40.

Die folgende Tabelle gibt Inkompatibilitäten den verschiedenen Zubehöreinrichtungen an (X = inkompatible Zubehörteile):

1												
2												
5	x											
8		x										
11	x		x									
12		x		x								
18												
20												
21								x				
23												
24								x		x		
	1	2	5	8	11	12	18	20	21	23	24	

ETAT DE FONCTIONNEMENT REPRÉSENTÉ

Le schéma est représenté dans les conditions suivantes :

- disjoncteur en version déconnectable ou débrochable, ouvert et embroché
- contacteur de démarrage du moteur ouvert
- circuits hors tension
- déclencheurs non intervenus

LEGENDE

- * = Voir la remarque indiquée par la lettre
- A12 = Unité d'interface type Ekip Com
- A13 = Unité de signalisation type Ekip Signalling 10K
- A14 = Unité d'actionnement type MOE-E pour la commande à moteur à accumulation d'énergie
- A15 = Unité mesures type Ekip Multimeter
- A16 = Unité d'interface type Ekip Micro Module E/S
- A17 = Unité d'actionnement type MOE pour la commande à moteur à accumulation d'énergie
- A18 = Ekip DIN Rail Cartridge Basic
- A19 = Ekip DIN Rail Cartridge
- A20 = Unité d'actionnement type MOE AUTO-RESET pour la commande à moteur à accumulation d'énergie
- BUS1 = Interface série avec le bus extérieur
- BUS2 = Interface série redondant avec le bus extérieur
- LINK BUS = Interface avec le Link bus extérieur
- D = Temporisateur électronique de la bobine à minimum de tension YU, externe au disjoncteur (pour tensions jusqu'à 250V seulement)
- E = Adaptateur / convertisseur électronique pour bobines YO et YU, externe au disjoncteur
- H2 = Lampe de signalisation pour commande à moteur à accumulation d'énergie verrouillé
Lampe allumée= État manuel; Lampe éteinte= état automatique
- I 01-11...32 = Entrées numériques programmables
- I 41-51 = Entrées analogiques du capteur 4-20mA
- I 42...44 52...54 = Entrées analogiques du capteur de température
- I Pt100 = Entrée analogique du capteur de température Pt100 du moteur
- I reset = Entrée numérique pour la remise à zéro du déclenchement de l'unité de commande contacteur de démarrage moteur
- J... = Connecteurs pour les circuits auxiliaires du disjoncteur dans la version sur chariot, l'extraction des connecteurs se fait en même temps que le disjoncteur.
- K = Contacteur de démarrage du moteur
- K51 = Relais électronique de protection à maximum de courant type Ekip
- K51/CI = Module de commande contacteur de démarrage du moteur
- K51/COM = Module de communication
- K51/SIGN = Module de signalisation
- K51/SUPPLY = Module alimentation auxiliaire (110-240VAC/DC et 24-48VDC)
- K51/SYNC = Module Synchronisation
- K51/TEMP = Module de contrôle température
- K87 = Relai différentiel
- M = Moteur pour l'ouverture du disjoncteur et le bandage des ressorts de fermeture
- M1 = Moteur asynchrone triphasé
- O 01-11...32 = Contacts de signalisation programmables
- OCI = Contact pour la commande du contacteur de démarrage moteur
- O SC = Contact pour le contrôle de synchronisme
- Q = Interrupteur principal
- Q/0...7 = Contacts auxiliaires ouvert/fermé du disjoncteur
- Q/26 = Contacts auxiliaires ouvert/fermé utilisés à l'intérieur du déclencheur de protection
- R3 = Capteur de température Pt100 du moteur
- S1 = Contact commandé par la came de la commande à moteur
- S3/1-2 = Contacts commandés par le sélecteur Auto/Manual et par le verrouillage à clé de la commande à moteur

- S4/1-2 = Contacts auxiliaires anticipés actionnés par la poignée tournante du disjoncteur
- S51 = Contact de signalisation de disjoncteur ouvert pour intervention du déclencheur de protection à maximum de courant thermomagnétique ou du relais électronique
- S52 = Contact de signalisation intervention YU/YO
- S75E/1 = Contacts pour la signalisation électrique de disjoncteur en position débrosché (prévus seulement avec disjoncteurs dans la version débroschable)
- S75I/1-2-3 = Contacts pour la signalisation de disjoncteur en position embrosché (prévus seulement avec disjoncteurs dans la version déconnectable ou débroschable)
- S75T/1 = Contacts pour la signalisation électrique de disjoncteur en position de test (prévus seulement avec disjoncteurs dans la version débroschable)
- S87/1 = Contact pour la signalisation électrique de pré-alarme du relais différentiel
- S87/2 = Contact pour la signalisation électrique d'alarme du relais différentiel
- S87/3 = Contact pour la signalisation électrique de disjoncteur ouvert par intervention du relais différentiel
- SC = Bouton-poussoir ou contact de fermeture du disjoncteur
- SC3 = Bouton-poussoir de démarrage du moteur
- SD = Sectionneur de l'alimentation du relais différentiel
- SO = Bouton-poussoir ou contact d'ouverture du disjoncteur
- SO3 = Bouton-poussoir pour l'arrêt du moteur
- SR = Bouton-poussoir ou contact de remise à zéro électrique
- SY/1...3 = Contacts de signalisation de disjoncteur ouvert pour intervention du relais de protection à maximum de courant, du déclencheur thermomagnétique et des bobines YO, YO2, YU (position de déclenché)
- TI = Transformateur de courant torique
- TI/L1-L2-L3 = Transformateur de courant phase L1-L2-L3
- TI/N = Transformateur de courant sur le neutre
- TU2 = Transformateur de tension d'isolement (extérieur au disjoncteur)
- Uaux = Tension d'alimentation auxiliaire
- V1 = Applications du disjoncteur
- V2 = Applications de la commande à moteur
- V4 = Appareils et raccordements indicatifs pour commande et signalisation, extérieurs au disjoncteur
- V5 = Applications du porte élément de remplacement Ekip DIN Rail Cartridge Basic ou Ekip DIN Rail Cartridge
- W2 = Interface série avec le bus interne (Local Bus)
- W9...14 = Connecteur RJ45 pour unités d'interface et pour modules de communication
- W9R...12R = Connecteur RJ45 pour modules communication redondants
- X3-X4-X8 = Connecteurs du relais de protection
- XB.. = Connecteur à trois voies pour les circuits auxiliaires du disjoncteur en version déconnectable
- XC.. = Connecteur à six voies pour les circuits auxiliaires du disjoncteur version déconnectable
- XC2-3 = Connecteur à six voies pour les circuits auxiliaires du disjoncteur version déconnectable pour tensions jusqu'à 400V
- XCT1-2 = Borniers du porte élément de remplacement Ekip DIN Rail Cartridge Basic ou Ekip DIN Rail Cartridge
- XD.. = Connecteur à neuf voies pour les circuits auxiliaires du disjoncteur version déconnectable
- XE.. = Connecteur à quinze voies pour les circuits auxiliaires du disjoncteur en version déconnectable
- XF.. = Connecteur de l'unité d'interface type Ekip Com
- XH1 = Connecteur du relais de protection
- XV = Borniers des applications du disjoncteur
- YC = Bobine de fermeture de la commande par moteur à accumulation d'énergie
- YO = Bobine d'ouverture
- YO1 = Bobine d'ouverture à maximum de courant
- YO2 = Bobine d'ouverture du relais différentiel
- YU = Bobine à minimum de tension
- YU/O = Bobine à minimum de tension et d'ouverture (Combo)

REMARQUES

- A. Pour les fonctions de sélectivité de zone et de Local bus la présence d'alimentation auxiliaire est nécessaire (voir Fig. 41-78).
- B. La bobine à minimum de tension est fournie pour alimentation dérivée en amont du disjoncteur ou par une source indépendante : la fermeture du disjoncteur est permise seulement avec bobine excitée (le verrouillage de la fermeture est réalisé mécaniquement).
- C. Les contacts S4/1 et S4/2 des figures 7-10-15 ouvrent le circuit quand le disjoncteur est ouvert et le referment quand est réalisée une commande de fermeture manuelle par poignée rotative, conformément aux Normes relatives aux machines outils (la fermeture n'a quand même pas lieu si le déclencheur à minimum de tension n'est pas alimenté).
- D. = Seulement pour XT5 F-P.
- E. = Seulement pour XT5.
- G. En cas de disjoncteur tripolaire en version fixe avec transformateur de courant sur conducteur neutre extérieur au disjoncteur, quand on veut enlever le disjoncteur il faut court-circuiter les bornes du transformateur TI/N.
- H. Etant donné qu'une Vaux isolée de la terre est requise, il faut utiliser des " convertisseurs séparés galvaniquement " conformes aux normes IEC 60950 (UL 1950) ou ses équivalents.
- I. Obligatoire en cas de présence de n'importe quel module Ekip.
- L. En cas de porte-élément de remplacement Ekip DIN Rail Cartridge Basic une seule application peut être fournie entre les Fig. 79...93-131-132.

En cas de porte-élément de remplacement Ekip DIN Rail Cartridge trois applications peuvent être fournies entre les Fig. 79...93-131-132 prises une seule fois. Il est aussi possible de dupliquer le module Ekip Com éventuellement sélectionné en choisissant entre les Fig. 110...116.

- M. Pour le fonctionnement correct au moins un module E doit toujours être présent.kip Supply plus au moins moins un module.
- N. Il faut utiliser des câbles type BELDEN 3105A ou équivalent.
- O. En présence de plusieurs modules Ekip Com avec disjoncteurs dans la version débrochable, le contact S751/2 doit être connecté une seule fois sur un seul module.
- P. La tension auxiliaire Uaux. permet l'activation de la totalité des fonctionnalités des relais de protection électroniques EKIP. Etant donné qu'une Vaux isolée de la terre est requise, il faut utiliser des "convertisseurs séparés galvaniquement" conformes aux normes IEC 60950 (UL 1950) ou ses équivalents.
- Q. Il faut utiliser des câbles type BELDEN 3105A ou équivalent, d'une longueur maximale de 15m.
- R. Câble RJ45 suggéré : CAT6 STP.
- S. Pour le raccordement de la ligne série EIA RS485 voir le "Cahier Application Technique - vol. 9 : La communication via BUS avec les disjoncteurs ABB".
- T. Court-circuiter les bornes 120Ω si on désire introduire une résistance de terminaison sur le Local Bus.
- U. Utiliser des câbles Belden type 3079A ou équivalent. Pour plus de détails voir la Présentation Technique 1SDC007412G0201 "Communication avec le disjoncteur SACE Emax 2".
- V. Utiliser des câbles Belden type 3084A ou équivalent. Pour plus de détails voir la Présentation Technique 1SDC007412G0201 "Communication avec le disjoncteur SACE Emax 2".
- Z. Pour l'alimentation au relais électronique à travers les bornes K1 et K2 il n'est pas possible d'utiliser Ekip Supply.
- AA. Pour la connexion de W3 et W4 voir Fig. 78.
- AB. Utiliser un câble bipolaire et blindé type BELDEN 8762/8772 ou équivalent. Le blindage doit être mis à la terre côté entrée de sélectivité (pour sélectivité de zone) ou des deux côtés (pour les autres applications).
- AC. La tension secondaire assignée est de 120V.
- AD. Utiliser des câbles isolés pour thermocouples type PENTRONIC TEC/SITW-24F (type TX)

DISJONCTEUR XT6 TRIPOLAIRE ET TÉTRAPOLAIRE DANS LA VERSION DEBROCHABLE

Les applications indiquées dans les figures peuvent être fournies 1-2-5-6-7-8-9-10-11-12-15-18-20-21-23-24-28-29-40.

Le tableau suivant indique les incompatibilités entre les différentes applications (X = applications incompatibles):

1												
2												
5	x											
8		x										
11	x		x									
12		x		x								
18												
20												
21								x				
23												
24								x		x		
	1	2	5	8	11	12	18	20	21	23	24	

ESTADO DE FUNCIONAMIENTO REPRESENTADO

El esquema está representado en las siguientes condiciones:

- interruptor en ejecución extraíble o enchufable, abierto e insertado
- contactor para el arranque del motor abierto
- circuitos sin tensión
- relés sin actuar

NOTAS

* = Véase la nota indicada con la letra

A12 = Unidad de interfaz tipo Ekip Com

A13 = Unidad de señalización tipo Ekip Signalling 10K

A14 = Unidad de actuación tipo MOE-E para el mando a motor con acumulación de energía

A15 = Unidad medidas tipo Ekip Multimeter

A16 = Unidad de interfaz tipo Ekip Micro Module I/O

A17 = Unidad de actuación tipo MOE para el mando a motor con acumulación de energía

A18 = Ekip DIN Rail Cartridge Basic

A19 = Ekip DIN Rail Cartridge

A20 = Unidad de actuación tipo MOE AUTO-RESET para el mando a motor con acumulación de energía

BUS1 = Interfaz serial con el bus externo

BUS2 = Interfaz serial redundante con el bus externo

LINK BUS = Interfaz con el Link bus externo

D = Retardador electrónico de la bobina de mínima tensión YU, externo al interruptor (sólo para tensiones de hasta 250V)

E = Adaptador / convertidor electrónico para bobinas YO y YU, externo al interruptor

H2 = Lámpara de señalización para el mando a motor con acumulación de energía bloqueado
Lámpara encendida = Estado manual; Lámpara apagada = Estado automático

I 01-11...32 = Entradas digitales programables

I 41-51 = Entradas analógicas de sensor 4-20mA

I 42...44 52...54 = Entradas analógicas de sensor de temperatura

I Pt100 = Entrada analógica de sensor de temperatura Pt100 del motor

I reset = Entrada digital para el reset del disparo de la unidad de mando del contactor de arranque motor

J... = Conectores para los circuitos auxiliares del interruptor en ejecución extraíble, la extracción de los conectores se produce simultáneamente con la del interruptor

K = Contactor para el arranque del motor

K51 = Relé electrónico de protección de máxima corriente tipo Ekip

K51/CI = Módulo de mando contactor para el arranque del motor

K51/COM = Módulo de comunicación

K51/SIGN = Módulo de señalización

K51/SUPPLY = Módulo de alimentación auxiliar (110-240VAC/DC y 24-48VDC)

K51/SYNC = Módulo de sincronización

K51/TEMP = Módulo de control temperatura

K87 = Relé diferencial

M = Motor para la apertura del interruptor y la carga de los resortes de cierre

M1 = Motor asincrónico trifásico

O 01-11...32 = Contactos de señalización programables

O CI = Contacto para el mando del contactor de arranque motor

O SC = Contacto para el control de sincronismo

Q = Interruptor principal

Q/0...7 = Contactos auxiliares abierto/cerrado del interruptor

Q/26 = Contactos auxiliares abierto/cerrado usados en el interior del relé de protección

R3 = Sensor de temperatura Pt100 del motor

S1 = Contacto controlado por la leva del mando a motor

S3/1-2 = Contactos controlados por el selector Auto/Manual y por el bloqueo de llave del mando motor

S4/1-2 = Contactos auxiliares anticipados accionados por el mando giratorio del interruptor

S51 = Contacto de señalización de interruptor abierto por actuación del relé de protección de máxima corriente termomagnético o del relé electrónico

S52 = Contacto de señalización actuación YU/YO
 S75E/1 = Contacto para la señalización de interruptor en posición de extraído (previsto sólo con interruptores en ejecución extraíble)
 S75I/1-2-3 = Contactos para la señalización de interruptor en posición de insertado (previstos sólo con interruptores en ejecución enchufable o extraíble)
 S75T/1 = Contacto para la señalización de interruptor en posición de test (previsto sólo con interruptores en versión extraíble)
 S87/1 = Contacto para la señalización eléctrica de prealarma del relé diferencial
 S87/2 = Contacto para la señalización eléctrica de alarma del relé diferencial
 S87/3 = Contacto para la señalización eléctrica de interruptor abierto por actuación del relé diferencial
 SC = Pulsador o contacto para el cierre del interruptor
 SC3 = Pulsador para el arranque del motor
 SD = Seccionador de la alimentación del relé diferencial
 SO = Pulsador o contacto para la apertura del interruptor
 SO3 = Pulsador para la parada del motor
 SR = Pulsador o contacto de reset eléctrico
 SY/1...3 = Contactos de señalización de interruptor abierto por actuación del relé de protección de máxima corriente, del relé termomagnético y de las bobinas YO, YO1, YO2, YU (posición de disparado)
 TI = Transformador de corriente toroidal
 TI/L1-L2-L3 = Transformador de corriente fase L1-L2-L3
 TI/N = Transformador de corriente en el neutro
 TU2 = Transformador de tensión de aislamiento (externo al interruptor)
 Uaux = Tensión de alimentación auxiliar
 V1 = Aplicaciones del interruptor
 V2 = Aplicaciones del mando a motor
 V4 = Aparatos y conexiones indicativos para mando y señalización, externos al interruptor
 V5 = Aplicaciones de los módulos tipo cartucho Ekip DIN Rail Cartridge Basic o Ekip DIN Rail Cartridge
 W2 = Interfaz serial con el bus interno (bus local)
 W9...14 = Conector RJ45 para unidad de interfaz y para módulos de comunicación
 W9R...12R = Conector RJ45 para módulos de comunicación redundantes
 X3-X4-X8 = Conectores del relé de protección
 XB.. = Conector de tres vías para los circuitos auxiliares del interruptor en ejecución enchufable
 XC.. = Conector de seis vías para los circuitos auxiliares del interruptor en ejecución enchufable
 XC2-3 = Conector de seis vías para los circuitos auxiliares del interruptor en ejecución enchufable para tensiones de hasta 400V
 XCT1-2 = Regleta de bornes de los módulos tipo cartucho Ekip DIN Rail Cartridge Basic o Ekip DIN Rail Cartridge
 XD.. = Conector de nueve vías para los circuitos auxiliares del interruptor en ejecución enchufable
 XE.. = Conector de quince vías para los circuitos auxiliares del interruptor en ejecución enchufable
 XF.. = Conector de la unidad de interfaz tipo Ekip Com
 XH1 = Conector del relé de protección
 XV = Regleta de bornes de las aplicaciones del interruptor
 YC = Bobina de cierre del mando a motor con acumulación de energía
 YO = Bobina de apertura
 YO1 = Bobina de apertura para máxima corriente
 YO2 = Bobina de apertura del relé diferencial
 YU = Bobina de mínima tensión
 YU/O = Bobina de mínima tensión y de apertura (Combo)

NOTAS

A. Para las funciones de selectividad de zona y bus local es necesaria la presencia de alimentación auxiliar (véase Fig. 41-78).

- B. La bobina de mínima tensión se suministra para alimentación derivada aguas arriba del interruptor o de una fuente independiente: está permitido el cierre del interruptor sólo con la bobina excitada (el bloqueo del cierre se logra mecánicamente).
- C. Los contactos S4/1 y S4/2 de la Fig. 7-10-15 abren el circuito con interruptor abierto y lo vuelven a cerrar cuando se da un mando de cierre manual, mediante mando giratorio, de conformidad con las Normas relativas a las máquinas herramientas (el cierre no se produce si la bobina de mínima tensión no está alimentada).
- D. = Solo para XT5 F-P.
- E. = Solo para XT5.
- G. = En el caso de interruptor tripolar en ejecución fija con transformador de corriente en conductor neutro externo al interruptor, para sacar el interruptor es necesario cortocircuitar los bornes del transformador TI/N.
- H. Al requerirse una corriente Uaux aislada de tierra, es necesario utilizar "convertidores galvánicamente separados" conformes con las normas IEC 60950 (UL 1950) o equivalentes.
- I. Obligatorio si está presente cualquier módulo Ekip.
- L. En caso de módulo tipo cartucho Ekip DIN Rail Cartridge Basic puede ser suministrada una sola aplicación entre las Fig. 79...93-131-132.
En caso de módulo tipo cartucho Ekip DIN Rail Cartridge pueden ser suministradas hasta tres aplicaciones entre las Fig. 79...93-131-132 consideradas una sola vez. Es posible además duplicar el módulo Ekip Com eventualmente seleccionado eligiendo entre las Fig. 110...116.
- M. Para el funcionamiento correcto debe estar presente siempre el módulo Ekip Supply más otro módulo por lo menos.
- N. Deben usarse cables tipo BELDEN 3105A o equivalente.
- O. En presencia de varios módulos Ekip Com con interruptores en ejecución extraíble, el contacto S75I/2 deberá conectarse una sola vez en un solo módulo.
- P. La tensión auxiliar Uaux. permite activar todas las funcionalidades de los relés de protección electrónicos EKIP. Al requerirse una corriente Uaux aislada de tierra, es necesario utilizar "convertidores galvánicamente separados" conformes con las normas IEC 60950 (UL 1950) o equivalentes.
- Q. Se deberán usar cables tipo BELDEN 3105A o equivalente, con longitud máxima de 15m.
- R. Cable RJ45 sugerido: CAT6 STP.
- S. Para la conexión de la línea serial EIA RS485 véase el "Cuaderno Aplicación Técnica - vol. 9: La Comunicación vía BUS con los interruptores ABB".
- T. Cortocircuitar los bornes 120Ω on si se desea insertar una resistencia de terminación en el Bus local.
- U. Usar cables Belden tipo 3079A o equivalente. Para más información véase el informe técnico 1SDC007412G0201 "Comunicación con interruptor SACE Emax 2".
- V. Usar cables Belden tipo 3084A o equivalente. Para más información véase el informe técnico 1SDC007412G0201 "Comunicación con interruptor SACE Emax 2".
- Z. Para la alimentación al relé electrónico mediante bornes K1 y K2 no es posible utilizar Ekip Supply.
- AA. Para la conexión de W3 y W4 véanse las Fig. 78.
- AB. Utilizar cable bipolar apantallado tipo BELDEN 8762/8772 o equivalente. La pantalla debe ser conectada a tierra del lado entrada de selectividad (para selectividad de zona) o de ambos lados (para otras aplicaciones).
- AC. La tensión secundaria asignada máxima es de 120V.
- AD. Utilizar cables aislados por termopares tipo PENTRONIC TEC/SITW-24F (tipo TX) o equivalente, de longitud no superior a 3m.
- AE. Utilizar cables idóneos y compatibles con el ambiente de trabajo en el cual se utilizará el sensor de corriente 4-20mA, con una longitud no superior a 3m.
- AF. La conexión se deberá efectuar con el cable suministrado; no está permitida la interrupción del cable y no se admite el uso de otros cables ni su extensión mediante regletas de conexión intermedias. Con interruptor, si no está presente el neutro externo, los polos del conector del

INTERRUPTOR XT6 TRIPOLAR O TETRAPOLAR EN EJECUCIÓN FIJA

Pueden ser suministradas las aplicaciones indicadas en las figuras 1-2-5-6-7-8-9-10-11-12-15-18-20-21-23-24-39-40.

La siguiente tabla indica las incompatibilidades entre las diversas aplicaciones (X= aplicaciones incompatibles):

1												
2												
5	x											
8		x										
11	x		x									
12			x		x							
18												
20												
21								x				
23												
24								x		x		
	1	2	5	8	11	12	18	20	21	23	24	

INTERRUPTOR XT6 TRIPOLAR O TETRAPOLAR EN EJECUCIÓN ENCHUFABLE

Pueden ser suministradas las aplicaciones indicadas en las figuras 1-2-5-6-7-8-9-10-11-12-15-18-20-21-23-24-39-40.

La siguiente tabla indica las incompatibilidades entre las diversas aplicaciones (X= aplicaciones incompatibles):

1												
2												
5	x											
8		x										
11	x		x									
12			x		x							
18												
20												
21								x				
23												
24								x		x		
	1	2	5	8	11	12	18	20	21	23	24	

INTERRUPTOR XT6 TRIPOLAR O TETRAPOLAR EN EJECUCIÓN EXTRAÍBLE

Pueden ser suministradas las aplicaciones indicadas en las figuras 1-2-5-6-7-8-9-10-11-12-15-18-20-21-23-24-28-29-40.

La siguiente tabla indica las incompatibilidades entre las diversas aplicaciones (X= aplicaciones incompatibles):

1												
2												
5	x											
8		x										
11	x		x									
12			x		x							
18												
20												
21								x				
23												
24								x		x		
	1	2	5	8	11	12	18	20	21	23	24	

W9...14= 通信模块RJ45连接器
W9R...12R = 冗余通信模块RJ45连接器
X = 抽出式断路器辅助电路馈电连接器
XB1...7 = 断路器应用连接器
XF = 抽出式断路器位置触点馈电端子盒

表示的运行状态

表示的运行状态

该图表示以下条件:

- 可抽取式或可拆卸式断路器断开和插入
- 电机启动接触器打开
- 回路无电压
- 启动器未干预

缩略语

. = 参阅字母所指的注释
A12 = Ekip Com 型接口单元
A13 = Ekip Signalling 10K 型信号单元
A14 = 用于储能电机驱动的MOE-E型执行单元
A15 = Ekip 万用表型测量单元
A16 = Ekip 微型模块I/O 接口单元
A17 = 用于储能电机驱动的MOE型执行单元
A18 = Ekip DIN Rail Cartridge Basic 基本款导轨盒
A19 = Ekip DIN Rail Cartridge 导轨盒
A20 = 用于储能电机驱动的MOE AUTO-RESET型执行单元
BUS1 = 与外部总线的串行接口
BUS2 = 与外部总线的冗余串行接口
LINK BUS = 与外部总线链接的接口
D = 断路器外部的欠压线圈YU电子延迟器 (仅适用于250V以下的电压)
E = YO,YU / , 置于断路器外部
H2 = 用于储能电机驱动的信号灯 所有继电器的指示灯必须按顺序点亮
I 01-11...32 = 可编程数字输入
I 41-51 = 4-20mA传感器的模拟输入
I 42...44 52...54 = 温度传感器的模拟输入
I Pt100 = 电机Pt100温度传感器的模拟输入
I reset = 用于复位电机启动接触器的控制单元释放的数字输入
J ... = 可抽取式断路器辅助电路的连接器, 连接器的拔出与断路器的拔出同时进行
K = 用于启动电机的接触器
K51 = Ekip 型最大电流保护电子继电器
K51/CI = 用于电机起动的接触器控制模块
K51/COM = 通信模块
K51/SIGN = 信号模块
K51/SUPPLY = 辅助电源模块 (110-240VAC/DC 和 24-48VDC)
K51/SYNC = 同步模块
K51/TEMP = 温度控制模块
K87 = 差动继电器
M = 用于打开断路器和加载闭合弹簧的电机
M1 = 三相异步电机
O 01-11...32 = 可编程的信号触点
OCI = 用于控制电机启动接触器的触点
O SC = 用于控制同步的触点
Q = 主断路器
Q/0...7 = 断路器断开/闭合的辅助触点
Q/26 = 内部通过保护脱扣实现的分/合闸辅助触点
R3 = 电机Pt100温度传感器
S1 = 触点受电机驱动凸轮控制
S3/1-2 = 触点由Auto/Manual (自动/手动) 选择器和电机驱动钥匙锁控制
S4/1-2 = 由断路器旋转手柄操作的推进辅助触点
S51 = 由于热磁最大电流保护脱扣器干预或电子继电器干预, 断路器的信号触点断开
S52 = YU/YO干预指示信号触点
S75E/1 = 断路器在抽出位置的信号触点 (仅适用于具有可抽取式断路器的情形)
S75/1-2-3 = 断路器在插入位置的信号触点 (仅适用于具有可拆卸式或可抽取式断路器的情形)
S75T/1 = 断路器在热磁测试位置 (仅适用于具有可抽取式断路器的情形) 和
S87/1 = 差动继电器的电子预警信号触点
S87/2 = 差动继电器的电子报警信号触点

S87/3	=	由于差动继电器的干预，断路器的电子信号触点断开
SC	=	断路器闭合的按钮或触点
SC3	=	用于启动电机的按钮
SD	=	差动继电器的电源切断开关
SO	=	断路器打开的按钮或触点
SO3	=	用于停止电机的按钮
SR	=	电气复位的按钮或触点
SY/1...3	=	由于热磁脱扣器和YO、YO1、YO2、YU线圈（跳闸位置）的过电流保护继电器跳闸，断路器的信号触点断开。
TI	=	环形电流互感器
TI/L1-L2-L3	=	L1-L2-L3 相位电流互感器
TI/N	=	电流互感器在中性
TU2	=	隔离电压互感器（断路器外部）
Uaux	=	辅助电源电压
V1	=	断路器的应用
V2	=	电机驱动应用
V4	=	用于断路器外部控制和信号的参考设备和连接
V5	=	Ekip DIN 基本款导轨盒或Ekip DIN 导轨盒的应用
W2	=	与内部总线的串行接口（本地总线）
W9...14	=	用于接口单元和通信模块的连接器RJ45
W9R...12R	=	用于冗余通信模块的连接器RJ45
X3-X4-X8	=	保护继电器的连接器
XB..	=	用于可拆卸断路器辅助电路的三通连接器
XC..	=	用于可拆卸断路器辅助电路的六路连接器
XC2-3	=	用于可拆卸断路器辅助电路的六路连接器，电压在400V以下
XCT1-2	=	Ekip DIN 基本款导轨盒或Ekip DIN 导轨盒的端子板
XD..	=	用于可拆卸断路器辅助电路的九路连接器
XE..	=	用于可拆卸断路器辅助电路的十五路连接器
XF..	=	Ekip Com 型接口单元连接器
XH1	=	保护继电器的连接器
XV	=	断路器应用端子板
YC	=	储能电机驱动的闭合线圈
YO	=	开启线圈
YO1	=	最大电流开启线圈
YO2	=	差动继电器开启线圈
YU	=	最小电压线圈
YU/O	=	最低电压和开路线圈（Combo）

注

- A. 为使用区域和局部总线选择功能，必须存在辅助电源（见图41-78）。
 - B. 欠压线圈用于来自断路器上游的电源或独立电源：断路器只能在线圈通电时才能闭合（闭合的锁定是机械地进行的）。
 - C. 图7-10-15 的触点S4/1和S4/2在断路器打开时打开电路，当通过旋转手柄手动关闭命令时则关闭电路，均符合与机床相关的标准（欠压线圈如果未通电，就不会关闭电路）。
 - D. = 仅针对XT5 F-P。
 - E. = 仅针对XT5。
 - F. 如果是固定型的三极断路器，且在断路器外部的中性导线上带有电流互感器，则在移除断路器时，必须使 TI/N 变压器的端子短路。
 - G. 由于地面需要隔离的Uaux，必须使用符合IEC 60950（UL 1950）或其等效标准的“电隔离转换器”。
 - H. 在存在任何Ekip 模块的情况下必须提供。
 - I. 使用Ekip DIN 基本款导轨盒时，只可提供图79...93-131-132 之间的一种应用。
使用Ekip DIN 导轨盒时，最多可提供图79...93-131-132 之间的三种应用。也可以在图110...116 之间选择来复制选定的Ekip Com 模块。
 - M. 为能正确运行，必须始终存在Ekip Supply 模块加上至少另外一个模块。
 - N. 应使用BELDEN 3105A型或等效的电缆。
 - O. 在带有可抽取式断路器的多个Ekip Com 模块存在的条件下，S75/2 触点只能一次性连接一个模块。
 - P. 辅助电压Uaux允许激活EKIP电子保护继电器的全部功能。由于地面需要隔离的Uaux，必须使用符合IEC 60950（UL 1950）或其等效标准的“电隔离转换器”。
- 数量 应使用BELDEN 3105A型或等效的电缆，最大长度15米。
- R. 建议的RJ45电缆：CAT6 STP。

可抽取式三极和四极断路器XT6

可提供图1-2-5-6-7-8-9-10-11-12-15-18-20-21-23-24-28-29-40中所示的应用

下表指出了各应用之间的不兼容性 (X=不兼容的应用) :

1												
2												
5	x											
8		x										
11	x		x									
12		x		x								
18												
20												
21								x				
23												
24								x		x		
	1	2	5	8	11	12	18	20	21	23	24	