

# Productinformatieblad

Specificaties



## Dubbele drukknop, Verzonken / uitstekend, Ø22mm, "STOP", Zonder kap

ZB4BA791

EAN Code: 3389119043717

**Prijs: 23,00 EUR**

### Hoofd

range of product	Harmony XB4
product of component type	Knop voor drukknop met drie mogelijkheden
device short name	ZB4
kraag materiaal	Verchroomd metaal
bevestigingsdiameter	22 mm
verkoop per ondeelbare hoeveelheid	1
koptype	Standaard
vorm van kop signaleringseenheid	Rechthoekig
type operator	terugverend
operator profiel	2 standaard knoppen - 1 verhoogde STOP-knop
operatorbeschrijving	Zwarte drukknoppen zonder dop - rode "STOP"

### Complementair

gewicht product	0,056 kg
weerstand hoge druk drukring	7000000 Pa om 55 °C, afstand: 0.1 m
kleur van markering	Zwarte markering bij witte schildjes Witte markering bij groene, rode of zwarte schildjes
operator profiel	Rood uitspringend, STOP (wit) zonder dop
mechanical durability	1000000 cycles
elektrische samenstellingscode	C1 voor <9 contacten gebruik enkelvoudig blokken in vooraan gemonteerd C2 voor <9 contacten gebruik enkelvoudig en dubbel blokken in vooraan gemonteerd C11 voor <3 contacten gebruik enkelvoudig blokken in vooraan gemonteerd
product presentatie	Basisonderdeel

### Omgeving

ambient air temperature for storage	-40...70 °C
omgevingstemperatuur voor werking	-25...70 °C
beschermingsklasse tegen elektrische schokken	Klasse I In overeenstemming met IEC 60536
IP beschermingsgraad	IP69 In overeenstemming met IEC 60529
Enclosure Type	UL type 4X/13
IK-beschermingsgraad	IK06 In overeenstemming met IEC 50102

De weergegeven prijs is de adviesprijs in euro excl. BTW. Deze kan onderhevig zijn aan korting. Neem contact op met uw lokale distributeur of detailhandel voor de daadwerkelijke prijs

<b>standards</b>	IEC 60947-5-4 JIS C8201-5-1 IEC 60947-1 IEC 60947-5-1 CSA C22.2 Nr 14 IEC 60947-5-5 UL 508 JIS C8201-1
<b>product certifications</b>	CSA LROS (Lloyds register of shipping) BV UL listed DNV
<b>trilling bestendigheid</b>	5 gn (f= 2...500 Hz) In overeenstemming met IEC 60068-2-6
<b>schokbestendigheid</b>	30 gn (duur = 18 ms) voor halve sinusgolf versnelling In overeenstemming met IEC 60068-2-27 50 gn (duur = 11 ms) voor halve sinusgolf versnelling In overeenstemming met IEC 60068-2-27

## Verpakkingseenheid

<b>Eenheidstype van verpakking 1</b>	PCE
<b>Aantal eenheden in verpakking 1</b>	1
<b>verpakking 1 hoogte</b>	5,500 cm
<b>verpakking 1 breedte</b>	3,300 cm
<b>verpakking 1 lengte</b>	5,300 cm
<b>verpakking_1_gewicht</b>	57,000 g
<b>Eenheidstype van verpakking 2</b>	S03
<b>Aantal eenheden in verpakking 2</b>	200
<b>verpakking 2 hoogte</b>	30,000 cm
<b>verpakking 2 breedte</b>	30,000 cm
<b>verpakking 2 lengte</b>	40,000 cm
<b>verpakking 2 gewicht</b>	11,960 kg

## contractuele waarborg

<b>Garantie (in maanden)</b>	18
------------------------------	----

Schneider Electric wil tegen 2050 de Net Zero-status hebben bereikt via partnerschappen in de toeleveringsketen, materialen met een lagere impact en circulariteit via onze doorlopende campagne "Use Better, Use Longer, Use Again" om de levensduur van producten en de recycleerbaarheid te verlengen.

[Uitleg van Environmental Data >](#)

[Hoe evalueren we de duurzaamheid van producten? >](#)

### Milieuoetafdruk

Totale levenscyclus ecologische voetafdruk	0.5 kg CO2 eq.
Koolstofvoetafdruk van de fabricagefase [A1–A3]	0.4 kg CO2 eq.
Koolstofvoetafdruk van de distributiefase [A4]	0 kg CO2 eq.
Koolstofvoetafdruk van de installatiefase [A5]	0 kg CO2 eq.
Koolstofvoetafdruk van de gebruiksfase [B2, B3, B4, B6]	0 kg CO2 eq.
Koolstofvoetafdruk van de einde-levensfase [C1–C4]	0.1 kg CO2 eq.

## Use Better

### Materialen en verpakking

Gemiddeld percentage gerecycleerde kunststof	14 %
Gemiddeld percentage gerecycleerd metaal	21 %
Pakket met gerecycleerd karton	Ja
Verpakkingen zonder kunststof	Ja
RoHS-richtlijn van de EU	<a href="#">Conform</a>
REACH-verordening	<a href="#">Referentie bevat geen SVHC boven drempelwaarde</a>

## Use Longer

### Levensduurverlenging

Reparatie	Nee
-----------	-----

## Use Again

### Herverpakken en herfabriceren

Circulair Profiel	<a href="#">Informatie over einde levensduur</a>
Terugname	Ja

Dimensions Drawings

Dimensions

---

Without Boot

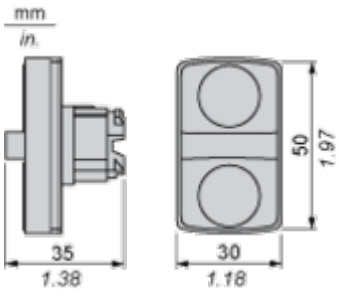

With Boot ZBA709

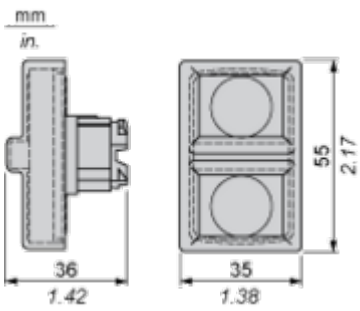

Mounting and Clearance

Panel Cut-out for Pushbuttons, Switches and Pilot Lights (Finished Holes, Ready for Installation)

Connection by Screw Clamp Terminals or Plug-in Connectors or on Printed Circuit Board	Connection by Faston Connectors
	
<p>(1) Diameter on finished panel or support                  (2) 40 mm min. / 1.57 in. min.                  (3) 30 mm min. / 1.18 in. min.                  (4) <math>\varnothing 22.5 \text{ mm} / 0.89 \text{ in.}</math> recommended (<math>\varnothing 22.3 \text{ mm} \begin{smallmatrix} +0.4 \\ 0 \end{smallmatrix} / 0.88 \text{ in.} \begin{smallmatrix} +0.016 \\ 0 \end{smallmatrix}</math>)                  (5) 45 mm min. / 1.78 in. min.                  (6) 32 mm min. / 1.26 in. min.</p>	

Pushbuttons, Switches and Pilot Lights for Printed Circuit Board Connection

Panel Cut-outs (Viewed from Installer's Side)



A: 30 mm min. / 1.18 in. min.

B: 40 mm min. / 1.57 in. min.

Printed Circuit Board Cut-outs (Viewed from Electrical Block Side)

Dimensions in mm



A: 30 mm min.

B: 40 mm min.

Dimensions in in.

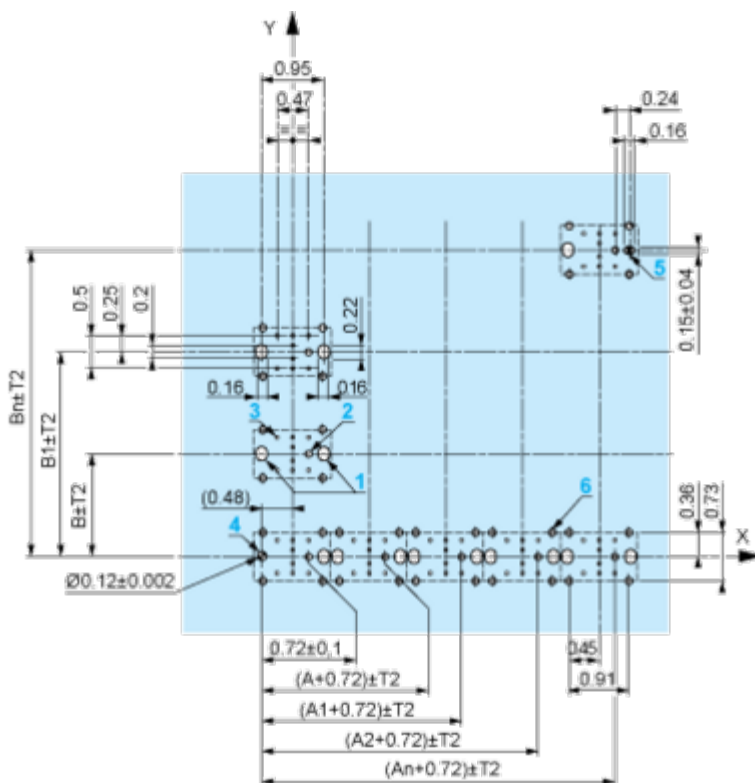

A: 1.18 in. min.

B: 1.57 in. min.

**General Tolerances of the Panel and Printed Circuit Board**

The cumulative tolerance must not exceed 0.3 mm / 0.012 in: T1 + T2 = 0.3 mm max.

**Installation Precautions**

- Minimum thickness of circuit board: 1.6 mm / 0.06 in.
- Cut-out diameter: 22.4 mm ± 0.1 / 0.88 in. ± 0.004
- Orientation of body/fixing collar ZB4 BZ009: ± 2° 30' (excluding cut-outs marked a and b).
- Tightening torque of screws ZBZ 006: 0.6 N.m (5.3 lbf.in) max.
- Allow for one ZB4 BZ079 fixing collar/pillar and its fixing screws:
  - every 90 mm / 3.54 in. horizontally (X), and 120 mm / 4.72 in. vertically (Y).
  - with each selector switch head (ZB4 BD\*, ZB4 BJ\*, ZB4 BG\*).

The fixing centers marked a and b are diagonally opposed and must align with those marked 4 and 5.



(1) Panel

(2) Printed circuit board

#### Mounting of Adapter (Socket) ZBZ 01•

- 1 2 elongated holes for ZBZ 006 screw access
- 2 1 hole  $\varnothing 2.4 \text{ mm} \pm 0.05 / 0.09 \text{ in.} \pm 0.002$  for centring adapter ZBZ 01•
- 3  $8 \times \varnothing 1.2 \text{ mm} / 0.05 \text{ in.}$  holes
- 4 1 hole  $\varnothing 2.9 \text{ mm} \pm 0.05 / 0.11 \text{ in.} \pm 0.002$ , for aligning the printed circuit board (with cut-out marked a)
- 5 1 elongated hole for aligning the printed circuit board (with cut-out marked b)
- 6 4 holes  $\varnothing 2.4 \text{ mm} / 0.09 \text{ in.}$  for clipping in adapter ZBZ 01•

Dimensions An + 18.1 relate to the  $\varnothing 2.4 \text{ mm} \pm 0.05 / 0.09 \text{ in.} \pm 0.002$  holes for centring adapter ZBZ 01•.

Technical Description

Electrical Composition Corresponding to Code C1

---



Electrical Composition Corresponding to Code C2

---

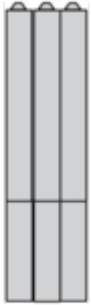

Electrical Composition Corresponding to Codes C9, C11, SF1 and SR1



**Legend**

---

Single contact



Double contact



Light block



Possible location



Technical Illustration

Dimensions

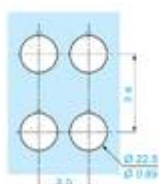
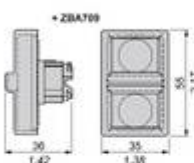
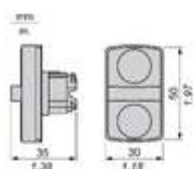

		a (mm)	a (in.)	b (mm)	b (in.)
		40	1.57	30	1.18
ZBE*****	ZBV*****				
		45	1.77	32	1.26
ZBE*****5	ZBV*****5				
		40	1.57	30	1.18
ZBE*****1	ZBV*****1				
		50	1.97	30	1.18
ZBE*****5	ZBV*****5				
		40	1.57	30	1.18
ZBE*****9	ZBV*****9				
		40	1.57	30	1.18
ZBR1*	ZBRV1				