

Data Sheet | Item Number: 831-503

Strain relief plate; for female and male connectors; 15 mm wide; 1 part; Pin spacing 7.62 mm; light gray

<https://www.wago.com/831-503>

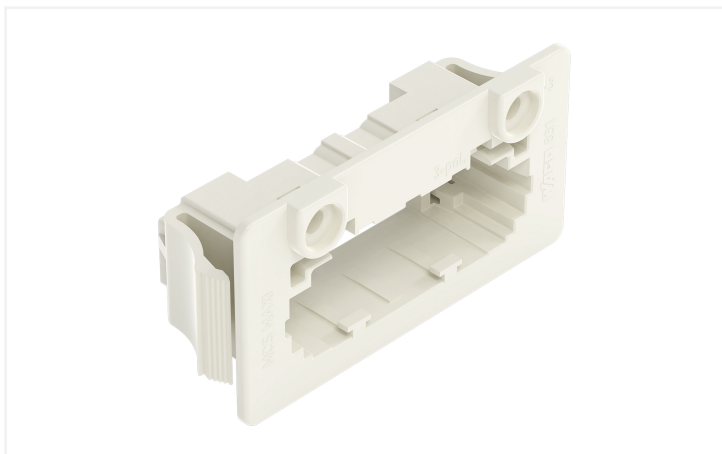

Color: ■ light gray

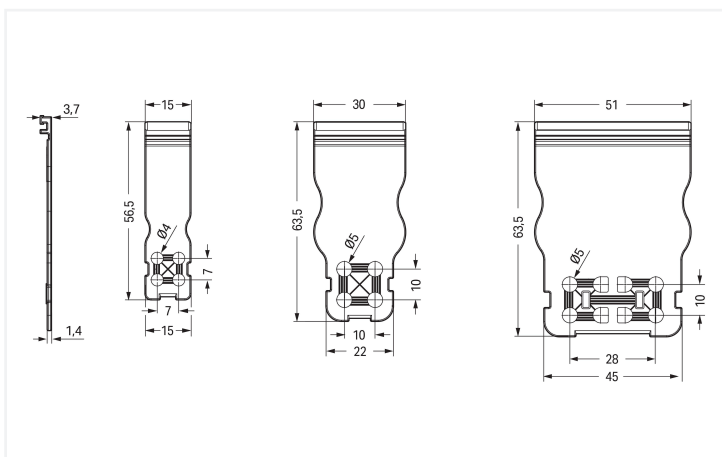

Dimensions in mm

The arrangement of the attachments for cable ties allows single conductors or multi-core cables to be secured in different ways. The width of the cable ties must correspond to the hole dimensions of the strain relief plates shown above.

Physical data

Width	15 mm / 0.591 inches
Height	3.7 mm / 0.146 inches
Depth	56.5 mm / 2.224 inches

Mechanical data

Suitable	for standard male and female connectors
----------	---

Material data

Note (material data)	Information on material specifications can be found here
Color	light gray
Material group	I
Insulation material (main housing)	Polyamide (PA66)
Flammability class per UL94	V0
Fire load	0.038 MJ
Weight	1.3 g

Commercial data

PU (SPU)	96 (24) pcs
Packaging type	Box
Country of origin	DE
GTIN	4055143368698
Customs tariff number	85389099990

Product Classification

UNSPSC	39121421
eCl@ss 10.0	27-14-11-92
eCl@ss 9.0	27-14-11-92
ETIM 9.0	EC002848
ETIM 10.0	EC002848
ECCN	NO US CLASSIFICATION

Environmental Product Compliance

RoHS Compliance Status	Compliant, No Exemption
------------------------	-------------------------

Downloads

Environmental Product Compliance

Compliance Search

Environmental Product
Compliance 831-503



Documentation

Additional Information

Technical Section	03.04.2019	pdf 2027.26 KB	↓
-------------------	------------	-------------------	-------------------

CAD/CAE-Data

CAD data

2D/3D Models 831-503	↓
----------------------	-------------------

CAE data

ZUKEN Portal 831-503	↓
----------------------	-------------------

Installation Notes

Installation

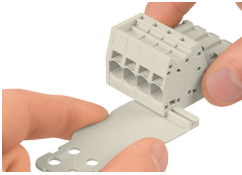

Strain relief plate, for field assembly

Application

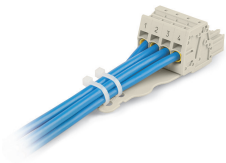

Strain relief plate, for factory assembly
1-conductor female conductor, 4-pole,
7.62 mm pin spacing, light gray
(831-3104/135-000)