

28 677 970 Product version from 4/1/2025















- rain shower Ø 300 mm
- Rain shower material: metal
- PURE RAIN, max. flow rate 14 l/min (at 3 bar)
- Function from: 10 l/min
- quick clearing
- with anti-scale system

Technical data:

- 450mm projection
- rosette Ø 60 mm
- 1/2" connection

Notes:

	Brushed Dark Bronze (PVD)	28 677 970-43
	Chrome	28 677 970-00
	Brushed Platinum	28 677 970-06
	Platinum	28 677 970-08
	Dark Chrome	28 677 970-19
	Light Gold (PVD)	28 677 970-26
	Brushed Light Gold (PVD)	28 677 970-27
	Brushed Durabronze (23kt Gold)	28 677 970-28
	Matte Black	28 677 970-33
	Brushed Gold (PVD)	28 677 970-37
	Brushed Dark Brass (PVD)	28 677 970-39
	Brushed Bronze (PVD)	28 677 970-42
	Brushed Champagne (22kt Gold)	28 677 970-46
	Champagne (22kt Gold)	28 677 970-47
	Brushed Chrome	28 677 970-93
	Brushed Dark Platinum	28 677 970-99

Recommended miscellaneous



- Concealed wall elbow -** 35 085 970 90
- min. recess depth 90 mm
 - max. recess depth 163 mm

28 677 970 Product version from 4/1/2025

mm [inches]

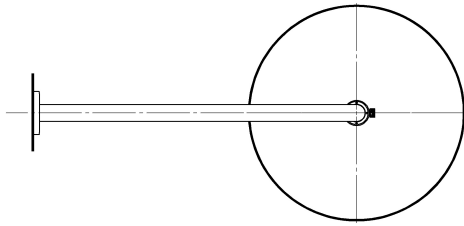
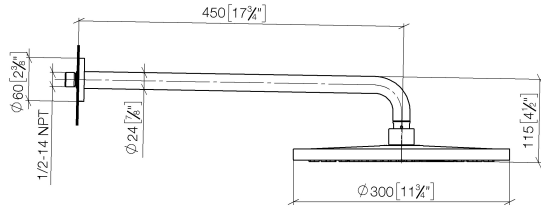

Flow rate chart

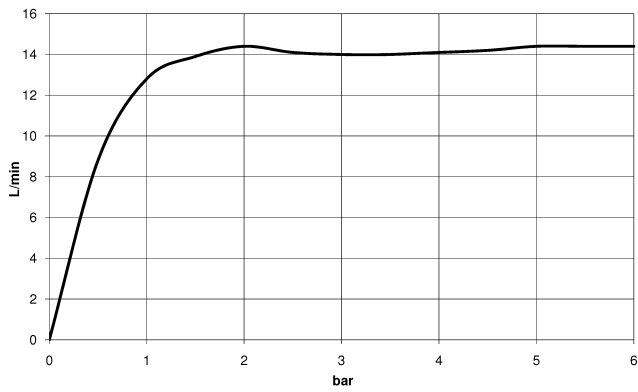

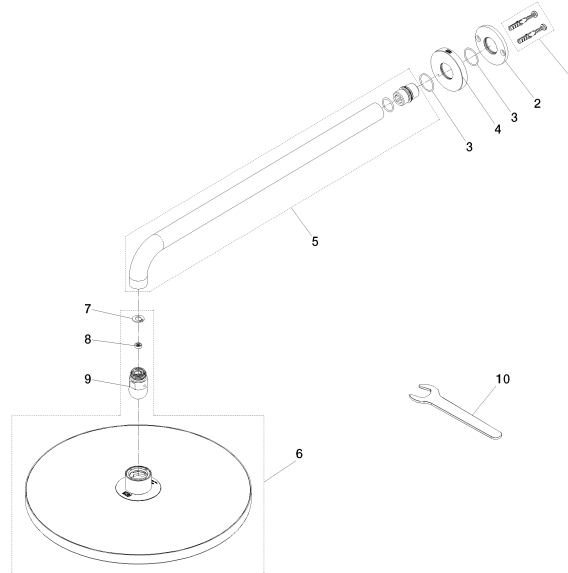

Spare parts list

No.	Item Number	Name	Quantity used	Delivery time
2	09 17 20 120 90	Connection Ø 56,50 x 5 mm -	1.00	14
6	90 12 05 096 00-43	Rainshower round Ø 300 mm - Brushed Dark Bronze (PVD)	1.00	40
10	90 30 09 069 00 90	Spanner -	1.00	14
4	09 27 97 015-43	rosette	1.00	82
9	90 18 40 278 00 90	Tube aerator Ø 14 x 37,5 mm, 7 l/min. -	1.00	14
8	09 23 01 101 90	Flow limiter pink 14 l/min. -	1.00	14
7	09 16 01 014 90	Ring Retaining ring Ø 15 x 1 mm -	1.00	14
5	90 11 03 070 00-43	pipe	1.00	40
1	04 30 31 032 00 90	Attachment set Bolt 4 x 35 mm -	1.00	14
3	09 14 10 150 90	O-Ring 23 x 1,5 mm -	2.00	14