







Handle for sink unit - Brushed Bronze (PVD)

SPARE PARTS

90 20 80 036 00



	Brushed Bronze (PVD)	90 20 80 036 00-42
	Chrome	90 20 80 036 00-00
	Brushed Platinum	90 20 80 036 00-06
	Platinum	90 20 80 036 00-08
	Durabronze (23kt Gold)	90 20 80 036 00-09
	Dark Chrome	90 20 80 036 00-19
	Brushed Durabronze (23kt Gold)	90 20 80 036 00-28
	Matte Black	90 20 80 036 00-33
	Brushed Champagne (22kt Gold)	90 20 80 036 00-46
	Champagne (22kt Gold)	90 20 80 036 00-47
	Brushed Chrome	90 20 80 036 00-93
	Brushed Dark Platinum	90 20 80 036 00-99



Handle for sink unit - Brushed Bronze (PVD)

SPARE PARTS

90 20 80 036 00



Handle for sink unit - Brushed Bronze (PVD)

SPARE PARTS

90 20 80 036 00

90 20 80 036 00

Parts for other finishes can be found here: [Chrome](#)

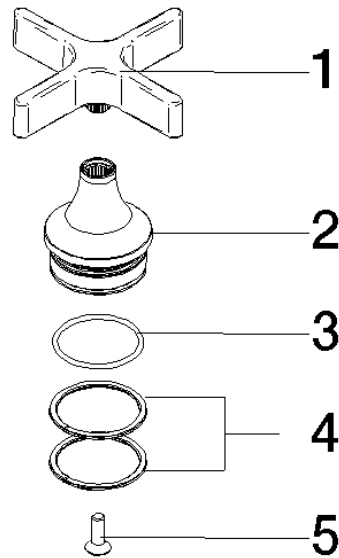

Spare parts list

No.	Item Number	Name	Quantity used	Delivery time
3	09 14 10 019 90	O-Ring EPDM 70 25,0 x 1,5 mm -	1.00	14
5	90 30 30 014 00 90	Mounting Countersunk screw with hexagon socket M4 x 12 mm -	1.00	14
1	90 20 80 036 10-42	Handle Neutral - Brushed Bronze (PVD)	1.00	40
2	90 12 12 231 00-42	Retainer - Brushed Bronze (PVD)	1.00	40
4	90 14 15 072 00 90	Slip ring -	2.00	14