

Productinformatieblad

Specificaties



black toggle switch head Ø22 2-position return cp grey

ZB5AD48C0

EAN Code: 3606489763442

Prijs: 17,25 EUR

Hoofd

| | |
|------------------------------------|--------------------------|
| range of product | Harmony XB5 |
| product of component type | Kop voor keuzeschakelaar |
| device short name | ZB5 |
| kraag materiaal | Kunststof gekleurd grijs |
| bevestigingsdiameter | 22 mm |
| verkoop per ondeelbare hoeveelheid | 1 |
| koptype | Standaard |
| vorm van kop signaleringseenheid | Rond |
| type operator | terugverend |
| operator profiel | Zwart toggle switch |
| extra informatie operator | Zwarte hefboom |
| informatie positie operator | 2 standen 90° |

Complementair

| | |
|--------------------------------|---|
| CAD totale breedte | 29 mm |
| CAD totale hoogte | 29 mm |
| CAD totale diepte | 45 mm |
| gewicht product | 0,023 kg |
| mechanical durability | 500000 cycles |
| naam station | XALD 1...5 uitsnijdingen XALK 2...5 uitsnijdingen |
| elektrische samenstellingscode | C11 voor <3 contacten gebruik enkelvoudig blokken in vooraan gemonteerd C12 voor <6 contacten gebruik enkelvoudig blokken in vooraan gemonteerd C15 voor <1 contacten gebruik enkelvoudig blokken in vooraan gemonteerd SF1 voor <3 contacten gebruik enkelvoudig blokken in vooraan gemonteerd SR1 voor <3 contacten gebruik enkelvoudig blokken in montage aan achterzijde C13 voor <6 contacten gebruik enkelvoudig en dubbel blokken in vooraan gemonteerd |
| product presentatie | Basisonderdeel |

Omgeving

| | |
|-------------------------------------|--|
| beschermende behandeling | TH |
| ambient air temperature for storage | -40...70 °C |
| omgevingstemperatuur voor werking | -40...70 °C |
| overvoltage category | Klasse II In overeenstemming met IEC 60536 |

De weergegeven prijs is de adviesprijs in euro excl. BTW. Deze kan onderhevig zijn aan korting. Neem contact op met uw lokale distributeur of detailhandel voor de daadwerkelijke prijs

| | |
|-------------------------------------|--|
| IP beschermingsgraad | IP66 In overeenstemming met IEC 60529 |
| Enclosure Type | UL type 4X/13 |
| weerstand hoge druk drukring | 7000000 Pa om 55 °C, afstand: 0.1 m |
| IK beschermingsgraad | IK06 |
| standards | UL 508 IEC 60947-5-4 IEC 60947-5-1 JIS C8201-5-1 CSA C22.2 Nr 14 IEC 60947-1 JIS C8201-1 |
| product certifications | DNV UL listed LROS (Lloyds register of shipping) BV CSA |
| trilling bestendigheid | 5 gn (f= 2...500 Hz) In overeenstemming met IEC 60068-2-6 |
| schokbestendigheid | 30 gn (duur = 18 ms) voor halve sinusgolf versnelling In overeenstemming met IEC 60068-2-27 50 gn (duur = 11 ms) voor halve sinusgolf versnelling In overeenstemming met IEC 60068-2-27 |

Verpakkingseenheid

| | |
|--|----------|
| Eenheidstype van verpakking 1 | PCE |
| Aantal eenheden in verpakking 1 | 1 |
| verpakking 1 hoogte | 3,400 cm |
| verpakking 1 breedte | 4,500 cm |
| verpakking 1 lengte | 5,300 cm |
| verpakking_1_gewicht | 20,000 g |

contractuele waarborg

| | |
|------------------------------|----|
| Garantie (in maanden) | 18 |
|------------------------------|----|

Schneider Electric wil tegen 2050 de Net Zero-status hebben bereikt via partnerschappen in de toeleveringsketen, materialen met een lagere impact en circulariteit via onze doorlopende campagne "Use Better, Use Longer, Use Again" om de levensduur van producten en de recycleerbaarheid te verlengen.

[Uitleg van Environmental Data >](#)

[Hoe evalueren we de duurzaamheid van producten? >](#)

Milieuoetafdruk

Milieu Profiel

[Milieuprofiel van het product](#)

Use Better

Materialen en verpakking

Pakket met gerecycleerd karton

Ja

Verpakkingen zonder kunststof

Ja

RoHS-richtlijn van de EU

[Conform](#)

REACH-verordening

[Referentie bevat geen SVHC boven drempelwaarde](#)

Use Longer

Levensduurverlenging

Reparatie

Nee

Use Again

Herverpakken en herfabriceren

Circulair Profiel

[Informatie over einde levensduur](#)

Terugname

Ja

Dimensions Drawings

Dimensions

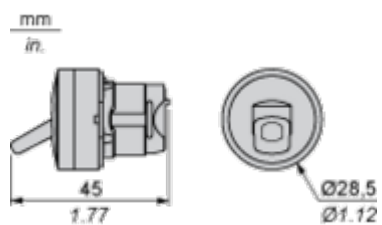

Mounting and Clearance

Panel Cut-out for Pushbuttons, Switches and Pilot Lights (Finished Holes, Ready for Installation)

Connection by Screw Clamp Terminals or Plug-in Connectors or on Printed Circuit Board



- (1) Diameter on finished panel or support
- (2) For selector switches and Emergency stop buttons, use of an anti-rotation plate type ZB5AZ902 is recommended.
- (3) Ø22.5 mm recommended ($\text{Ø}22.3 \text{ }_0^{+0.4}$) / Ø0.89 in. recommended ($\text{Ø}0.88 \text{ in. }_0^{+0.016}$)

| Connections | a in mm | a in in. | b in mm | b in in. |
|---|---------|----------|---------|----------|
| By screw clamp terminals or plug-in connector | 40 | 1.57 | 30 | 1.18 |
| By Faston connectors | 45 | 1.77 | 32 | 1.26 |
| On printed circuit board | 30 | 1.18 | 30 | 1.18 |

Detail of Lug Recess

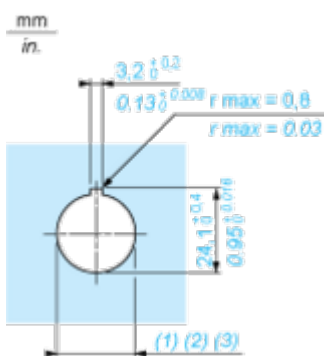

- (1) Diameter on finished panel or support
- (2) For selector switches and Emergency stop buttons, use of an anti-rotation plate type ZB5AZ902 is recommended.
- (3) Ø22.5 mm recommended ($\text{Ø}22.3 \text{ }_0^{+0.4}$) / Ø0.89 in. recommended ($\text{Ø}0.88 \text{ in. }_0^{+0.016}$)

Pushbuttons, Switches and Pilot Lights for Printed Circuit Board Connection

Panel Cut-outs (Viewed from Installer's Side)



A: 30 mm min. / 1.18 in. min.

B: 40 mm min. / 1.57 in. min.

Printed Circuit Board Cut-outs (Viewed from Electrical Block Side)

Dimensions in mm



A: 30 mm min.

B: 40 mm min.

Dimensions in in.



A: 1.18 in. min.
 B: 1.57 in. min.

General Tolerances of the Panel and Printed Circuit Board

The cumulative tolerance must not exceed 0.3 mm / 0.012 in.: T1 + T2 = 0.3 mm max.

Installation Precautions

- Minimum thickness of circuit board: 1.6 mm / 0.06 in.
- Cut-out diameter: 22.4 mm ± 0.1 / 0.88 in. ± 0.004
- Orientation of body/fixing collar ZB5AZ009: ± 2° 30' (excluding cut-outs marked a and b).
- Tightening torque of screws ZBZ006: 0.6 N.m (5.3 lbf.in) max.
- Allow for one ZB5AZ079 fixing collar/pillar and its fixing screws:
 - every 90 mm / 3.54 in. horizontally (X), and 120 mm / 4.72 in. vertically (Y).
 - with each selector switch head (ZB5AD*, ZB5AJ*, ZB5AG*).

The fixing centers marked a and b are diagonally opposed and must align with those marked 4 and 5.



- (1) Head ZB5AD•
- (2) Panel
- (2) Nut
- (4) Printed circuit board

Mounting of Adapter (Socket) ZBZ01•

- 1 2 elongated holes for ZBZ006 screw access
- 2 1 hole \varnothing 2.4 mm \pm 0.05 / 0.09 in. \pm 0.002 for centring adapter ZBZ01•
- 3 8 \times \varnothing 1.2 mm / 0.05 in. holes
- 4 1 hole \varnothing 2.9 mm \pm 0.05 / 0.11 in. \pm 0.002, for aligning the printed circuit board (with cut-out marked **a**)
- 5 1 elongated hole for aligning the printed circuit board (with cut-out marked **b**)
- 6 4 holes \varnothing 2.4 mm / 0.09 in. for clipping in adapter ZBZ01•

Dimensions An + 18.1 relate to the \varnothing 2.4 mm \pm 0.05 / 0.09 in. \pm 0.002 holes for centring adapter ZBZ01•.

Technical Description

Electrical Composition Corresponding to Codes C9, C11, SF1 and SR1

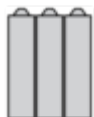

Electrical Composition Corresponding to Code C15

1 N/O

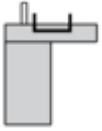

1 N/C



1 N/O + N/C or 1 N/O + N/O or 1 N/C + N/C



Electrical Composition Corresponding to Code C12

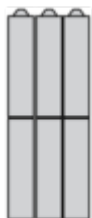

Electrical Composition Corresponding to Code C13



Legend

Single contact



Double contact



Light block



Possible location



Technical Illustration

Dimensions

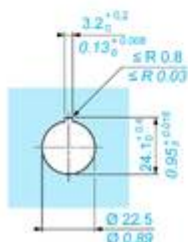
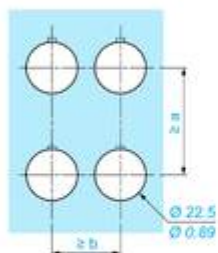
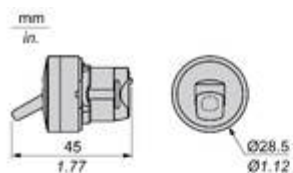

| | | a (mm) | a (in.) | b (mm) | b (in.) |
|-----------|-----------|--------|---------|--------|---------|
| | | 40 | 1.57 | 30 | 1.18 |
| ZBE●●●●● | ZBV●●●●● | | | | |
| | | 45 | 1.77 | 32 | 1.26 |
| ZBE●●●●●3 | ZBV●●●●●3 | | | | |
| | | 40 | 1.57 | 30 | 1.18 |
| ZBE●●●●●4 | ZBV●●●●●4 | | | | |
| | | 50 | 1.97 | 30 | 1.18 |
| ZBE●●●●●5 | ZBV●●●●●5 | | | | |
| | | 40 | 1.57 | 30 | 1.18 |
| ZBE●●●●●9 | ZBV●●●●●9 | | | | |
| | | 40 | 1.57 | 30 | 1.18 |
| ZBRT● | ZBRV1 | | | | |