

36 514 979 Product version from 4/1/2024



















- AQUAPRESSURE FLOW, max. flow rate 10 l/min (at 3 bar)
- water jet adjustable
- Function from: 5.7 l/min
- with anti-scale system

Technical data:

- cover plate 120 x 60 mm
- 1/2" connection

Notes:

- This product can help a building meet the requirements of Green Building Rating Systems, e.g. LEED®, BREEAM®, DGNB

	Platinum	36 514 979-08
	Chrome	36 514 979-00
	Brushed Platinum	36 514 979-06
	Dark Chrome	36 514 979-19
	Light Gold (PVD)	36 514 979-26
	Brushed Light Gold (PVD)	36 514 979-27
	Brushed Durabrass (23kt Gold)	36 514 979-28
	Matte Black	36 514 979-33
	Brushed Gold (PVD)	36 514 979-37
	Brushed Dark Brass (PVD)	36 514 979-39
	Brushed Bronze (PVD)	36 514 979-42
	Brushed Dark Bronze (PVD)	36 514 979-43
	Brushed Champagne (22kt Gold)	36 514 979-46
	Champagne (22kt Gold)	36 514 979-47
	Brushed Chrome	36 514 979-93
	Brushed Dark Platinum	36 514 979-99

Recommended miscellaneous



- Concealed wall elbow -** 35 085 970 90
- min. recess depth 90 mm
 - max. recess depth 163 mm

36 514 979 Product version from 4/1/2024

mm [inches]

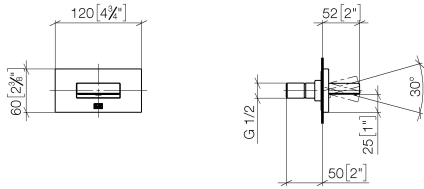

Flow rate chart



Trajectory diagram

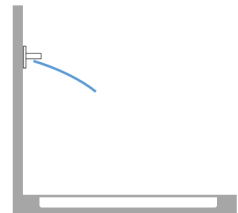
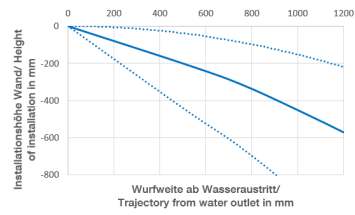

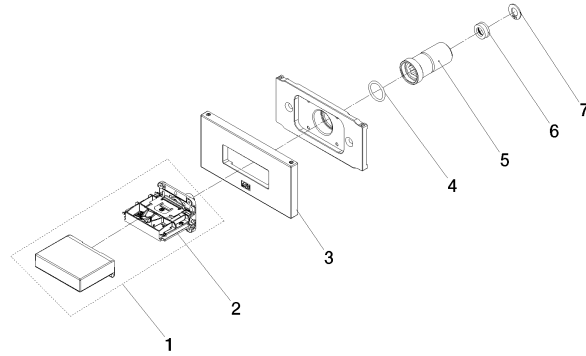

Spare parts list

No.	Item Number	Name	Quantity used	Delivery time
1	90 17 01 230 00-08	Housing for Water Curve - Platinum	1.00	54
5	09 24 04 336 90	Nipple for Water Curve Ø 25 x 49 mm -	1.00	14
7	09 16 01 014 90	Ring Retaining ring Ø 15 x 1 mm -	1.00	14
6	09 23 01 134 90	Flow limiter grey 9,5 l/min. -	1.00	14
2	90 29 03 088 00 90	Aerator 55 x 39 x 56 mm -	1.00	14
3	90 27 97 041 00-08	Rosette 120 x 60 x 9 mm - Platinum	1.00	54
4	90 14 10 010 00 90	O-Ring EPDM 70 17,0 x 2,0 mm -	1.00	14