

Data Sheet | Item Number: 2002-1671/401-000

2-conductor disconnect/test terminal block; with mechanical interlock; with test option; orange disconnect link; for DIN-rail 35 x 15 and 35 x 7.5; 2.5 mm²; Push-in CAGE CLAMP®; 2,50 mm²; gray

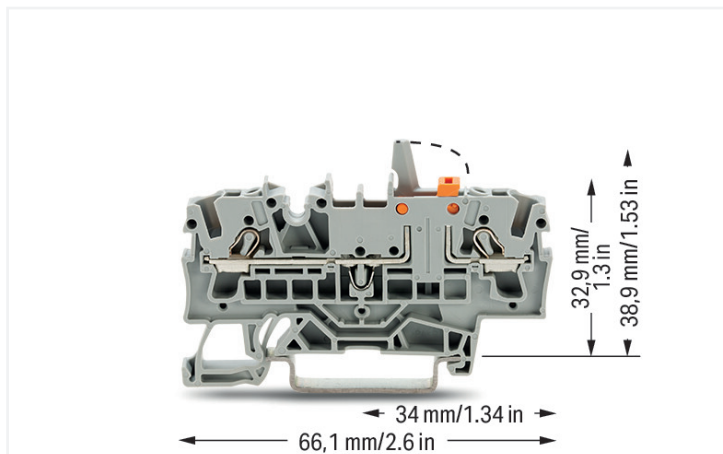

<https://www.wago.com/2002-1671/401-000>



Color: ■ gray

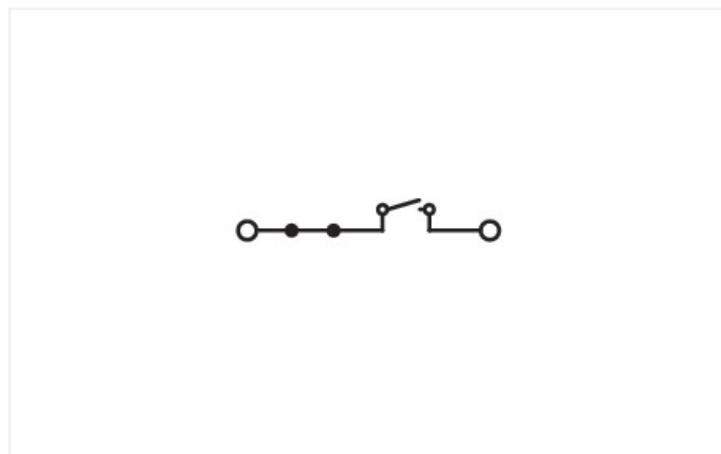
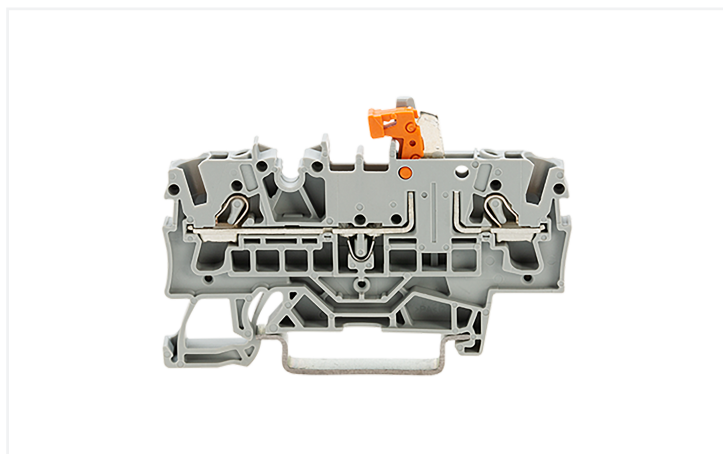

Similar to illustration

Disconnect terminal block for test and measurement, 2002 Series, gray

Error-free electrical installations are guaranteed with this disconnect terminal block for test and measurement (item number 2002-1671/401-000). Ensure that the strip lengths are between 10 and 12 mm when connecting conductors to this disconnect terminal block for test and measurement. This product features conductor terminals and utilizes Push-in CAGE CLAMP®. Our Push-in CAGE CLAMP® is a universal, maintenance-free connection solution for all conductor types, offering a key advantage: It allows direct insertion of both solid and fine-stranded conductors with ferrules without needing tools. No preparation is required; for example, crimping the conductor's ferrule is not necessary. This disconnect terminal block for test and measurement is suitable for conductor cross sections ranging from 0.25 mm² to 4 mm².

This product is designed for specific Ex applications (please refer to the product datasheet).

Notes

Safety Information

The 2 mm test slot is only approved for high impedance measurement up to max. 100 mA.

Electrical data

Ratings per	IEC/EN 60947-7-1		
Overvoltage category	III	III	II
Pollution degree	3	2	2
Nominal voltage	400 V	-	-
Rated impulse withstand voltage	6 kV	-	-
Rated current	16 A	-	-

Approvals per	CSA 22.2 No 158		
Use group	B	C	D
Rated voltage	300 V	300 V	-
Rated current	10 A	10 A	-

Power Loss

Power loss, per pole (potential)	0.3405 W
Rated current I_N for power loss specification	16 A
Resistance value for specified, current-dependent power loss	0.00133 Ω

Approvals per	UL 1059		
Use group	B	C	D
Rated voltage	300 V	300 V	-
Rated current	15 A	15 A	-

Ex information

Reference to hazardous areas	See "Downloads – Documentation – Additional Information: Technical Section; Technical Explanations"
Ratings per	ATEX: KIWA 17 ATEX 0030 U / IECEx: KIWA 17.0014U (Ex ec IIC Gc)
Rated voltage EN (Ex e II)	440 V
Rated current (Ex e II)	17 A

General information

Wiring direction	Front-entry wiring
------------------	--------------------

Connection Data

Clamping units	2
Total number of potentials	2
Number of levels	1
Number of jumper slots	2

Connection 1

Connection technology	Push-in CAGE CLAMP®
Actuation type	Operating tool
Connectable conductor materials	Copper
Nominal cross-section	2.5 mm ²
Solid conductor	0.25 ... 4 mm ² / 22 ... 12 AWG
Solid conductor; push-in termination	0.75 ... 4 mm ² / 18 ... 12 AWG
Fine-stranded conductor	0.25 ... 4 mm ² / 22 ... 12 AWG
Fine-stranded conductor; with insulated ferrule	0.25 ... 2.5 mm ² / 22 ... 14 AWG
Fine-stranded conductor; with ferrule; push-in termination	1 ... 2.5 mm ² / 18 ... 14 AWG
Note (conductor cross-section)	Depending on the conductor characteristic, a conductor with a smaller cross-section can also be inserted via push-in termination.
Strip length	10 ... 12 mm / 0.39 ... 0.47 inches
Wiring direction	Front-entry wiring

Physical data

Width	5.2 mm / 0.205 inches
Height	66.1 mm / 2.602 inches
Depth from upper-edge of DIN-rail	32.9 mm / 1.295 inches

Mechanical data

Mounting type	DIN-35 rail
Marking level	Center/side marking

Material data

Note (material data)	Information on material specifications can be found here
Color	gray
Material group	I
Insulation material (main housing)	Polyamide (PA66)
Flammability class per UL94	V0
Fire load	0.157 MJ
Weight	7.5 g

Environmental requirements

Processing temperature	-35 ... +85 °C
Continuous operating temperature	-60 ... +105 °C

Environmental Testing

Test specification: Railway applications – Rolling stock – Electronic equipment	DIN EN 50155 (VDE 0115-200):2022-06
Test procedure: Railway applications – Rolling stock equipment – Vibration and shock tests	DIN EN 61373 (VDE 0115-0106):2011-04
Spectrum/Mounting location	Service life test, Category 1, Class A/B
Functional test with noise-like oscillations	Test passed according to Section 8 of the standard
Frequency	$f_1 = 5 \text{ Hz}$ to $f_2 = 150 \text{ Hz}$
Acceleration	0.101g (highest test level used for all axes)
Test duration per axis	10 min.
Test directions	X, Y and Z axes
Monitoring of contact faults and interruptions	Passed
Voltage drop measurement before and after each axis	Passed
Simulated service life test through increased levels of noise-like oscillations	Test passed according to Section 9 of the standard
Frequency	$f_1 = 5 \text{ Hz}$ to $f_2 = 150 \text{ Hz}$
Acceleration	0.572g (highest test level used for all axes)
Test duration per axis	5 h
Test directions	X, Y and Z axes
Extended testing: Monitoring of contact faults and interruptions	Passed
Extended testing: Voltage drop measurement before and after each axis	Passed
Shock test	Test passed according to Section 10 of the standard
Shock pulse form	Half sine
Acceleration	5g (highest test level used for all axes)
Shock duration	30 ms
Number of shocks (per axis)	3 pos. und 3 neg.
Test directions	X, Y and Z axes

Environmental Testing

Extended testing: Monitoring of contact faults and interruptions	Passed
Extended testing: Voltage drop measurement before and after each axis	Passed
Vibration and shock stress for rolling stock equipment	Passed

Commercial data

Product Group	22 (TOPJOB S)
PU (SPU)	50 pcs
Packaging type	Box
Country of origin	CN
GTIN	4055143874502
Customs tariff number	85365080000

Product Classification

UNSPSC	39121410
eCl@ss 10.0	27-14-11-26
eCl@ss 9.0	27-14-11-26
ETIM 9.0	EC000902
ETIM 10.0	EC000902
ECCN	NO US CLASSIFICATION

Environmental Product Compliance

RoHS Compliance Status	Compliant, No Exemption
------------------------	-------------------------

Approvals / Certificates

General approvals



Approval	Standard	Certificate Name
CCA DEKRA Certification B.V.	EN 60947	NTR NL-8054
DEKRA DEKRA Certification B.V.	EN 60947	71-149763
KEMA/KEUR DEKRA Certification B.V.	EN 60947	71-124163
UL Underwriters Laboratories Inc.	UL 1059	E45172

Declarations of conformity and manufacturer's declarations



Approval	Standard	Certificate Name
ATEX-Attestation of Conformity WAGO GmbH & Co. KG	-	-
ATEX-Attestation of Conformity WAGO GmbH & Co. KG	-	-
EU-Declaration of Conformity WAGO GmbH & Co. KG	-	-
Railway WAGO GmbH & Co. KG	-	Railway Ready
UK-Declaration of Conformity WAGO GmbH & Co. KG	-	-

Approvals for marine applications



Approval	Standard	Certificate Name
ABS American Bureau of Ship- ping	EN 60947	24-0152298-PDA
DNV GL Det Norske Veritas, Ger- manischer Lloyd	-	TAE00001V2
PRS Polski Rejestr Statków	-	TE/1094/880590/23

Approvals for hazardous areas



Approval	Standard	Certificate Name
AEx Underwriters Laboratories Inc.	UL 60079	E185892 (AEx eb IIC resp. Ex eb IIC)
ATEX KIWA Netherlands B.V.	EN 60079	KIWA 17ATEX0030 U
CCC CNEX	GB/T 3836.3	2020312313000180 (Ex ec IIC Gc)
IECEx KIWA Netherlands B.V.	EN 60079	IECEx KIWA 17.0014U (Ex ec IIC Gc)

Downloads

Environmental Product Compliance

Compliance Search	
Environmental Product Compliance 2002-1671/401-000	↓

Documentation

Bid Text			
2002-1671/401-000	29.04.2019	xml 4.04 KB	↓
2002-1671/401-000	23.04.2019	docx 15.34 KB	↓

CAD/CAE-Data

CAD data	
2D/3D Models 2002-1671/401-000	↓

CAE data	
EPLAN Data Portal 2002-1671/401-000	↓
WSCAD Universe 2002-1671/401-000	↓
ZUKEN Portal 2002-1671/401-000	↓

1 Compatible Products

1.1 Required Accessories

1.1.1 End plate

1.1.1.1 End plate



Item No.: 2002-1691

End and intermediate plate; 1 mm thick; gray

Item No.: 2002-1692

End and intermediate plate; 1 mm thick; orange

1.2 Optional Accessories

1.2.1 DIN-rail

1.2.1.1 Mounting accessories



Item No.: 210-196

Aluminum carrier rail; 35 x 8.2 mm; 1.6 mm thick; 2 m long; unslotted; similar to EN 60715; silver-colored



Item No.: 210-198

Copper carrier rail; 35 x 15 mm; 2.3 mm thick; 2 m long; unslotted; according to EN 60715; copper-colored



Item No.: 210-508

Steel carrier rail; 35 x 15 mm; 1.5 mm thick; 2 m long; slotted; galvanized; similar to EN 60715; silver-colored



Item No.: 210-197

Steel carrier rail; 35 x 15 mm; 1.5 mm thick; 2 m long; slotted; similar to EN 60715; silver-colored



Item No.: 210-506

Steel carrier rail; 35 x 15 mm; 1.5 mm thick; 2 m long; unslotted; galvanized; similar to EN 60715; silver-colored



Item No.: 210-114

Steel carrier rail; 35 x 15 mm; 1.5 mm thick; 2 m long; unslotted; similar to EN 60715; silver-colored



Item No.: 210-118

Steel carrier rail; 35 x 15 mm; 2.3 mm thick; 2 m long; unslotted; according to EN 60715; silver-colored



Item No.: 210-115

Steel carrier rail; 35 x 7.5 mm; 1 mm thick; 2 m long; slotted; according to EN 60715; "Hole width 18 mm; silver-colored



Item No.: 210-112

Steel carrier rail; 35 x 7.5 mm; 1 mm thick; 2 m long; slotted; according to EN 60715; "Hole width 25 mm; silver-colored



Item No.: 210-504

Steel carrier rail; 35 x 7.5 mm; 1 mm thick; 2 m long; slotted; galvanized; according to EN 60715; silver-colored



Item No.: 210-113

Steel carrier rail; 35 x 7.5 mm; 1 mm thick; 2 m long; unslotted; according to EN 60715; silver-colored



Item No.: 210-505

Steel carrier rail; 35 x 7.5 mm; 1 mm thick; 2 m long; unslotted; galvanized; according to EN 60715; silver-colored

1.2.2 Ferrule

1.2.2.1 Ferrule



Item No.: 216-241

Ferrule; Sleeve for 0.5 mm² / 20 AWG; insulated; electro-tin plated; electrolytic copper; gastight crimped; acc. to DIN 46228, Part 4/09.90; white



Item No.: 216-242

Ferrule; Sleeve for 0.75 mm² / 18 AWG; insulated; electro-tin plated; electrolytic copper; gastight crimped; acc. to DIN 46228, Part 4/09.90; gray



Item No.: 216-262

Ferrule; Sleeve for 0.75 mm² / 18 AWG; insulated; electro-tin plated; electrolytic copper; gastight crimped; acc. to DIN 46228, Part 4/09.90; gray



Item No.: 216-243

Ferrule; Sleeve for 1 mm² / AWG 18; insulated; electro-tin plated; electrolytic copper; gastight crimped; acc. to DIN 46228, Part 4/09.90; red



Item No.: 216-263

Ferrule; Sleeve for 1 mm² / AWG 18; insulated; electro-tin plated; electrolytic copper; gastight crimped; acc. to DIN 46228, Part 4/09.90; red



Item No.: 216-244

Ferrule; Sleeve for 1.5 mm² / AWG 16; insulated; electro-tin plated; electrolytic copper; gastight crimped; acc. to DIN 46228, Part 4/09.90; black



Item No.: 216-264

Ferrule; Sleeve for 1.5 mm² / AWG 16; insulated; electro-tin plated; electrolytic copper; gastight crimped; acc. to DIN 46228, Part 4/09.90; black



Item No.: 216-246

Ferrule; Sleeve for 2.5 mm² / AWG 14; insulated; electro-tin plated; electrolytic copper; gastight crimped; acc. to DIN 46228, Part 4/09.90; blue



Item No.: 216-266

Ferrule; Sleeve for 2.5 mm² / AWG 14; insulated; electro-tin plated; electrolytic copper; gastight crimped; acc. to DIN 46228, Part 4/09.90; blue

1.2.3 Installation

1.2.3.1 Cover



Item No.: 709-156

Cover; Type 3; suitable for cover carrier, type 3; 1 m long; transparent

1.2.3.2 Cover carrier



Item No.: 709-169

Cover carrier; Type 3; incl. fixing/retaining screws and knurled nut; suitable for 279 to 282 and 880 Series rail-mounted terminal blocks; suitable for 264 Series miniature rail-mounted terminal blocks; suitable for 270 Series sensor and actuator terminal blocks; gray

1.2.4 Insulation stop

1.2.4.1 Insulation stop



Item No.: 2002-171

Insulation stop; 0.25 - 0.5 mm²; 5 pieces/strip; light gray



Item No.: 2002-172

Insulation stop; 0.75 - 1 mm²; 5 pieces/strip; dark gray

1.2.5 Jumper

1.2.5.1 Jumper



Item No.: 2002-400

Continuous jumper; 2-way; insulated; light gray



Item No.: 2002-413

Continuous jumper; 3-way; insulated; light gray



Item No.: 2002-415

Continuous jumper; 5-way; insulated; light gray



Item No.: 2002-423/000-006

Continuous jumper; from 1 to 3; insulated; blue



Item No.: 2002-423

Continuous jumper; from 1 to 3; insulated; light gray



Item No.: 2002-423/000-005

Continuous jumper; from 1 to 3; insulated; red



Item No.: 2002-424/000-006

Continuous jumper; from 1 to 4; insulated; blue



Item No.: 2002-424

Continuous jumper; from 1 to 4; insulated; light gray



Item No.: 2002-424/000-005

Continuous jumper; from 1 to 4; insulated; red



Item No.: 2002-406/020-000

Delta jumper; insulated; light gray



Item No.: 2002-410/000-006

Jumper; 10-way; insulated; blue



Item No.: 2002-410

Jumper; 10-way; insulated; light gray



Item No.: 2002-410/000-005

Jumper; 10-way; insulated; red



Item No.: 2002-402/000-006

Jumper; 2-way; insulated; blue



Item No.: 2002-402

Jumper; 2-way; insulated; light gray



Item No.: 2002-402/000-005

Jumper; 2-way; insulated; red



Item No.: 2002-403/000-006

Jumper; 3-way; insulated; blue



Item No.: 2002-403

Jumper; 3-way; insulated; light gray



Item No.: 2002-403/000-005

Jumper; 3-way; insulated; red



Item No.: 2002-404/000-006

Jumper; 4-way; insulated; blue



Item No.: 2002-404

Jumper; 4-way; insulated; light gray



Item No.: 2002-404/000-005

Jumper; 4-way; insulated; red



Item No.: 2002-405/000-006























Jumper; 5-way; insulated; blue



Item No.: 2002-405



Jumper; 5-way; insulated; light gray

1.2.5.1 Jumper

 Item No.: 2002-405/000-005 Jumper; 5-way; insulated; red	 Item No.: 2002-406/000-006 Jumper; 6-way; insulated; blue	 Item No.: 2002-406 Jumper; 6-way; insulated; light gray	 Item No.: 2002-406/000-005 Jumper; 6-way; insulated; red
 Item No.: 2002-407/000-006 Jumper; 7-way; insulated; blue	 Item No.: 2002-407 Jumper; 7-way; insulated; light gray	 Item No.: 2002-407/000-005 Jumper; 7-way; insulated; red	 Item No.: 2002-408/000-006 Jumper; 8-way; insulated; blue
 Item No.: 2002-408 Jumper; 8-way; insulated; light gray	 Item No.: 2002-408/000-005 Jumper; 8-way; insulated; red	 Item No.: 2002-409/000-006 Jumper; 9-way; insulated; blue	 Item No.: 2002-409 Jumper; 9-way; insulated; light gray
 Item No.: 2002-409/000-005 Jumper; 9-way; insulated; red	 Item No.: 2002-440 Jumper; from 1 to 10; insulated; light gray	 Item No.: 2002-433 Jumper; from 1 to 3; insulated; light gray	 Item No.: 2002-434 Jumper; from 1 to 4; insulated; light gray
 Item No.: 2002-435 Jumper; from 1 to 5; insulated; light gray	 Item No.: 2002-436 Jumper; from 1 to 6; insulated; light gray	 Item No.: 2002-437 Jumper; from 1 to 7; insulated; light gray	 Item No.: 2002-438 Jumper; from 1 to 8; insulated; light gray
 Item No.: 2002-439 Jumper; from 1 to 9; insulated; light gray	 Item No.: 2002-480 Staggered jumper; 10-way; insulated; light gray	 Item No.: 2002-481 Staggered jumper; 11-way; insulated; light gray	 Item No.: 2002-482 Staggered jumper; 12-way; insulated; light gray
 Item No.: 2002-473/011-000 Staggered jumper; 2-way; from 1 to 3; insulated; light gray	 Item No.: 2002-472 Staggered jumper; 2-way; insulated; light gray	 Item No.: 2002-473 Staggered jumper; 3-way; insulated; light gray	 Item No.: 2002-475/011-000 Staggered jumper; 3-way; insulated; light gray
 Item No.: 2002-474 Staggered jumper; 4-way; insulated; light gray	 Item No.: 2002-475 Staggered jumper; 5-way; insulated; light gray	 Item No.: 2002-476 Staggered jumper; 6-way; insulated; light gray	 Item No.: 2002-477 Staggered jumper; 7-way; insulated; light gray
 Item No.: 2002-478 Staggered jumper; 8-way; insulated; light gray	 Item No.: 2002-479 Staggered jumper; 9-way; insulated; light gray	 Item No.: 2002-477/011-000 Staggered jumper; insulated; light gray	 Item No.: 2002-479/011-000 Staggered jumper; insulated; light gray
 Item No.: 2002-481/011-000 Staggered jumper; insulated; light gray	 Item No.: 2002-405/011-000 Star point jumper; 3-way; insulated; light gray	 Item No.: 210-103 Wire commoning chain; insulated; black	 Item No.: 210-123 Wire commoning chain; insulated; blue

1.2.6 Marking

1.2.6.1 Group marker carrier

 Item No.: 2009-191 Group marker carrier; gray	 Item No.: 2009-192 Group marker carrier; gray	 Item No.: 2009-193 Group marker carrier; gray
---	---	--

1.2.6.2 Marker

Item No.: 2009-145/000-006

Mini-WSB Inline; for Smart Printer; 1700 pieces on roll; stretchable 5 - 5.2 mm; plain; snap-on type; blue

Item No.: 2009-145/000-007

Mini-WSB Inline; for Smart Printer; 1700 pieces on roll; stretchable 5 - 5.2 mm; plain; snap-on type; gray

Item No.: 2009-145/000-023

Mini-WSB Inline; for Smart Printer; 1700 pieces on roll; stretchable 5 - 5.2 mm; plain; snap-on type; green

Item No.: 2009-145/000-012

Mini-WSB Inline; for Smart Printer; 1700 pieces on roll; stretchable 5 - 5.2 mm; plain; snap-on type; orange

Item No.: 2009-145/000-005

Mini-WSB Inline; for Smart Printer; 1700 pieces on roll; stretchable 5 - 5.2 mm; plain; snap-on type; red

Item No.: 2009-145/000-024

Mini-WSB Inline; for Smart Printer; 1700 pieces on roll; stretchable 5 - 5.2 mm; plain; snap-on type; violet

Item No.: 2009-145

Mini-WSB Inline; for Smart Printer; 1700 pieces on roll; stretchable 5 - 5.2 mm; plain; snap-on type; white

Item No.: 2009-145/000-002

Mini-WSB Inline; for Smart Printer; 1700 pieces on roll; stretchable 5 - 5.2 mm; plain; snap-on type; yellow



Item No.: 248-501/000-006

Mini-WSB marking card; as card; not stretchable; plain; snap-on type; blue

Item No.: 248-501/000-007

Mini-WSB marking card; as card; not stretchable; plain; snap-on type; gray

Item No.: 248-501/000-023

Mini-WSB marking card; as card; not stretchable; plain; snap-on type; green

Item No.: 248-501/000-017

Mini-WSB marking card; as card; not stretchable; plain; snap-on type; light green



Item No.: 248-501/000-012

Mini-WSB marking card; as card; not stretchable; plain; snap-on type; orange

Item No.: 248-501/000-005

Mini-WSB marking card; as card; not stretchable; plain; snap-on type; red

Item No.: 248-501/000-024

Mini-WSB marking card; as card; not stretchable; plain; snap-on type; violet

Item No.: 248-501

Mini-WSB marking card; as card; not stretchable; plain; snap-on type; white



Item No.: 248-501/000-002

Mini-WSB marking card; as card; not stretchable; plain; snap-on type; yellow

Item No.: 793-5501/000-006

WMB marking card; as card; for terminal block width 5 - 17.5 mm; stretchable 5 - 5.2 mm; plain; snap-on type; blue

Item No.: 793-5501/000-014

WMB marking card; as card; for terminal block width 5 - 17.5 mm; stretchable 5 - 5.2 mm; plain; snap-on type; brown

Item No.: 793-5501/000-007

WMB marking card; as card; for terminal block width 5 - 17.5 mm; stretchable 5 - 5.2 mm; plain; snap-on type; gray



Item No.: 793-5501/000-023

WMB marking card; as card; for terminal block width 5 - 17.5 mm; stretchable 5 - 5.2 mm; plain; snap-on type; green

Item No.: 793-5501/000-017

WMB marking card; as card; for terminal block width 5 - 17.5 mm; stretchable 5 - 5.2 mm; plain; snap-on type; light green

Item No.: 793-5501/000-012

WMB marking card; as card; for terminal block width 5 - 17.5 mm; stretchable 5 - 5.2 mm; plain; snap-on type; orange

Item No.: 793-5501/000-005

WMB marking card; as card; for terminal block width 5 - 17.5 mm; stretchable 5 - 5.2 mm; plain; snap-on type; red



Item No.: 793-5501/000-024

WMB marking card; as card; for terminal block width 5 - 17.5 mm; stretchable 5 - 5.2 mm; plain; snap-on type; violet

Item No.: 793-5501

WMB marking card; as card; for terminal block width 5 - 17.5 mm; stretchable 5 - 5.2 mm; plain; snap-on type; white

Item No.: 793-5501/000-002

WMB marking card; as card; for terminal block width 5 - 17.5 mm; stretchable 5 - 5.2 mm; plain; snap-on type; yellow

Item No.: 2009-115/000-006

WMB-Inline; for Smart Printer; 1500 pieces on roll; stretchable 5 - 5.2 mm; plain; snap-on type; blue



Item No.: 2009-115/000-007

WMB-Inline; for Smart Printer; 1500 pieces on roll; stretchable 5 - 5.2 mm; plain; snap-on type; gray

Item No.: 2009-115/000-023

WMB-Inline; for Smart Printer; 1500 pieces on roll; stretchable 5 - 5.2 mm; plain; snap-on type; green

Item No.: 2009-115/000-017

WMB-Inline; for Smart Printer; 1500 pieces on roll; stretchable 5 - 5.2 mm; plain; snap-on type; light green

Item No.: 2009-115/000-012

WMB-Inline; for Smart Printer; 1500 pieces on roll; stretchable 5 - 5.2 mm; plain; snap-on type; orange



Item No.: 2009-115/000-005

WMB-Inline; for Smart Printer; 1500 pieces on roll; stretchable 5 - 5.2 mm; plain; snap-on type; red

Item No.: 2009-115/000-024

WMB-Inline; for Smart Printer; 1500 pieces on roll; stretchable 5 - 5.2 mm; plain; snap-on type; violet

Item No.: 2009-115

WMB-Inline; for Smart Printer; 1500 pieces on roll; stretchable 5 - 5.2 mm; plain; snap-on type; white

Item No.: 2009-115/000-002

WMB-Inline; for Smart Printer; 1500 pieces on roll; stretchable 5 - 5.2 mm; plain; snap-on type; yellow

1.2.6.3 Marker carrier



Item No.: 2002-121

Adaptor; gray

Item No.: 2002-161

Adaptor; gray

Item No.: 2009-198

Adaptor; gray

1.2.6.4 Marking strip



Item No.: 2009-110

Marking strips; for Smart Printer; on reel; not stretchable; plain; snap-on type; white

1.2.7 Protective warning marker

1.2.7.1 Cover



Item No.: 2002-115

Protective warning marker; for 5 terminal blocks; with high-voltage symbol, black; yellow

1.2.8 Push-in type wire jumper

1.2.8.1 Jumper



Item No.: 2009-414

Push-in type wire jumper; 1.5 mm²; insulated; 110 mm long; black



Item No.: 2009-414/000-005

Push-in type wire jumper; 1.5 mm²; insulated; 110 mm long; black



Item No.: 2009-416

Push-in type wire jumper; 1.5 mm²; insulated; 250 mm long; black



Item No.: 2009-414/000-006

Push-in type wire jumper; insulated; 110 mm long; black



Item No.: 2009-412

Push-in type wire jumper; insulated; 60 mm long; black

1.2.9 Screwless end stop

1.2.9.1 Mounting accessories



Item No.: 249-117

Screwless end stop; 10 mm wide; for DIN-rail 35 x 15 and 35 x 7.5; gray



Item No.: 249-116

Screwless end stop; 6 mm wide; for DIN-rail 35 x 15 and 35 x 7.5; gray

1.2.10 Test and measurement

1.2.10.1 Testing accessories



Item No.: 2002-560

Modular TOPJOB®S connector; modular; for jumper contact slot; 10-pole; gray



Item No.: 2002-511

Modular TOPJOB®S connector; modular; for jumper contact slot; 1-pole; gray



Item No.: 2002-552

Modular TOPJOB®S connector; modular; for jumper contact slot; 2-pole; gray



Item No.: 2002-553

Modular TOPJOB®S connector; modular; for jumper contact slot; 3-pole; gray



Item No.: 2002-554

Modular TOPJOB®S connector; modular; for jumper contact slot; 4-pole; gray



Item No.: 2002-555

Modular TOPJOB®S connector; modular; for jumper contact slot; 5-pole; gray



Item No.: 2002-556

Modular TOPJOB®S connector; modular; for jumper contact slot; 6-pole; gray



Item No.: 2002-557

Modular TOPJOB®S connector; modular; for jumper contact slot; 7-pole; gray



Item No.: 2002-558

Modular TOPJOB®S connector; modular; for jumper contact slot; 8-pole; gray



Item No.: 2002-559

Modular TOPJOB®S connector; modular; for jumper contact slot; 9-pole; gray



Item No.: 2002-549

Spacer module; modular; e.g., for bridging commoned terminal blocks; gray



Item No.: 2009-174

Test plug adapter; for 4 mm Ø test plugs; for testing TOPJOB®S rail-mounted terminal blocks; gray

1.2.10.1 Testing accessories



Item No.: 210-136

Test plug; 2 mm Ø; with 500 mm cable; red

Item No.: 2009-182

Testing tap; for max. 2.5 mm²; tool-free connection for individual test wires 0.08 - 2.5 mm; gray

Item No.: 2002-649

TOPJOB®S L-type spacer module; modular; e.g., for bridging commoned terminal blocks; gray

Item No.: 2002-611

TOPJOB®S L-type test plug module; modular; 1-pole; gray

1.2.11 Tool

1.2.11.1 Operating tool



Item No.: 210-658

Operating tool; Blade: 3.5 x 0.5 mm; with a partially insulated shaft; angled; short; multicoloured

Item No.: 210-720

Operating tool; Blade: 3.5 x 0.5 mm; with a partially insulated shaft; multicoloured

Installation Notes

Conductor termination

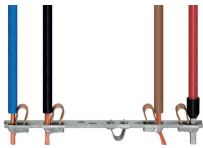

All conductor types at a glance

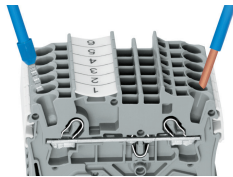

Push-in termination of solid and ferruled conductors

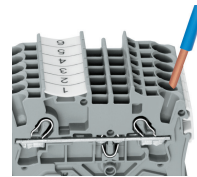

Inserting a conductor via push-in termination:
Solid conductors with cross-sections from either one size above, or up to two sizes below, the rated cross-section can be simply pushed in – no tools needed.

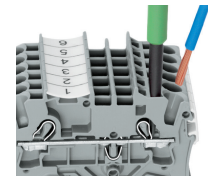

Inserting a conductor via operating tool:
Connecting fine-stranded conductors without ferrules, or small cross-sectional conductors that cannot be pushed in, is performed similarly to the original CAGE CLAMP® – just use an operating tool.
Advantage:
To open the clamp, the operating tool is inserted vertically. The conductor entry is less than 15 degrees for easier wiring.

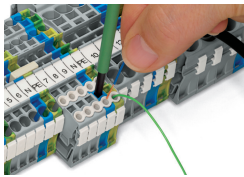

Conductor termination – insulation stop

Commoning

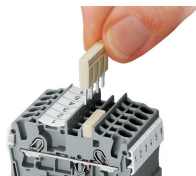

Insert push-in type jumper bar and push down until it hits backstop.

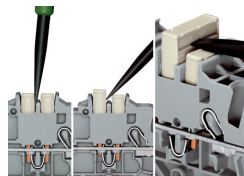

Removing a push-in type jumper bar:
Insert the operating tool between the jumper and partition wall of the dual jumper slots, then lift up the jumper.
Place the operating tool in the center of jumpers for up to five contacts (see above), or alternately on both sides for jumpers with more than five contacts.

Commoning

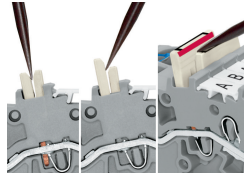
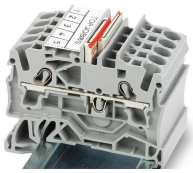

Orient the staggered jumpers' red stripes on the inside. Insert the staggered jumper and push down until it hits the backstop.

Removing a staggered jumper: Insert the operating tool between the staggered jumpers, then lift up the jumper.

Commoning

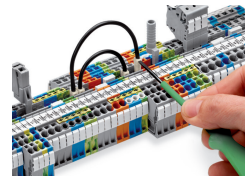
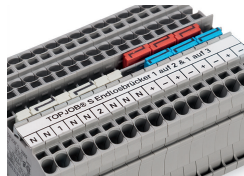
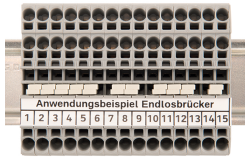

Continuous jumpers (2002 Series) readily connect an endless number of terminal blocks to each other via single jumper slot. Use the second jumper slot for additional commoning or testing.

The 1-to-3 adjacent jumper for continuous commoning enables every other terminal block to be commoned. For example, positive and negative potentials can be accommodated alongside each other.

Push down the wire jumper until fully inserted. Lift the jumper with an operating tool for rewiring.

Testing

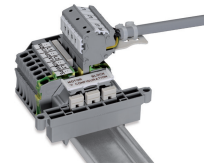
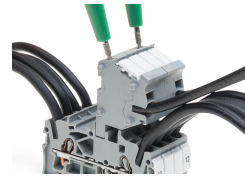
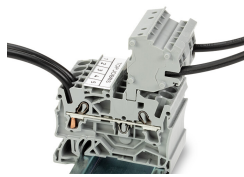
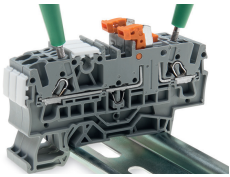

Testing with voltage tester.

The modular TOPJOB® S connectors also connect conductors of the same size as the terminal blocks being used.

TOPJOB® S Connectors with a 2 mm Ø test socket for testing voltage via 2-pole voltage tester

Rail-mount terminal block assembly for electric motor wiring



Test plug adapter (Item No. 2009-174, CAT I) for 4 mm Ø plugs – compatible with 2000 to 2016 Series

Testing tap (Item No. 2009-182) for tool-free connection of test cables up to 2.5 mm² (12 AWG) – compatible with 2000 to 2016 Series

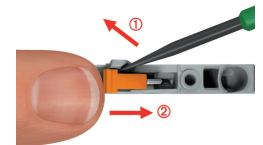
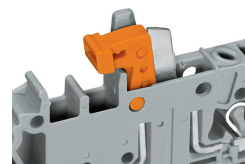
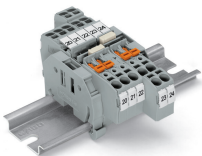

- One center and two side marker slots for WMB markers or marking strips
- Dual jumper slots in the same location as other 2002 Series terminal blocks
- Commoning options in front of or behind the knife disconnect, depending on the power supply direction

Disconnect/test terminal block with pivoting knife disconnect and mechanical interlock
Top view

Disconnect/test terminal block with pivoting knife disconnect and mechanical interlock
Knife disconnect in open position

Disconnect/test terminal block with pivoting knife disconnect and mechanical interlock
Closing the knife disconnect.

Marking

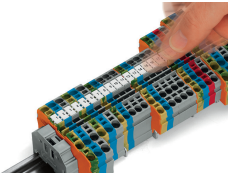

Snapping WMB Inline markers into marker slots.

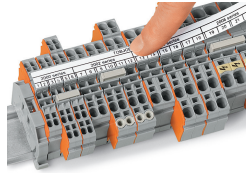

Pivoting double-deck marker carrier (2002-121) and 2-conductor disconnect/test terminal block (2002-1671)

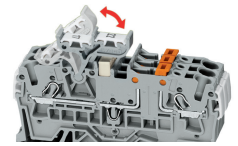
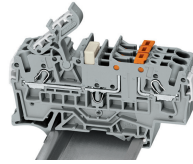

Pivoting double-deck marker carrier (2002-121) and 2-conductor disconnect/test terminal block (2002-1671)

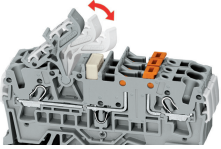

Pivoting double-deck marker carrier (2002-121) and 2-conductor disconnect/test terminal block (2002-1671)