

Productinformatieblad

Specificaties



red toggle switch head Ø22 2-position stay put cp grey

ZB5AD2804C0

EAN Code: 3606489763107

Prijs: 19,70 EUR

Hoofd

range of product	Harmony XB5
product of component type	Kop voor keuzeschakelaar
device short name	ZB5
kraag materiaal	Kunststof gekleurd grijs
bevestigingsdiameter	22 mm
verkoop per ondeelbare hoeveelheid	1
koptype	Standaard
vorm van kop signaleringseenheid	Rond
type operator	blijven
operator profiel	Zwart toggle switch
extra informatie operator	Rode hefboom
informatie positie operator	2 standen 90°

Complementair

CAD totale breedte	29 mm
CAD totale hoogte	29 mm
CAD totale diepte	45 mm
gewicht product	0,023 kg
mechanical durability	500000 cycles
naam station	XALD 1...5 uitsnijdingen XALK 2...5 uitsnijdingen
elektrische samenstellingscode	C11 voor <3 contacten gebruik enkelvoudig blokken in vooraan gemonteerd C12 voor <6 contacten gebruik enkelvoudig blokken in vooraan gemonteerd C15 voor <1 contacten gebruik enkelvoudig blokken in vooraan gemonteerd SF1 voor <3 contacten gebruik enkelvoudig blokken in vooraan gemonteerd SR1 voor <3 contacten gebruik enkelvoudig blokken in montage aan achterzijde C13 voor <6 contacten gebruik enkelvoudig en dubbel blokken in vooraan gemonteerd
product presentatie	Basisonderdeel

Omgeving

beschermende behandeling	TH
ambient air temperature for storage	-40...70 °C
omgevingstemperatuur voor werking	-40...70 °C
overvoltage category	Klasse II In overeenstemming met IEC 60536

De weergegeven prijs is de adviesprijs in euro excl. BTW. Deze kan onderhevig zijn aan korting. Neem contact op met uw lokale distributeur of detailhandel voor de daadwerkelijke prijs

IP beschermingsgraad	IP66 In overeenstemming met IEC 60529
Enclosure Type	UL type 4X/13
weerstand hoge druk drukring	7000000 Pa om 55 °C, afstand: 0.1 m
IK beschermingsgraad	IK06
standards	CSA C22.2 Nr 14 IEC 60947-1 JIS C8201-5-1 UL 508 IEC 60947-5-1 IEC 60947-5-4 JIS C8201-1
product certifications	DNV UL listed LROS (Lloyds register of shipping) BV CSA
trilling bestendigheid	5 gn (f= 2...500 Hz) In overeenstemming met IEC 60068-2-6
schokbestendigheid	30 gn (duur = 18 ms) voor halve sinusgolf versnelling In overeenstemming met IEC 60068-2-27 50 gn (duur = 11 ms) voor halve sinusgolf versnelling In overeenstemming met IEC 60068-2-27

Verpakkingseenheid

Eenheidstype van verpakking 1	PCE
Aantal eenheden in verpakking 1	1
verpakking 1 hoogte	4,2 cm
verpakking 1 breedte	3,3 cm
verpakking 1 lengte	5,2 cm
verpakking_1_gewicht	23,0 g

contractuele waarborg

Garantie (in maanden)	18
------------------------------	----

Schneider Electric wil tegen 2050 de Net Zero-status hebben bereikt via partnerschappen in de toeleveringsketen, materialen met een lagere impact en circulariteit via onze doorlopende campagne "Use Better, Use Longer, Use Again" om de levensduur van producten en de recycleerbaarheid te verlengen.

[Uitleg van Environmental Data](#) >

[Hoe evalueren we de duurzaamheid van producten?](#) >

Milieuoetadruk

Milieu Profiel

[Milieuprofiel van het product](#)

Use Better

Materialen en verpakking

Gemiddeld percentage gerecycleerde kunststof

28 %

Gemiddeld percentage gerecycleerd metaal

60 %

Pakket met gerecycleerd karton

Ja

Verpakkingen zonder kunststof

Ja

RoHS-richtlijn van de EU

[Conform](#)

REACH-verordening

[Referentie bevat geen SVHC boven drempelwaarde](#)

Use Longer

Levensduurverlenging

Reparatie

Nee

Use Again

Hervpakken en herfabriceren

Circulair Profiel

[Informatie over einde levensduur](#)

Terugname

Ja

Dimensions Drawings

Dimensions

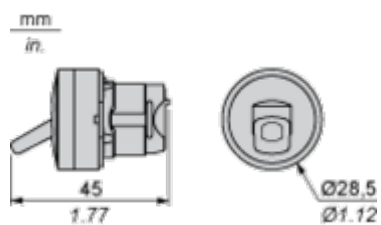

Mounting and Clearance

Panel Cut-out for Pushbuttons, Switches and Pilot Lights (Finished Holes, Ready for Installation)

Connection by Screw Clamp Terminals or Plug-in Connectors or on Printed Circuit Board

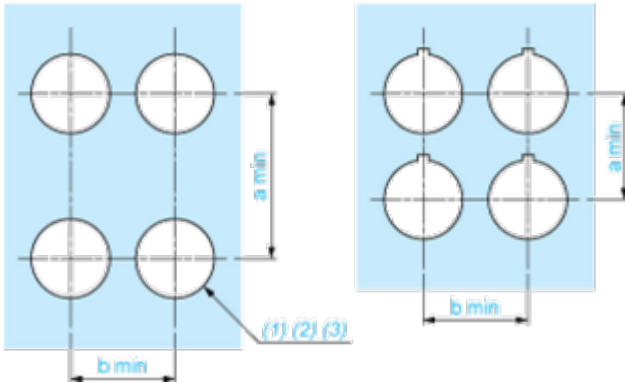

- (1) Diameter on finished panel or support
- (2) For selector switches and Emergency stop buttons, use of an anti-rotation plate type ZB5AZ902 is recommended.
- (3) $\varnothing 22.5$ mm recommended ($\varnothing 22.3 \text{ }_0^{+0.4}$) / $\varnothing 0.89$ in. recommended ($\varnothing 0.88 \text{ in. }_0^{+0.016}$)

Connections	a in mm	a in in.	b in mm	b in in.
By screw clamp terminals or plug-in connector	40	1.57	30	1.18
By Faston connectors	45	1.77	32	1.26
On printed circuit board	30	1.18	30	1.18

Detail of Lug Recess

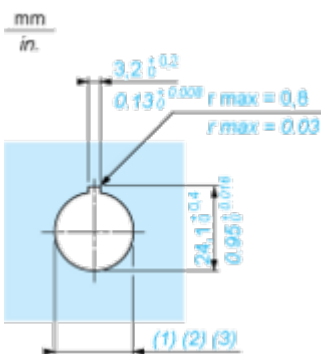

- (1) Diameter on finished panel or support
- (2) For selector switches and Emergency stop buttons, use of an anti-rotation plate type ZB5AZ902 is recommended.
- (3) $\varnothing 22.5$ mm recommended ($\varnothing 22.3 \text{ }_0^{+0.4}$) / $\varnothing 0.89$ in. recommended ($\varnothing 0.88 \text{ in. }_0^{+0.016}$)



A: 1.18 in. min.

B: 1.57 in. min.

General Tolerances of the Panel and Printed Circuit Board

The cumulative tolerance must not exceed 0.3 mm / 0.012 in.: T1 + T2 = 0.3 mm max.

Installation Precautions

- Minimum thickness of circuit board: 1.6 mm / 0.06 in.
- Cut-out diameter: 22.4 mm ± 0.1 / 0.88 in. ± 0.004
- Orientation of body/fixing collar ZB5AZ009: ± 2° 30' (excluding cut-outs marked a and b).
- Tightening torque of screws ZBZ006: 0.6 N.m (5.3 lbf.in) max.
- Allow for one ZB5AZ079 fixing collar/pillar and its fixing screws:
 - every 90 mm / 3.54 in. horizontally (X), and 120 mm / 4.72 in. vertically (Y).
 - with each selector switch head (ZB5AD*, ZB5AJ*, ZB5AG*).

The fixing centers marked a and b are diagonally opposed and must align with those marked 4 and 5.



- (1) Head ZB5AD•
- (2) Panel
- (2) Nut
- (4) Printed circuit board

Mounting of Adapter (Socket) ZBZ01•

- 1 2 elongated holes for ZBZ006 screw access
- 2 1 hole \varnothing 2.4 mm \pm 0.05 / 0.09 in. \pm 0.002 for centring adapter ZBZ01•
- 3 8 \times \varnothing 1.2 mm / 0.05 in. holes
- 4 1 hole \varnothing 2.9 mm \pm 0.05 / 0.11 in. \pm 0.002, for aligning the printed circuit board (with cut-out marked **a**)
- 5 1 elongated hole for aligning the printed circuit board (with cut-out marked **b**)
- 6 4 holes \varnothing 2.4 mm / 0.09 in. for clipping in adapter ZBZ01•

Dimensions An + 18.1 relate to the \varnothing 2.4 mm \pm 0.05 / 0.09 in. \pm 0.002 holes for centring adapter ZBZ01•.

Technical Description

Electrical Composition Corresponding to Codes C9, C11, SF1 and SR1



Electrical Composition Corresponding to Code C15

1 N/O

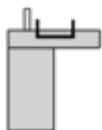

1 N/C



1 N/O + N/C or 1 N/O + N/O or 1 N/C + N/C

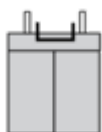

Electrical Composition Corresponding to Code C12

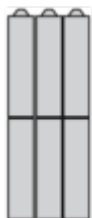

Electrical Composition Corresponding to Code C13



Legend

Single contact



Double contact



Light block



Possible location



Technical Illustration

Dimensions

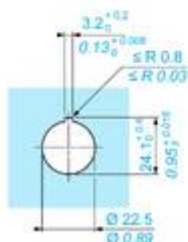
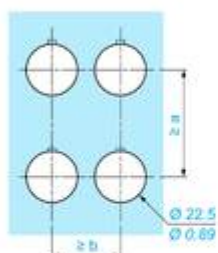
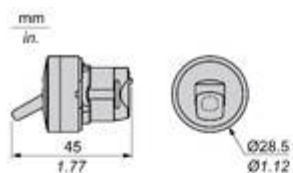

		a (mm)	a (in.)	b (mm)	b (in.)
	ZBE..... ZBV.....	40	1.57	30	1.18
	ZBE.....3 ZBV.....3	45	1.77	32	1.26
	ZBE.....4 ZBV.....4	40	1.57	30	1.18
	ZBE.....5 ZBV.....5	50	1.97	30	1.18
	ZBE.....9 ZBV.....9	40	1.57	30	1.18
	ZBRT... ZBRV1	40	1.57	30	1.18