

Data Sheet | Item Number: 221-2521

Mounting carrier; 1-way; for inline splicing connector with lever; for screw mounting; gray

<https://www.wago.com/221-2521>

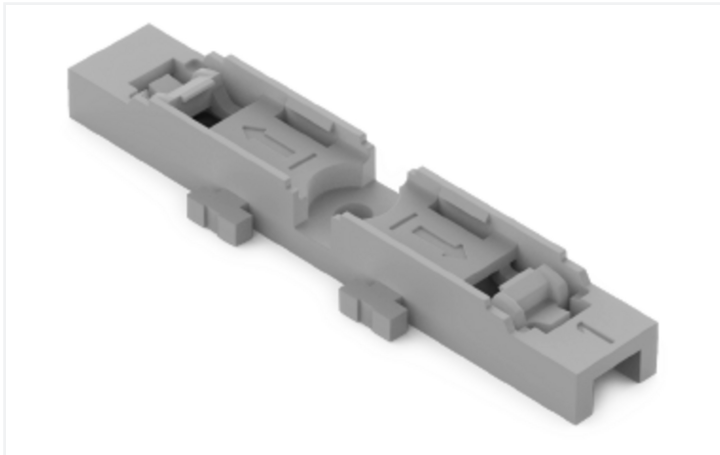

Color: ■ gray

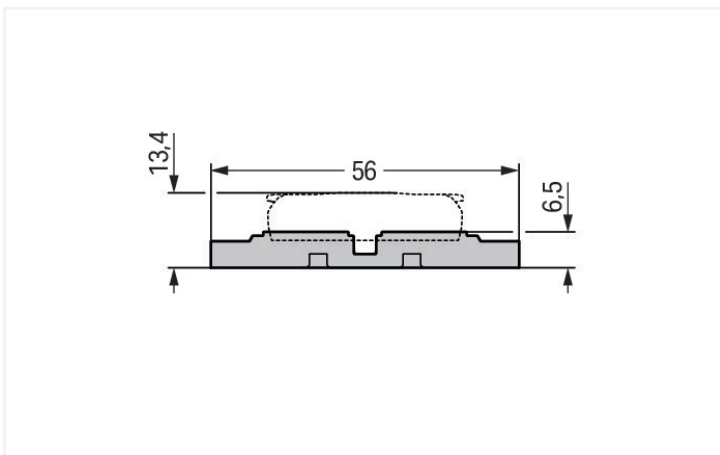
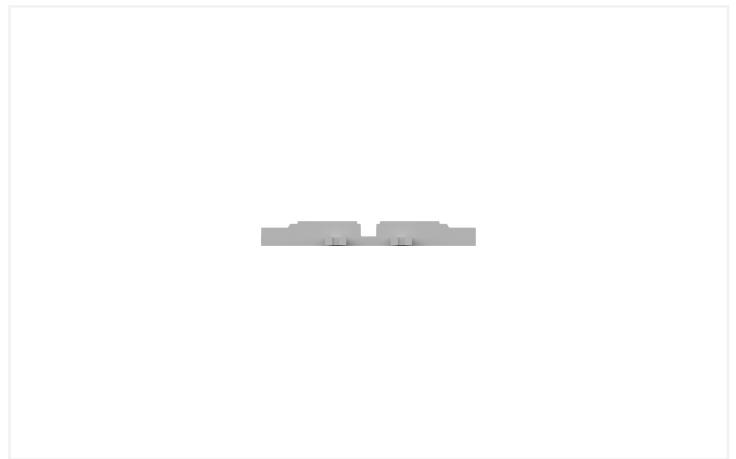

### Physical data

Width	11.8 mm / 0.465 inches
Height	6.5 mm / 0.256 inches
Height from the surface	6.5 mm / 0.256 inches
Depth	56 mm / 2.205 inches
Drilled hole diameter for snap-in mounting foot with tolerance	3.5 mm

### Mechanical data

Design	1x
Mounting type	Screw mount

### Material data

Note (material data)	<a href="#">Information on material specifications can be found here</a>
Color	gray
Material group	I
Insulation material (main housing)	Polyamide (PA66)
Flammability class per UL94	V0
Fire load	0.05 MJ
Weight	1.7 g

### Commercial data

PU (SPU)	25 (5) pcs
Packaging type	Box
Country of origin	CN
GTIN	4066966119923
Customs tariff number	39269097900

### Product Classification

UNSPSC	39121702
ETIM 9.0	EC002848
ETIM 10.0	EC002848
ECCN	NO US CLASSIFICATION

### Environmental Product Compliance

RoHS Compliance Status	Compliant, No Exemption
------------------------	-------------------------

### Downloads



#### Environmental Product Compliance

##### Compliance Search

Environmental Product  
Compliance 221-2521



## CAD/CAE-Data

CAD data	CAE data
<a href="#">2D/3D Models 221-2521</a> 	<a href="#">EPLAN Data Portal 221-2521</a> 
	<a href="#">ZUKEN Portal 221-2521</a> 

## 1 Compatible Products

### 1.1 Optional Accessories

#### 1.1.1 Installation

##### 1.1.1.1 Mounting accessories



**Item No.: 209-119**  
Fixing screw; for 209-120 mounting carrier



**Item No.: 209-123**  
Mounting foot with screw; can be screwed on terminal blocks with fixing flange; 6.4 mm wide; gray



**Item No.: 209-120**  
Mounting foot; can be snapped on terminal blocks with snap-in mounting foot; for mounting on relay-modules; 6.4 mm wide; gray

#### 1.1.2 Marking

##### 1.1.2.1 Marking strip



**Item No.: 210-834**  
Marking strips; on reel; 5 mm wide; plain; Self-adhesive; white

## Installation Notes

### Installation

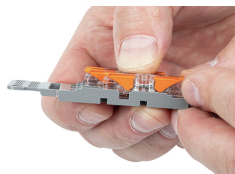

Place the inline splicing connector on the carrier in front of the mounting position.

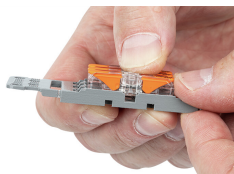

Push the connector to the center position until it snaps into place.

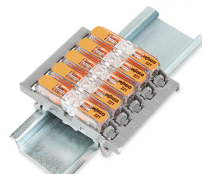

Mounting carrier without strain relief – snapped onto DIN-rail

### Strain relief

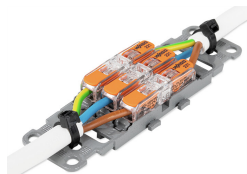

3-pole mounting carrier with strain relief

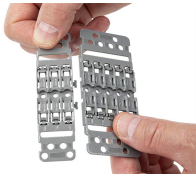

Various combinations of 1- to 5-connector mounting carriers are possible via side-by-side latching mechanism.