

# Productinformatieblad

Specificaties



## Dubbele drukknoppen, Verzonken, Ø22mm, Ongemarkeerd, Wit / zwart

ZB4BA7120

EAN Code: 3389119043816

**Prijs: 16,00 EUR**

### Hoofd

range of product	Harmony XB4
product or component type	Kop voor drukknop met dubbele kop
device short name	ZB4
kraag materiaal	Verchroomd metaal
bevestigingsdiameter	22 mm
koptype	Standaard
verkoop per ondeelbare hoeveelheid	1
vorm van kop signaleringseenheid	Rechthoekig
type operator	terugverend
operartor profiel	2 standaard knoppen
operatorbeschrijving	Wit ongemerkt - zwart ongemerkt

### Complementair

net weight	0,056 kg
weerstand hoge druk drukring	7000000 Pa bij 55 °C, afstand: 0.1 m
kleur van markering	Witte markering bij groene, rode of zwarte schildjes Zwarte markering bij witte schildjes
operator profiel	Zwart verzonken, niet gemarkeerd Wit verzonken, niet gemarkeerd
mechanical durability	1000000 cycles
elektrische samenstellingscode	C3 voor <6 contacten met enkelvoudig blokken in vooraan gemonteerd C4 voor <6 contacten met enkelvoudig en dubbel blokken in vooraan gemonteerd C14 voor <2 contacten met enkelvoudig blokken in vooraan gemonteerd
product presentatie	Basisonderdeel

### Omgeving

ambient air temperature for storage	-40...70 °C
ambient air temperature for operation	-40...70 °C
beschermingsklasse tegen elektrische schokken	Klasse I conforming to IEC 60536
IP beschermingsgraad	IP67 conform aan IEC 60529 IP69 conform aan IEC 60529
NEMA beschermingsgraad	NEMA 13 NEMA 4X
IK-beschermingsgraad	IK06 conforming to IEC 50102

De weergegeven prijs is de adviesprijs in euro excl. BTW. Deze kan onderhevig zijn aan korting. Neem contact op met uw lokale distributeur of detailhandel voor de daadwerkelijke prijs

<b>standards</b>	IEC 60947-1 IEC 60947-5-1 JIS C8201-5-1 IEC 60947-5-5 UL 508 IEC 60947-5-4 CSA C22.2 Nr 14 JIS C8201-1
<b>product certifications</b>	CSA LROS (Lloyds register of shipping) BV UL listed DNV
<b>trilling bestendigheid</b>	5 gn (f= 2...500 Hz) conforming to IEC 60068-2-6
<b>schokbestendigheid</b>	30 gn (duur = 18 ms) voor halve sinusgolf versnelling conform aan IEC 60068-2-27 50 gn (duur = 11 ms) voor halve sinusgolf versnelling conform aan IEC 60068-2-27

## Verpakkingseenheid

<b>Unit Type of Package 1</b>	PCE
<b>Number of Units in Package 1</b>	1
<b>Package 1 Height</b>	3,5 cm
<b>Package 1 Width</b>	5,4 cm
<b>Package 1 Length</b>	5,9 cm
<b>Package 1 Weight</b>	57,0 g
<b>Unit Type of Package 2</b>	S03
<b>Number of Units in Package 2</b>	200
<b>Package 2 Height</b>	30 cm
<b>Package 2 Width</b>	30 cm
<b>Package 2 Length</b>	40 cm
<b>Package 2 Weight</b>	11,94 kg

## contractuele waarborg

<b>Garantie</b>	18 months
-----------------	-----------

## Environmental Data

Schneider Electric wil tegen 2050 de Net Zero-status hebben bereikt via partnerschappen in de toeleveringsketen, materialen met een lagere impact en circulariteit via onze doorlopende campagne "Use Better, Use Longer, Use Again" om de levensduur van producten en de recycleerbaarheid te verlengen.

[Uitleg van Environmental Data](#) >

[Hoe evalueren we de duurzaamheid van producten?](#) >

### Milieuoetafdruk

Totale levenscyclus ecologische voetafdruk 1

Milieuprofiel van product (PEP) [Milieuprofiel van het product](#)

### Use Better

#### Materialen en verpakking

Pakket met gerecycleerd karton Ja

Verpakkingen zonder kunststof Ja

[EU-richtlijn RoHS](#)

Voldoet pro-actief (Product valt niet onder de EU RoHS juridische scope)

REACH-regelgeving

[REACH-verklaring](#)

### Use Again

#### Herverpakken en herfabriceren

Circulair Profiel [Informatie over einde levensduur](#)

Terugname No

Dimensions Drawings

Dimensions

---

Without Boot

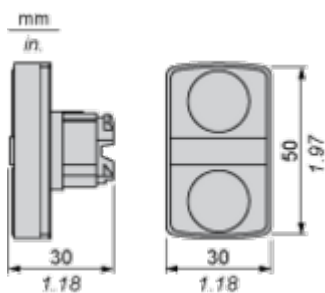

Without Boot ZBA708

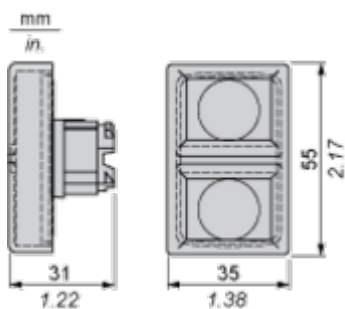

Mounting and Clearance

**Panel Cut-out for Pushbuttons, Switches and Pilot Lights (Finished Holes, Ready for Installation)**

Connection by Screw Clamp Terminals or Plug-in Connectors or on Printed Circuit Board	Connection by Faston Connectors
	
<p>(1) Diameter on finished panel or support                  (2) 40 mm min. / 1.57 in. min.                  (3) 30 mm min. / 1.18 in. min.                  (4) <math>\varnothing 22.5 \text{ mm} / 0.89 \text{ in.}</math> recommended (<math>\varnothing 22.3 \text{ mm} \begin{smallmatrix} +0.4 \\ 0 \end{smallmatrix} / 0.88 \text{ in.} \begin{smallmatrix} +0.016 \\ 0 \end{smallmatrix}</math>)                  (5) 45 mm min. / 1.78 in. min.                  (6) 32 mm min. / 1.26 in. min.</p>	



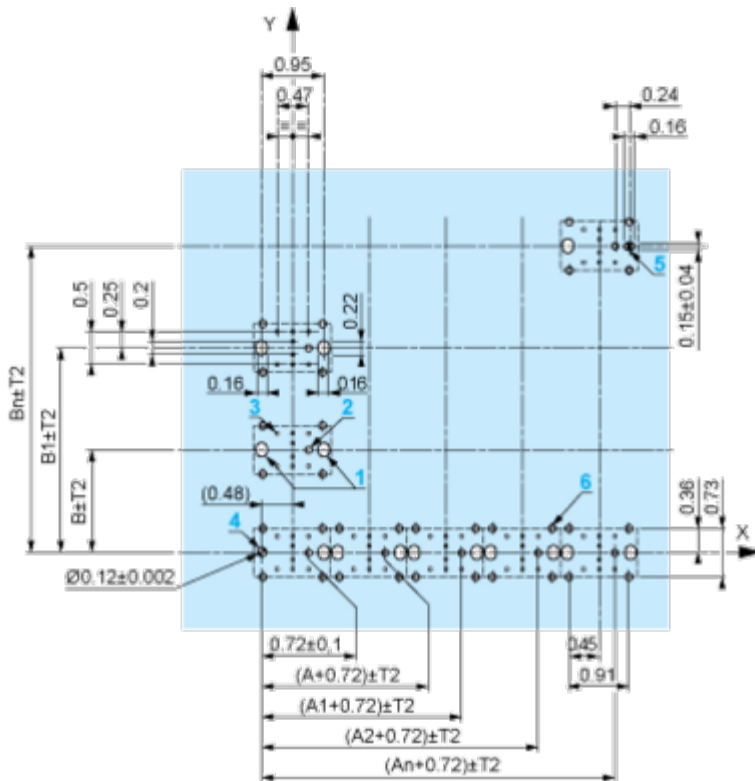

A: 1.18 in. min.

B: 1.57 in. min.

### General Tolerances of the Panel and Printed Circuit Board

The cumulative tolerance must not exceed 0.3 mm / 0.012 in:  $T1 + T2 = 0.3 \text{ mm max.}$

### Installation Precautions

- Minimum thickness of circuit board: 1.6 mm / 0.06 in.
- Cut-out diameter: 22.4 mm  $\pm$  0.1 / 0.88 in.  $\pm$  0.004
- Orientation of body/fixing collar ZB4 BZ009:  $\pm 2^\circ 30'$  (excluding cut-outs marked **a** and **b**).
- Tightening torque of screws ZBZ 006: 0.6 N.m (5.3 lbf.in) max.
- Allow for one ZB4 BZ079 fixing collar/pillar and its fixing screws:
  - every 90 mm / 3.54 in. horizontally (X), and 120 mm / 4.72 in. vertically (Y).
  - with each selector switch head (ZB4 BD\*, ZB4 BJ\*, ZB4 BG\*).

The fixing centers marked **a** and **b** are diagonally opposed and must align with those marked **4** and **5**.



(1) Panel

(2) Printed circuit board

#### Mounting of Adapter (Socket) ZBZ 01•

- 1 2 elongated holes for ZBZ 006 screw access
- 2 1 hole  $\varnothing 2.4 \text{ mm} \pm 0.05 / 0.09 \text{ in.} \pm 0.002$  for centring adapter ZBZ 01•
- 3  $8 \times \varnothing 1.2 \text{ mm} / 0.05 \text{ in.}$  holes
- 4 1 hole  $\varnothing 2.9 \text{ mm} \pm 0.05 / 0.11 \text{ in.} \pm 0.002$ , for aligning the printed circuit board (with cut-out marked a)
- 5 1 elongated hole for aligning the printed circuit board (with cut-out marked b)
- 6 4 holes  $\varnothing 2.4 \text{ mm} / 0.09 \text{ in.}$  for clipping in adapter ZBZ 01•

Dimensions An + 18.1 relate to the  $\varnothing 2.4 \text{ mm} \pm 0.05 / 0.09 \text{ in.} \pm 0.002$  holes for centring adapter ZBZ 01•.

Technical Description

Electrical Composition Corresponding to Code C3

---



Electrical Composition Corresponding to Code C4

---



Electrical Composition Corresponding to Codes C14, SF2 and SR2



**Legend**

---

Single contact



Double contact



Light block



Possible location



Technical Illustration

Dimensions

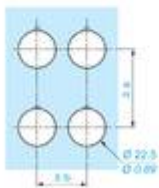
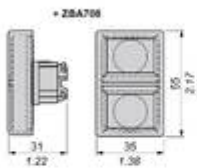
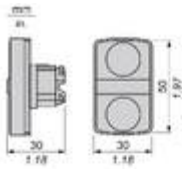

		a (mm)	a (in.)	b (mm)	b (in.)
		40	1.57	30	1.18
ZBE*****	ZDV*****				
		45	1.77	32	1.26
ZBE*****5	ZDV*****5				
		40	1.57	30	1.18
ZDE*****4	ZDV*****4				
		50	1.97	30	1.18
ZDE*****5	ZDV*****5				
		40	1.57	30	1.18
ZDE*****9	ZDV*****9				
		40	1.57	30	1.18
ZBRT*	ZBRV1				

Offer Marketing Illustration

Product benefits / Features

---

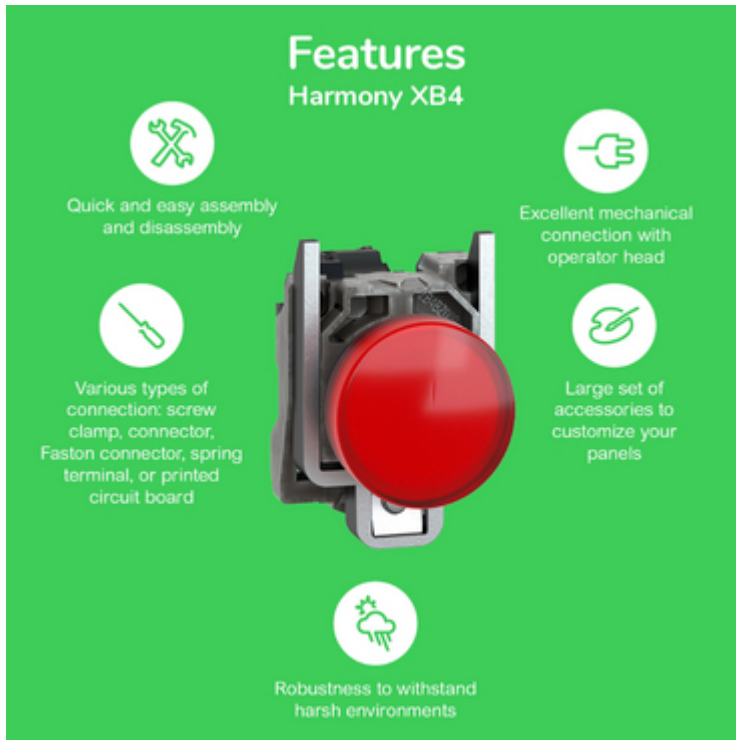

The infographic features a central image of a red Schneider XB4 circuit breaker. It is surrounded by five circular icons, each with a corresponding text block describing a feature. The background is a solid green color.

### Features Harmony XB4

- Quick and easy assembly and disassembly** (Icon: crossed wrench and screwdriver)
- Excellent mechanical connection with operator head** (Icon: hand holding a plug)
- Large set of accessories to customize your panels** (Icon: plug with a slash through it)
- Robustness to withstand harsh environments** (Icon: lightning bolt and rain cloud)
- Various types of connection: screw clamp, connector, Faston connector, spring terminal, or printed circuit board** (Icon: screwdriver)

Offer Marketing Illustration

Product benefits / Features

---

## Technical Benefits

### Harmony XB4

Conformity with IEC, UL, CSA, CCC EAC, and JIS standards, as well as CE marking and marine approvals

Up to IP66, 67, 69, 69K, and type 4X protection ratings

High vibration resistance with shake-proof terminal screws

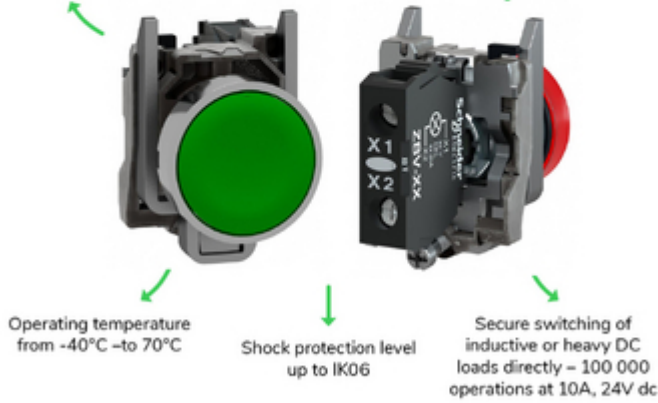

Operating temperature from -40°C to 70°C

Shock protection level up to IK06

Secure switching of inductive or heavy DC loads directly – 100 000 operations at 10A, 24V dc

Image of product / Alternate images

Alternative

---

