

Data Sheet | Item Number: 221-2531

Mounting carrier; 1-way; for inline splicing connector with lever; with snap-in mounting foot; gray

<https://www.wago.com/221-2531>

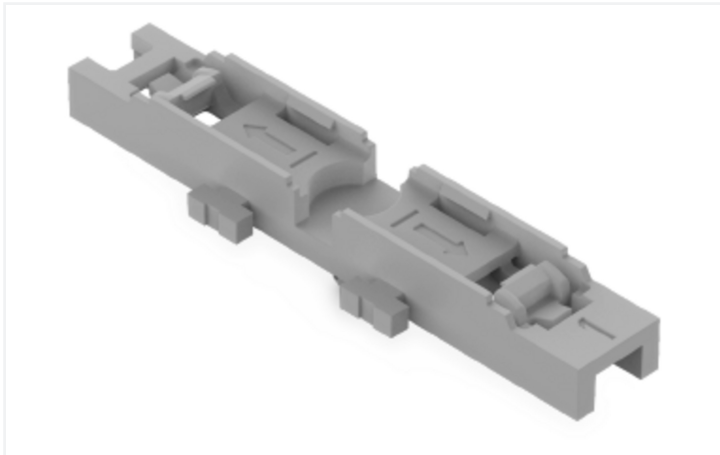

Color: ■ gray

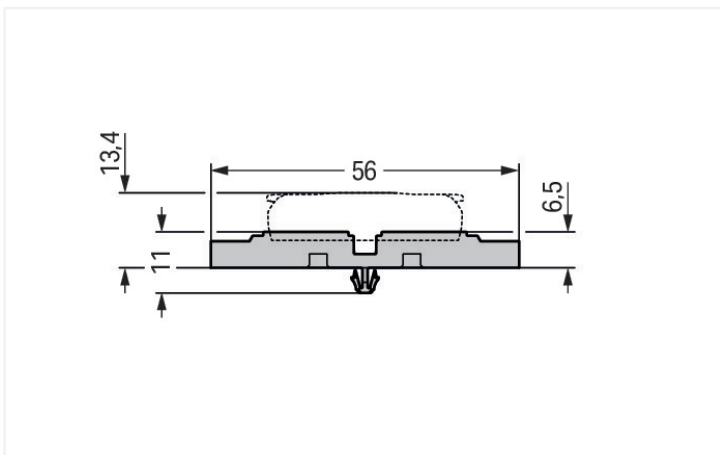
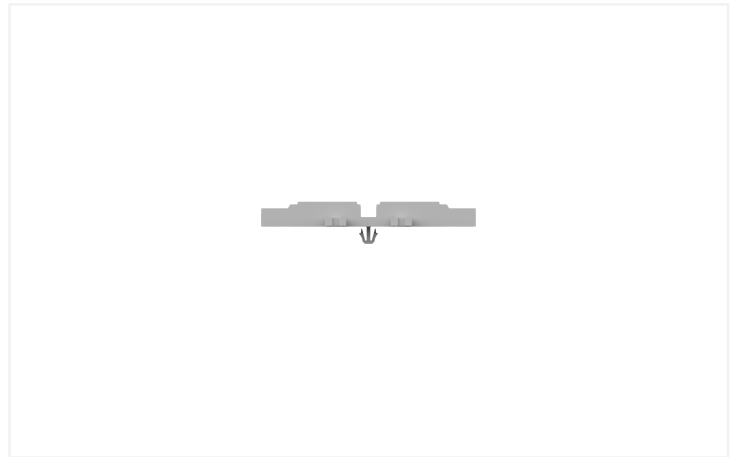

Physical data

Width	11.8 mm / 0.465 inches
Height	11.03 mm / 0.434 inches
Height from the surface	6.5 mm / 0.256 inches
Depth	56 mm / 2.205 inches

Mechanical data

Design	1x
Mounting type	Snap-in foot

Material data

Note (material data)	Information on material specifications can be found here
Color	gray
Material group	I
Insulation material (main housing)	Polyamide (PA66)
Flammability class per UL94	V0
Fire load	0.051 MJ
Weight	1.7 g

Commercial data

PU (SPU)	25 (5) pcs
Packaging type	Box
Country of origin	CN
GTIN	4066966119978
Customs tariff number	39269097900

Product Classification

UNSPSC	39121702
ETIM 9.0	EC002848
ETIM 10.0	EC002848
ECCN	NO US CLASSIFICATION

Environmental Product Compliance

RoHS Compliance Status	Compliant, No Exemption
------------------------	-------------------------

Downloads



Environmental Product Compliance

Compliance Search

Environmental Product
Compliance 221-2531



CAD/CAE-Data

CAD data	CAE data
2D/3D Models 221-2531 	EPLAN Data Portal 221-2531 
	ZUKEN Portal 221-2531 

1 Compatible Products

1.1 Optional Accessories

1.1.1 Installation

1.1.1.1 Mounting accessories



Item No.: 209-119
Fixing screw; for 209-120 mounting carrier



Item No.: 209-123
Mounting foot with screw; can be screwed on terminal blocks with fixing flange; 6.4 mm wide; gray



Item No.: 209-120
Mounting foot; can be snapped on terminal blocks with snap-in mounting foot; for mounting on relay-modules; 6.4 mm wide; gray

1.1.2 Marking

1.1.2.1 Marking strip



Item No.: 210-834
Marking strips; on reel; 5 mm wide; plain; Self-adhesive; white

Installation Notes

Installation

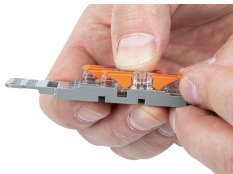

Place the inline splicing connector on the carrier in front of the mounting position.

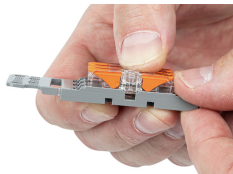

Push the connector to the center position until it snaps into place.



Mounting carrier without strain relief – snapped onto DIN-rail

Strain relief

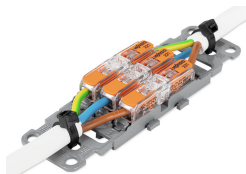

3-pole mounting carrier with strain relief

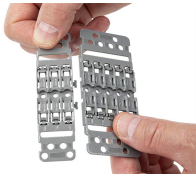

Various combinations of 1- to 5-connector mounting carriers are possible via side-by-side latching mechanism.