

## Data Sheet | Item Number: 280-879

2-conductor disconnect/test terminal block; with pivoting knife disconnect; with test port; orange disconnect link; for DIN-rail 35 x 15 and 35 x 7.5; 2.5 mm<sup>2</sup>; CAGE CLAMP®; 2,50 mm<sup>2</sup>; orange

<https://www.wago.com/280-879>

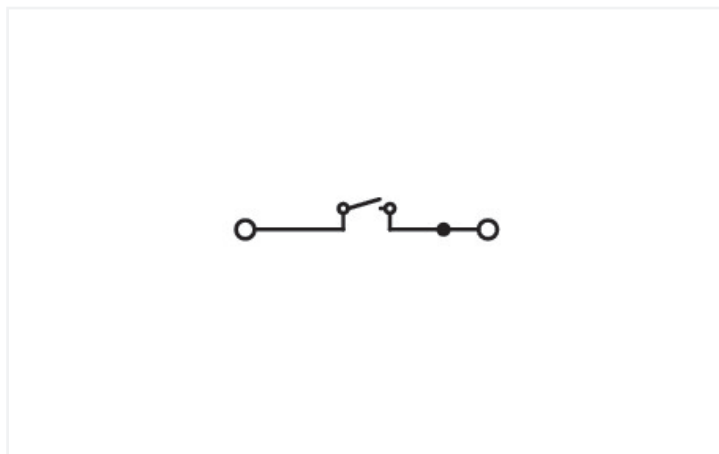
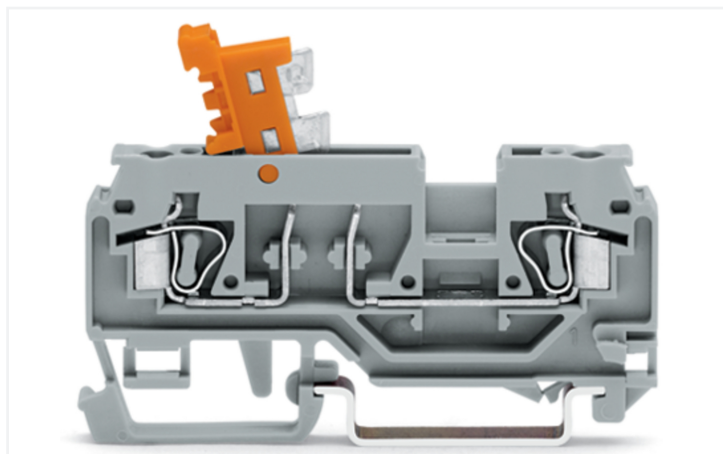

Color: ■ orange

Similar to illustration

Similar to illustration

Disconnect terminal block for test and measurement, 280 Series, operating tool

Our disconnect terminal block for test and measurement (item number 280-879) simplifies electrical installations. Conductors should only be connected to this disconnect terminal block for test and measurement if their strip length is between 8 and 9 mm. This product incorporates conductor terminals and utilizes CAGE CLAMP®. Our renowned universal connection known as CAGE CLAMP® leads the way when it comes to connection technology and electrical interconnections. This disconnect terminal block for test and measurement is suitable for conductor cross sections ranging from 0.08 mm<sup>2</sup> to 2.5 mm<sup>2</sup>.

### Electrical data

#### Ratings per IEC/EN

Nominal voltage (III/3)	400 V
Rated impulse withstand voltage (III / 3)	6 kV
Rated current	16 A
Legend (ratings)	(III / 3) ≙ Overvoltage category III / Pollution degree 3

#### Power Loss

Power loss, per pole (potential)	0.3405 W
Rated current $I_N$ for power loss specification	16 A
Resistance value for specified, current-dependent power loss	0.00133 Ω

### General information

Wiring direction	Front-entry wiring
------------------	--------------------

### Connection Data

Clamping units	2
Total number of potentials	2
Number of levels	1

#### Connection 1

Connection technology	CAGE CLAMP®
Actuation type	Operating tool
Connectable conductor materials	Copper Aluminum

## Connection 1

Connectable conductor materials (note) **Terminating Aluminum Conductors**  
WAGO Spring-Clamp Terminal Blocks are suitable for solid aluminum conductors up to 4 mm<sup>2</sup>/12 AWG if WAGO "Alu-Plus" Contact Paste [249-130](#) is used for termination.

"Alu-Plus" Contact Paste Advantages:

- Automatically destroys the oxide film during clamping.
- Prevents fresh oxidation at the clamping point.
- Prevents electrolytic corrosion between aluminum and copper conductors (in the same terminal block).
- Provides long-term protection against corrosion.

Using terminal blocks with CAGE CLAMP® Spring Pressure Connection Technology, **aluminum conductors must first be cleaned with a blade** and then immediately inserted into the clamping units filled with "Alu-Plus" contact paste.

It is also possible to apply WAGO "Alu-Plus" **additionally** on the whole surface of the aluminum conductor before termination.

Please note that the nominal currents must be adapted to the reduced conductivity of the aluminum conductors:  
2.5 mm<sup>2</sup> = 16 A  
4 mm<sup>2</sup> = 22 A

Solid conductor	0.08 ... 2.5 mm <sup>2</sup> / 28 ... 12 AWG
Fine-stranded conductor	0.08 ... 2.5 mm <sup>2</sup> / 28 ... 12 AWG
Note (conductor cross-section)	12 AWG: THHN, THWN
Strip length	8 ... 9 mm / 0.31 ... 0.35 inches
Wiring direction	Front-entry wiring

## Physical data

Width	5 mm / 0.197 inches
Height	69.5 mm / 2.736 inches
Depth from upper-edge of DIN-rail	28.5 mm / 1.122 inches

## Mechanical data

Design	horizontal type
Mounting type	DIN-35 rail
Marking level	Center/side marking

## Material data

Note (material data)	<a href="#">Information on material specifications can be found here</a>
Color	orange
Material group	I
Insulation material (main housing)	Polyamide (PA66)
Flammability class per UL94	V0
Fire load	0.152 MJ
Weight	8.6 g

### Environmental requirements

Processing temperature	-35 ... +85 °C
Continuous operating temperature	-60 ... +105 °C

### Commercial data

Product Group	1 (Rail Mounted Terminal Blocks)
PU (SPU)	100 pcs
Packaging type	Box
Country of origin	IN
GTIN	4050821014584
Customs tariff number	85365080000

### Product Classification

UNSPSC	39121410
eCl@ss 10.0	27-14-11-26
eCl@ss 9.0	27-14-11-26
ETIM 9.0	EC000902
ETIM 10.0	EC000902
ECCN	NO US CLASSIFICATION

### Environmental Product Compliance

RoHS Compliance Status	Compliant, No Exemption
------------------------	-------------------------

### Approvals / Certificates

#### General approvals



Approval	Standard	Certificate Name
CSA DEKRA Certification B.V.	C22.2	1536071
KEMA/KEUR DEKRA Certification B.V.	EN 60947	71-154769
UL Underwriters Laboratories Inc.	UL 1059	E45172

#### Declarations of conformity and manufacturer's declarations

Approval	Standard	Certificate Name
EU-Declaration of Confor- mity WAGO GmbH & Co. KG	-	-
UK-Declaration of Confor- mity WAGO GmbH & Co. KG	-	-

### Approvals for marine applications



Approval	Standard	Certificate Name
ABS American Bureau of Ship- ping	EN 60947	24-0152298-PDA
DNV GL Det Norske Veritas, Ger- manischer Lloyd	-	TAE00001V2

## Downloads

### Environmental Product Compliance

#### Compliance Search

Environmental Product Compliance 280-879



## Documentation

### Bid Text

280-879	19.02.2019	xml 3.49 KB	
280-879	02.03.2017	doc 25.00 KB	

## CAD/CAE-Data

### CAD data

2D/3D Models 280-879



### CAE data

EPLAN Data Portal 280-879



WSCAD Universe 280-879



ZUKEN Portal 280-879



## 1 Compatible Products

### 1.1 Required Accessories

#### 1.1.1 End plate

##### 1.1.1.1 End plate



#### Item No.: 280-374

End and intermediate plate; 2.5 mm thick; gray

#### Item No.: 280-371

End and intermediate plate; 2.5 mm thick; orange

### 1.2 Optional Accessories

#### 1.2.1 DIN-rail

##### 1.2.1.1 Mounting accessories



#### Item No.: 210-196

Aluminum carrier rail; 35 x 8.2 mm; 1.6 mm thick; 2 m long; unslotted; similar to EN 60715; silver-colored



#### Item No.: 210-198

Copper carrier rail; 35 x 15 mm; 2.3 mm thick; 2 m long; unslotted; according to EN 60715; copper-colored



#### Item No.: 210-508

Steel carrier rail; 35 x 15 mm; 1.5 mm thick; 2 m long; slotted; galvanized; similar to EN 60715; silver-colored



#### Item No.: 210-197

Steel carrier rail; 35 x 15 mm; 1.5 mm thick; 2 m long; slotted; similar to EN 60715; silver-colored



#### Item No.: 210-506

Steel carrier rail; 35 x 15 mm; 1.5 mm thick; 2 m long; unslotted; galvanized; similar to EN 60715; silver-colored



#### Item No.: 210-114

Steel carrier rail; 35 x 15 mm; 1.5 mm thick; 2 m long; unslotted; similar to EN 60715; silver-colored



#### Item No.: 210-118

Steel carrier rail; 35 x 15 mm; 2.3 mm thick; 2 m long; unslotted; according to EN 60715; silver-colored



#### Item No.: 210-115

Steel carrier rail; 35 x 7.5 mm; 1 mm thick; 2 m long; slotted; according to EN 60715; "Hole width 18 mm; silver-colored

1.2.1.1 Mounting accessories



**Item No.: 210-112**  
Steel carrier rail; 35 x 7.5 mm; 1 mm thick; 2 m long; slotted; according to EN 60715; "Hole width 25 mm; silver-colored



**Item No.: 210-504**  
Steel carrier rail; 35 x 7.5 mm; 1 mm thick; 2 m long; slotted; galvanized; according to EN 60715; silver-colored



**Item No.: 210-113**  
Steel carrier rail; 35 x 7.5 mm; 1 mm thick; 2 m long; unslotted; according to EN 60715; silver-colored



**Item No.: 210-505**  
Steel carrier rail; 35 x 7.5 mm; 1 mm thick; 2 m long; unslotted; galvanized; according to EN 60715; silver-colored

1.2.2 Ferrule

1.2.2.1 Ferrule



**Item No.: 216-301**  
Ferrule; Sleeve for 0.25 mm<sup>2</sup> / AWG 24; insulated; electro-tin plated; yellow



**Item No.: 216-302**  
Ferrule; Sleeve for 0.34 mm<sup>2</sup> / 22 AWG; insulated; electro-tin plated; light turquoise



**Item No.: 216-201**  
Ferrule; Sleeve for 0.5 mm<sup>2</sup> / 20 AWG; insulated; electro-tin plated; electrolytic copper; acc. to DIN 46228, Part 4/09.90; white



**Item No.: 216-101**  
Ferrule; Sleeve for 0.5 mm<sup>2</sup> / AWG 22; un-insulated; electro-tin plated; silver-colored



**Item No.: 216-202**  
Ferrule; Sleeve for 0.75 mm<sup>2</sup> / 18 AWG; insulated; electro-tin plated; gray



**Item No.: 216-102**  
Ferrule; Sleeve for 0.75 mm<sup>2</sup> / AWG 20; un-insulated; electro-tin plated; silver-colored



**Item No.: 216-203**  
Ferrule; Sleeve for 1 mm<sup>2</sup> / AWG 18; insulated; electro-tin plated; red



**Item No.: 216-103**  
Ferrule; Sleeve for 1 mm<sup>2</sup> / AWG 18; un-insulated; electro-tin plated



**Item No.: 216-204**  
Ferrule; Sleeve for 1.5 mm<sup>2</sup> / AWG 16; insulated; electro-tin plated; black



**Item No.: 216-104**  
Ferrule; Sleeve for 1.5 mm<sup>2</sup> / AWG 16; un-insulated; electro-tin plated; silver-colored

1.2.3 Installation

1.2.3.1 Cover



**Item No.: 709-153**  
Cover; Type 1; suitable for cover carrier, type 1; 1 m long; transparent

1.2.3.2 Cover carrier



**Item No.: 709-167**  
Cover carrier; Type 1; incl. fixing/retaining screws and knurled nut; suitable for 279 to 282 and 880 Series rail-mounted terminal blocks; suitable for 264 Series miniature rail-mounted terminal blocks; suitable for 270 Series sensor and actuator terminal blocks; gray

### 1.2.3.3 Mounting accessories



**Item No.: 209-106**

Mounting carrier; for isolated mounting on DIN 35 rails; gray

**Item No.: 249-116**

Screwless end stop; 6 mm wide; for DIN-rail 35 x 15 and 35 x 7.5; gray

### 1.2.4 Insulation stop

#### 1.2.4.1 Insulation stop



**Item No.: 280-470**

Insulation stop; 0.08 - 0.2 mm<sup>2</sup> "s" (0.14 mm<sup>2</sup> "f-st"); 5 pieces/strip; white

**Item No.: 280-471**

Insulation stop; 0.25 - 0.5 mm<sup>2</sup>; 5 pieces/strip; light gray

**Item No.: 280-472**

Insulation stop; 0.75 - 1 mm<sup>2</sup>; 5 pieces/strip; black

### 1.2.5 Jumper

#### 1.2.5.1 Jumper



**Item No.: 280-490**

Jumper; 10-way; insulated; gray

**Item No.: 280-482**

Jumper; 2-way; insulated; gray

**Item No.: 280-492**

Jumper; 2-way; insulated; gray

**Item No.: 280-483**

Jumper; 3-way; insulated; gray



**Item No.: 280-484**

Jumper; 4-way; insulated; gray

**Item No.: 280-485**

Jumper; 5-way; insulated; gray

**Item No.: 280-402**

Jumper; insulated; gray

**Item No.: 280-409**

Jumper; insulated; gray



**Item No.: 280-422**

Jumper; insulated; yellow-green

**Item No.: 780-452**

Staggered jumper; from 1 to 2; insulated; gray

**Item No.: 780-453**

Staggered jumper; from 1 to 3; insulated; gray

**Item No.: 780-454**

Staggered jumper; from 1 to 4; insulated; gray



**Item No.: 780-455**

Staggered jumper; from 1 to 5; insulated; gray

**Item No.: 780-456**

Staggered jumper; from 1 to 6; insulated; gray

**Item No.: 780-457**

Staggered jumper; from 1 to 7; insulated; gray

**Item No.: 780-458**

Staggered jumper; from 1 to 8; insulated; gray



**Item No.: 709-110**

Wire commoning chain; 2.5 mm<sup>2</sup>; insulated; black

**Item No.: 709-111**

Wire commoning chain; 2.5 mm<sup>2</sup>; insulated; black

**Item No.: 709-112**

Wire commoning chain; 2.5 mm<sup>2</sup>; insulated; black

**Item No.: 210-103**

Wire commoning chain; insulated; black



**Item No.: 210-123**

Wire commoning chain; insulated; blue

## 1.2.6 Marking

### 1.2.6.1 Group marker carrier



**Item No.: 209-140**  
Group marker carrier; gray



**Item No.: 209-141**  
Group marker carrier; gray



**Item No.: 209-142**  
Group marker carrier; gray

### 1.2.6.2 Marker



**Item No.: 2009-145**  
Mini-WSB Inline; for Smart Printer; 1700 pieces on roll; stretchable 5 - 5.2 mm; plain; snap-on type; white



**Item No.: 248-501**  
Mini-WSB marking card; as card; not stretchable; plain; snap-on type; white



**Item No.: 793-5501**  
WMB marking card; as card; for terminal block width 5 - 17.5 mm; stretchable 5 - 5.2 mm; plain; snap-on type; white



**Item No.: 793-501**  
WMB marking card; as card; not stretchable; plain; snap-on type; white



**Item No.: 2009-115**  
WMB-Inline; for Smart Printer; 1500 pieces on roll; stretchable 5 - 5.2 mm; plain; snap-on type; white

## 1.2.7 Protective warning marker

### 1.2.7.1 Cover



**Item No.: 280-415**  
Protective warning marker; for 5 terminal blocks; with high-voltage symbol, black; yellow

## 1.2.8 Push-in type wire jumper

### 1.2.8.1 Jumper



**Item No.: 249-126**  
Push-in type wire jumper; 0.75 mm<sup>2</sup>; insulated; 110 mm long; black



**Item No.: 249-123**  
Push-in type wire jumper; 0.75 mm<sup>2</sup>; insulated; 180 mm long; black



**Item No.: 249-127**  
Push-in type wire jumper; 0.75 mm<sup>2</sup>; insulated; 250 mm long; black



**Item No.: 249-125**  
Push-in type wire jumper; insulated; 60 mm long; black

## 1.2.9 Test and measurement

### 1.2.9.1 Testing accessories



**Item No.: 249-107**  
B-type spacer module; modular; e.g., for bridging commoned terminal blocks; gray



**Item No.: 249-106**  
B-type test plug module; modular; 1,50 mm<sup>2</sup>; gray



**Item No.: 249-142**  
L-type end module; modular; with rigid contact pin; End module; 1,50 mm<sup>2</sup>; gray



**Item No.: 249-143**  
L-type spacer module; modular; e.g., bridging commoned terminal blocks; gray



**Item No.: 249-141**  
L-type test plug module; modular; with spring-loaded contact pin; Center module; 1,50 mm<sup>2</sup>; gray



**Item No.: 280-419**  
Spacer module; modular; bridging commoned terminal blocks; gray



**Item No.: 280-404**  
Test plug adapter; 5 mm wide; for test plug (2.3 mm Ø); suitable for 1.5 mm<sup>2</sup> - 4 mm<sup>2</sup> tbs; gray



**Item No.: 209-170**  
Test plug adapter; 8.3 mm wide; for 4 mm Ø test plugs; suitable for 1.5 mm<sup>2</sup> - 10 mm<sup>2</sup> tbs; gray

1.2.9.1 Testing accessories



**Item No.: 280-418**  
 Test plug module; modular; suitable for all WAGO 280 and 780 Series rail-mounted terminal blocks with jumper slots in the current bar; gray

**Item No.: 210-136**  
 Test plug; 2 mm Ø; with 500 mm cable; red

1.2.10 Tool

1.2.10.1 Operating tool



**Item No.: 210-658**  
 Operating tool; Blade: 3.5 x 0.5 mm; with a partially insulated shaft; angled; short; multicoloured

**Item No.: 210-720**  
 Operating tool; Blade: 3.5 x 0.5 mm; with a partially insulated shaft; multicoloured

**Item No.: 210-657**  
 Operating tool; Blade: 3.5 x 0.5 mm; with a partially insulated shaft; short; multicoloured

Installation Notes

Commoning

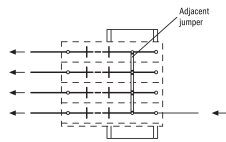
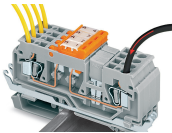

Power distribution using an adjacent jumper – knife disconnect used to disconnect individual outputs.

Power distribution using an adjacent jumper – knife disconnect used to disconnect individual outputs.

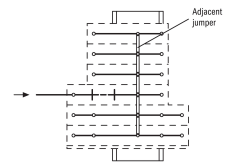

Power distribution using disconnect link in supply line – disconnection of all outputs.

Power distribution using disconnect link in supply line – disconnection of all outputs

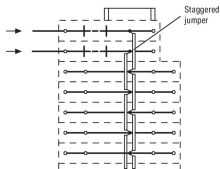

Staggered jumpers are suitable for sophisticated circuit requirements. Push jumpers down until fully inserted!

Staggered jumpers are suitable for sophisticated circuit requirements. Push jumpers down until fully inserted!



Pivoting a knife disconnect.

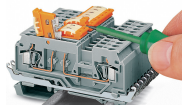

Pivoting knife disconnect clearly indicates circuit state by defined, notched positions "ON" <-> "OFF."

## Testing

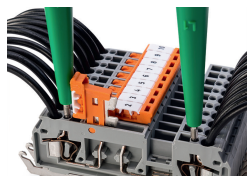

Testing with voltage tester.

## Marking



Terminal block marking: with WMB (center position) and Mini-WSB markers (on the sides)