

Data Sheet | Item Number: 280-876

2-conductor disconnect/test terminal block; with pivoting knife disconnect; with test port; orange disconnect link; suitable for Ex i applications; for DIN-rail 35 x 15 and 35 x 7.5; 2.5 mm²; CAGE CLAMP®; 2,50 mm²; blue

<https://www.wago.com/280-876>

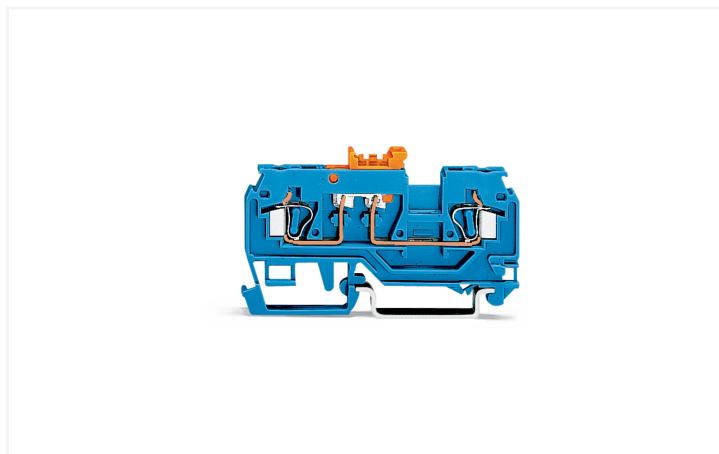
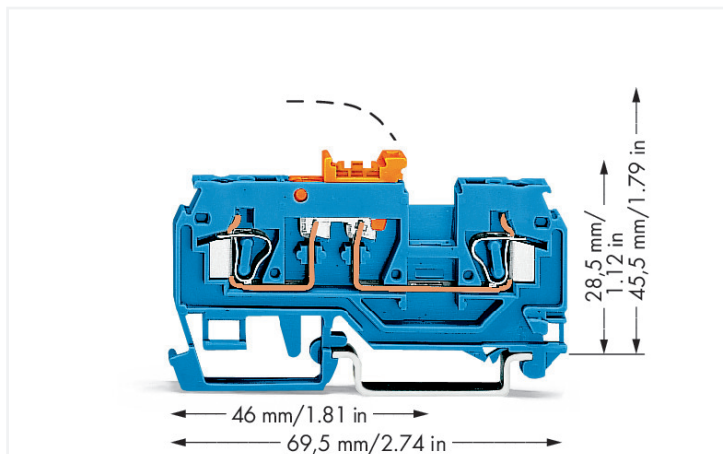

Color: ■ blue

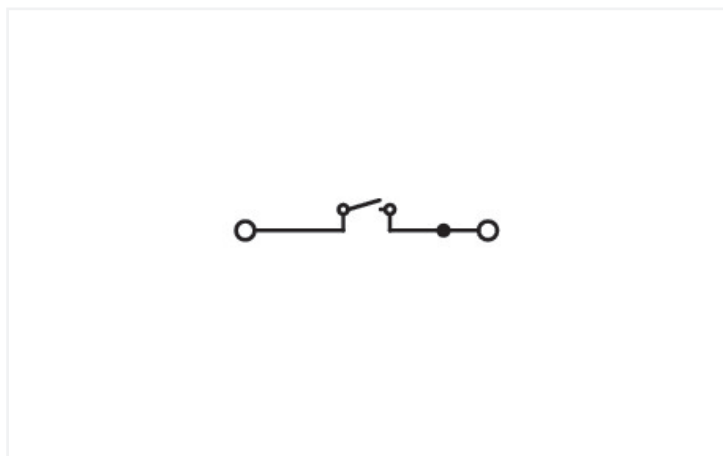

Similar to illustration

Disconnect terminal block for test and measurement, 280 Series, operating tool

Effortless electrical installations are guaranteed with this disconnect terminal block for test and measurement (item number 280-876). Strip lengths must be between 8 and 9 mm when connecting conductors to this disconnect terminal block for test and measurement. This product features conductor terminals and utilizes CAGE CLAMP®. Our highly-rated and maintenance-free CAGE CLAMP® connection makes it easy to connect all conductor types without having to prepare the conductor. For example, you don't need to crimp ferrules. This disconnect terminal block for test and measurement is suitable for conductor cross sections ranging from 0.08 mm² to 2.5 mm².

Electrical data

Ratings per IEC/EN

Nominal voltage (III/3)	400 V
Rated impulse withstand voltage (III / 3)	6 kV
Rated current	16 A
Legend (ratings)	(III / 3) ≙ Overvoltage category III / Pollution degree 3

Power Loss

Power loss, per pole (potential)	0.3405 W
Rated current I _N for power loss specification	16 A
Resistance value for specified, current-dependent power loss	0.00133 Ω

General information

Wiring direction	Front-entry wiring
------------------	--------------------

Connection Data

Clamping units	2
Total number of potentials	2
Number of levels	1

Connection 1

Connection technology	CAGE CLAMP®
Actuation type	Operating tool
Connectable conductor materials	Copper Aluminum

Connectable conductor materials (note) **Terminating Aluminum Conductors**
WAGO Spring-Clamp Terminal Blocks are suitable for solid aluminum conductors up to 4 mm²/12 AWG if WAGO "Alu-Plus" Contact Paste [249-130](#) is used for termination.

"Alu-Plus" Contact Paste Advantages:

- Automatically destroys the oxide film during clamping.
- Prevents fresh oxidation at the clamping point.
- Prevents electrolytic corrosion between aluminum and copper conductors (in the same terminal block).
- Provides long-term protection against corrosion.

Using terminal blocks with CAGE CLAMP® Spring Pressure Connection Technology, **aluminum conductors must first be cleaned with a blade** and then immediately inserted into the clamping units filled with "Alu-Plus" contact paste.

It is also possible to apply WAGO "Alu-Plus" **additionally** on the whole surface of the aluminum conductor before termination.

Please note that the nominal currents must be adapted to the reduced conductivity of the aluminum conductors:
2.5 mm² = 16 A
4 mm² = 22 A

Solid conductor	0.08 ... 2.5 mm ² / 28 ... 12 AWG
Fine-stranded conductor	0.08 ... 2.5 mm ² / 28 ... 12 AWG
Note (conductor cross-section)	12 AWG: THHN, THWN
Strip length	8 ... 9 mm / 0.31 ... 0.35 inches
Wiring direction	Front-entry wiring

Physical data

Width	5 mm / 0.197 inches
Height	69.5 mm / 2.736 inches
Depth from upper-edge of DIN-rail	28.5 mm / 1.122 inches

Mechanical data

Design	horizontal type
Mounting type	DIN-35 rail
Marking level	Center/side marking

Material data

Note (material data)	Information on material specifications can be found here
Color	blue
Material group	I
Insulation material (main housing)	Polyamide (PA66)
Flammability class per UL94	V0
Fire load	0.152 MJ
Weight	8.6 g

Environmental requirements

Processing temperature	-35 ... +85 °C
Continuous operating temperature	-60 ... +105 °C

Commercial data

Product Group	1 (Rail Mounted Terminal Blocks)
PU (SPU)	100 pcs
Packaging type	Box
Country of origin	CN
GTIN	4050821014577
Customs tariff number	85365080000

Product Classification

UNSPSC	39121410
eCl@ss 10.0	27-14-11-26
eCl@ss 9.0	27-14-11-26
ETIM 9.0	EC000902
ETIM 10.0	EC000902
ECCN	NO US CLASSIFICATION

Environmental Product Compliance

RoHS Compliance Status	Compliant, No Exemption
------------------------	-------------------------

Approvals / Certificates

General approvals



Approval	Standard	Certificate Name
CSA DEKRA Certification B.V.	C22.2	1536071
KEMA/KEUR DEKRA Certification B.V.	EN 60947	71-154769
UL Underwriters Laboratories Inc.	UL 1059	E45172

Declarations of conformity and manufacturer's declarations

Approval	Standard	Certificate Name
EU-Declaration of Conformity WAGO GmbH & Co. KG	-	-
UK-Declaration of Conformity WAGO GmbH & Co. KG	-	-

Approvals for marine applications



Approval	Standard	Certificate Name
ABS American Bureau of Ship- ping	EN 60947	24-0152298-PDA
BV Bureau Veritas S.A.	EN 60947	07436/G0 BV
DNV GL Det Norske Veritas, Ger- manischer Lloyd	-	TAE00001V2

Downloads

Environmental Product Compliance

Compliance Search
Environmental Product Compliance 280-876 ↓

Documentation

Bid Text			
280-876	19.02.2019	xml 3.48 KB	↓
280-876	02.03.2017	doc 25.00 KB	↓

CAD/CAE-Data

CAD data
2D/3D Models 280-876 ↓

CAE data
EPLAN Data Portal 280-876 ↓
WSCAD Universe 280-876 ↓
ZUKEN Portal 280-876 ↓

1 Compatible Products

1.1 Required Accessories

1.1.1 End plate

1.1.1.1 End plate



Item No.: 280-374

End and intermediate plate; 2.5 mm thick; gray

Item No.: 280-371

End and intermediate plate; 2.5 mm thick; orange

1.2 Optional Accessories

1.2.1 DIN-rail

1.2.1.1 Mounting accessories



Item No.: 210-196

Aluminum carrier rail; 35 x 8.2 mm; 1.6 mm thick; 2 m long; unslotted; similar to EN 60715; silver-colored



Item No.: 210-198

Copper carrier rail; 35 x 15 mm; 2.3 mm thick; 2 m long; unslotted; according to EN 60715; copper-colored



Item No.: 210-508

Steel carrier rail; 35 x 15 mm; 1.5 mm thick; 2 m long; slotted; galvanized; similar to EN 60715; silver-colored



Item No.: 210-197

Steel carrier rail; 35 x 15 mm; 1.5 mm thick; 2 m long; slotted; similar to EN 60715; silver-colored



Item No.: 210-506

Steel carrier rail; 35 x 15 mm; 1.5 mm thick; 2 m long; unslotted; galvanized; similar to EN 60715; silver-colored



Item No.: 210-114

Steel carrier rail; 35 x 15 mm; 1.5 mm thick; 2 m long; unslotted; similar to EN 60715; silver-colored



Item No.: 210-118

Steel carrier rail; 35 x 15 mm; 2.3 mm thick; 2 m long; unslotted; according to EN 60715; silver-colored



Item No.: 210-115

Steel carrier rail; 35 x 7.5 mm; 1 mm thick; 2 m long; slotted; according to EN 60715; "Hole width 18 mm; silver-colored



Item No.: 210-112

Steel carrier rail; 35 x 7.5 mm; 1 mm thick; 2 m long; slotted; according to EN 60715; "Hole width 25 mm; silver-colored



Item No.: 210-504

Steel carrier rail; 35 x 7.5 mm; 1 mm thick; 2 m long; slotted; galvanized; according to EN 60715; silver-colored



Item No.: 210-113

Steel carrier rail; 35 x 7.5 mm; 1 mm thick; 2 m long; unslotted; according to EN 60715; silver-colored



Item No.: 210-505

Steel carrier rail; 35 x 7.5 mm; 1 mm thick; 2 m long; unslotted; galvanized; according to EN 60715; silver-colored

1.2.2 Ferrule

1.2.2.1 Ferrule



Item No.: 216-301

Ferrule; Sleeve for 0.25 mm² / AWG 24; insulated; electro-tin plated; yellow



Item No.: 216-302

Ferrule; Sleeve for 0.34 mm² / 22 AWG; insulated; electro-tin plated; light turquoise



Item No.: 216-201

Ferrule; Sleeve for 0.5 mm² / 20 AWG; insulated; electro-tin plated; electrolytic copper; acc. to DIN 46228, Part 4/09.90; white



Item No.: 216-101

Ferrule; Sleeve for 0.5 mm² / AWG 22; un-insulated; electro-tin plated; silver-colored



Item No.: 216-202

Ferrule; Sleeve for 0.75 mm² / 18 AWG; insulated; electro-tin plated; gray



Item No.: 216-102

Ferrule; Sleeve for 0.75 mm² / AWG 20; un-insulated; electro-tin plated; silver-colored



Item No.: 216-203

Ferrule; Sleeve for 1 mm² / AWG 18; insulated; electro-tin plated; red



Item No.: 216-103

Ferrule; Sleeve for 1 mm² / AWG 18; un-insulated; electro-tin plated



Item No.: 216-204

Ferrule; Sleeve for 1.5 mm² / AWG 16; insulated; electro-tin plated; black



Item No.: 216-104

Ferrule; Sleeve for 1.5 mm² / AWG 16; un-insulated; electro-tin plated; silver-colored

1.2.3 Installation

1.2.3.1 Cover



Item No.: 709-153

Cover; Type 1; suitable for cover carrier, type 1; 1 m long; transparent

1.2.3.2 Cover carrier



Item No.: 709-167

Cover carrier; Type 1; incl. fixing/retaining screws and knurled nut; suitable for 279 to 282 and 880 Series rail-mounted terminal blocks; suitable for 264 Series miniature rail-mounted terminal blocks; suitable for 270 Series sensor and actuator terminal blocks; gray

1.2.3.3 Mounting accessories



Item No.: 209-106

Mounting carrier; for isolated mounting on DIN 35 rails; gray



Item No.: 249-116

Screwless end stop; 6 mm wide; for DIN-rail 35 x 15 and 35 x 7.5; gray

1.2.4 Insulation stop

1.2.4.1 Insulation stop



Item No.: 280-470

Insulation stop; 0.08 - 0.2 mm² "s" (0.14 mm² "f-st"); 5 pieces/strip; white



Item No.: 280-471

Insulation stop; 0.25 - 0.5 mm²; 5 pieces/strip; light gray



Item No.: 280-472

Insulation stop; 0.75 - 1 mm²; 5 pieces/strip; black

1.2.5 Jumper

1.2.5.1 Jumper



Item No.: 280-490

Jumper; 10-way; insulated; gray



Item No.: 280-482

Jumper; 2-way; insulated; gray



Item No.: 280-492

Jumper; 2-way; insulated; gray



Item No.: 280-483

Jumper; 3-way; insulated; gray



Item No.: 280-484

Jumper; 4-way; insulated; gray



Item No.: 280-485

Jumper; 5-way; insulated; gray



Item No.: 280-402

Jumper; insulated; gray



Item No.: 280-409

Jumper; insulated; gray



Item No.: 280-422

Jumper; insulated; yellow-green



Item No.: 780-452

Staggered jumper; from 1 to 2; insulated; gray



Item No.: 780-453

Staggered jumper; from 1 to 3; insulated; gray



Item No.: 780-454

Staggered jumper; from 1 to 4; insulated; gray



Item No.: 780-455

Staggered jumper; from 1 to 5; insulated; gray



Item No.: 780-456

Staggered jumper; from 1 to 6; insulated; gray



Item No.: 780-457

Staggered jumper; from 1 to 7; insulated; gray



Item No.: 780-458

Staggered jumper; from 1 to 8; insulated; gray

1.2.5.1 Jumper



Item No.: 709-110

Wire commencing chain; 2.5 mm²; insulated; black



Item No.: 709-111

Wire commencing chain; 2.5 mm²; insulated; black



Item No.: 709-112

Wire commencing chain; 2.5 mm²; insulated; black



Item No.: 210-103

Wire commencing chain; insulated; black



Item No.: 210-123

Wire commencing chain; insulated; blue

1.2.6 Marking

1.2.6.1 Group marker carrier



Item No.: 209-140

Group marker carrier; gray



Item No.: 209-141

Group marker carrier; gray



Item No.: 209-142

Group marker carrier; gray

1.2.6.2 Marker



Item No.: 2009-145

Mini-WSB Inline; for Smart Printer; 1700 pieces on roll; stretchable 5 - 5.2 mm; plain; snap-on type; white



Item No.: 248-501

Mini-WSB marking card; as card; not stretchable; plain; snap-on type; white



Item No.: 793-5501

WMB marking card; as card; for terminal block width 5 - 17.5 mm; stretchable 5 - 5.2 mm; plain; snap-on type; white



Item No.: 793-501

WMB marking card; as card; not stretchable; plain; snap-on type; white



Item No.: 2009-115

WMB-Inline; for Smart Printer; 1500 pieces on roll; stretchable 5 - 5.2 mm; plain; snap-on type; white

1.2.7 Protective warning marker

1.2.7.1 Cover



Item No.: 280-415

Protective warning marker; for 5 terminal blocks; with high-voltage symbol, black; yellow

1.2.8 Push-in type wire jumper

1.2.8.1 Jumper



Item No.: 249-126

Push-in type wire jumper; 0.75 mm²; insulated; 110 mm long; black



Item No.: 249-123

Push-in type wire jumper; 0.75 mm²; insulated; 180 mm long; black



Item No.: 249-127

Push-in type wire jumper; 0.75 mm²; insulated; 250 mm long; black



Item No.: 249-125

Push-in type wire jumper; insulated; 60 mm long; black

1.2.9 Test and measurement

1.2.9.1 Testing accessories



Item No.: 249-107
B-type spacer module; modular; e.g., for bridging commoned terminal blocks; gray



Item No.: 249-106
B-type test plug module; modular; 1,50 mm²; gray



Item No.: 249-142
L-type end module; modular; with rigid contact pin; End module; 1,50 mm²; gray



Item No.: 249-143
L-type spacer module; modular; e.g., bridging commoned terminal blocks; gray



Item No.: 249-141
L-type test plug module; modular; with spring-loaded contact pin; Center module; 1,50 mm²; gray



Item No.: 280-419
Spacer module; modular; bridging commoned terminal blocks; gray



Item No.: 280-404
Test plug adapter; 5 mm wide; for test plug (2.3 mm Ø); suitable for 1.5 mm² - 4 mm² tbs; gray



Item No.: 209-170
Test plug adapter; 8.3 mm wide; for 4 mm Ø test plugs; suitable for 1.5 mm² - 10 mm² tbs; gray



Item No.: 280-418
Test plug module; modular; suitable for all WAGO 280 and 780 Series rail-mounted terminal blocks with jumper slots in the current bar; gray



Item No.: 210-136
Test plug; 2 mm Ø; with 500 mm cable; red

1.2.10 Tool

1.2.10.1 Operating tool



Item No.: 210-658
Operating tool; Blade: 3.5 x 0.5 mm; with a partially insulated shaft; angled; short; multicoloured



Item No.: 210-720
Operating tool; Blade: 3.5 x 0.5 mm; with a partially insulated shaft; multicoloured



Item No.: 210-657
Operating tool; Blade: 3.5 x 0.5 mm; with a partially insulated shaft; short; multicoloured

Installation Notes

Commoning

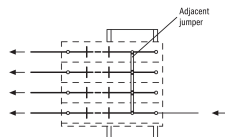
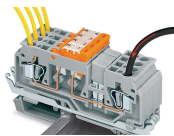

Power distribution using an adjacent jumper – knife disconnect used to disconnect individual outputs.

Power distribution using an adjacent jumper – knife disconnect used to disconnect individual outputs.

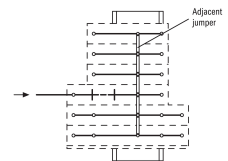

Power distribution using disconnect link in supply line – disconnection of all outputs.

Power distribution using disconnect link in supply line – disconnection of all outputs

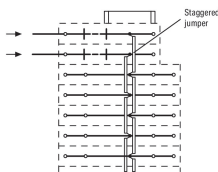
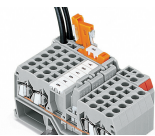

Staggered jumpers are suitable for sophisticated circuit requirements. Push jumpers down until fully inserted!

Staggered jumpers are suitable for sophisticated circuit requirements. Push jumpers down until fully inserted!

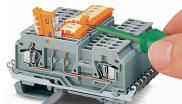

Pivoting a knife disconnect.

Pivoting knife disconnect clearly indicates circuit state by defined, notched positions "ON" <-> "OFF."

Testing

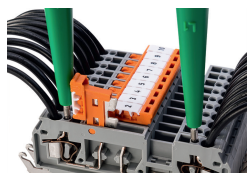

Testing with voltage tester.

Marking



Terminal block marking: with WMB (center position) and Mini-WSB markers (on the sides)