

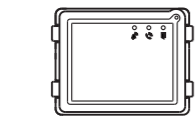

Module overview

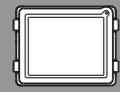

Audio module
(Only for Welcome)

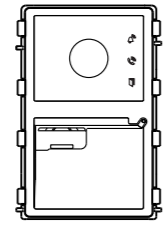

Audio/video module

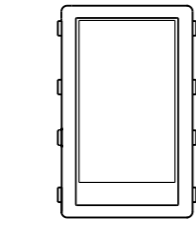

Touch 5 module
(Only for Welcome IP)

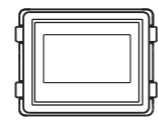

Display module

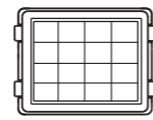

Keypad module

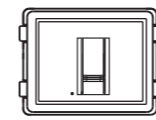

Fingerprint module

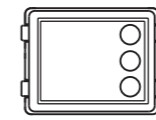

Round pushbutton
module

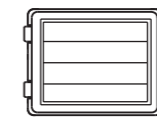

Bar pushbutton
module

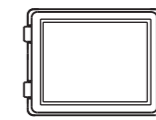

Information module

Cover frame (Unit: mm)

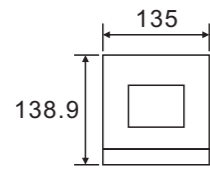

Cover frame 1/1
(Only for Welcome)

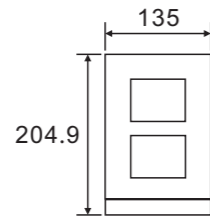

Cover frame 1/2
(Only for Welcome)

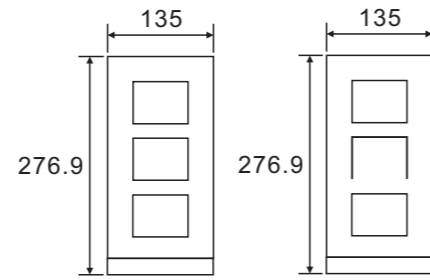

Cover frame 1x3

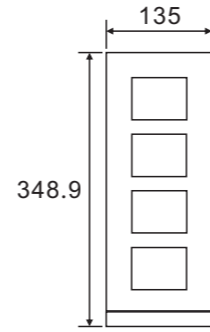

Cover frame 1x4

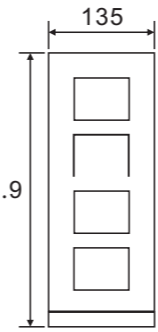

Cover frame 1x5

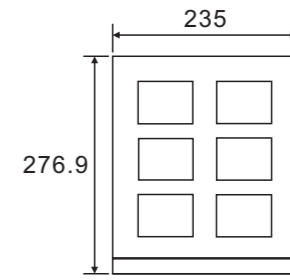
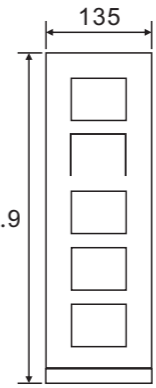

Cover frame 2x3

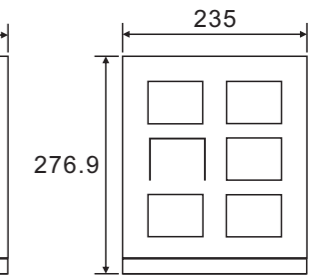

Surface-mounted box (Unit: mm)

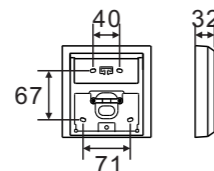
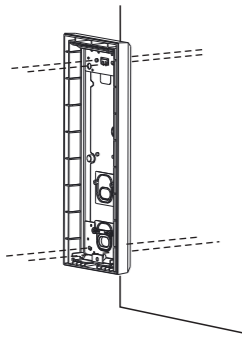

1x1

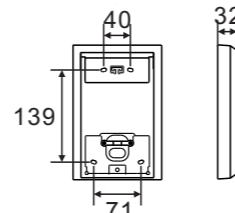

1x2

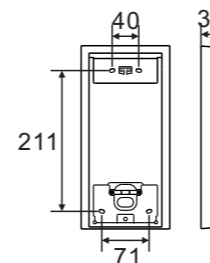

1x3

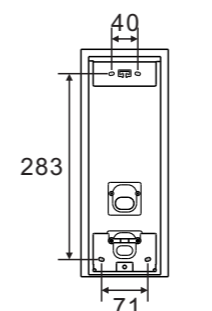

1x4

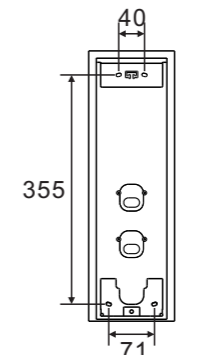

1x5

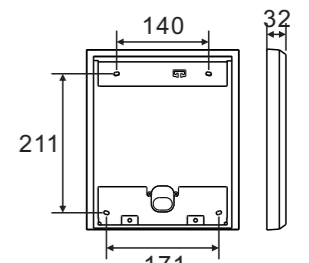

2x3

Hole size for flush-mounted box (Unit: mm)

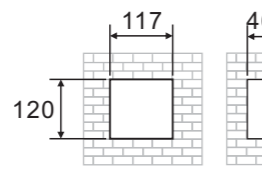
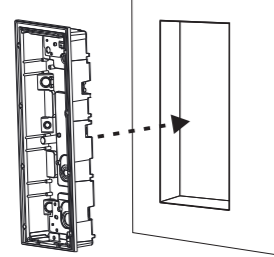

1x1

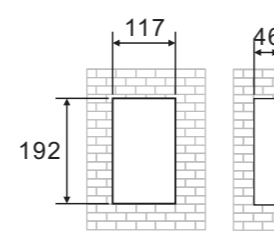

1x2

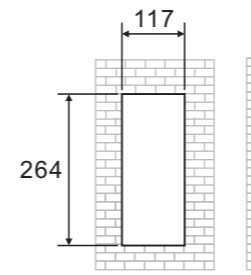

1x3

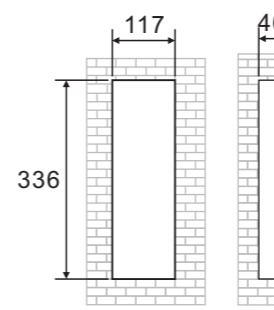

1x4

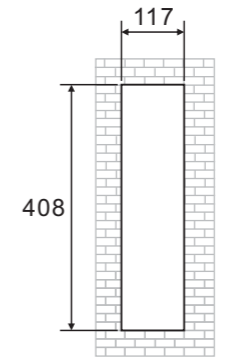

1x5

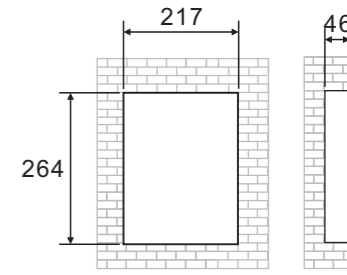

2x3

Hole size for pre-installation box (Unit: mm)

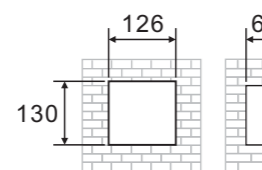
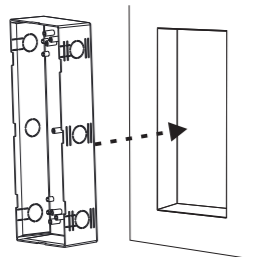

1x1

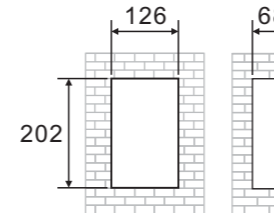

1x2

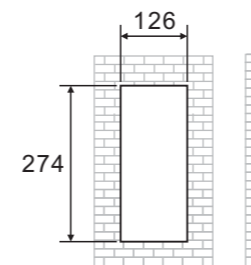

1x3

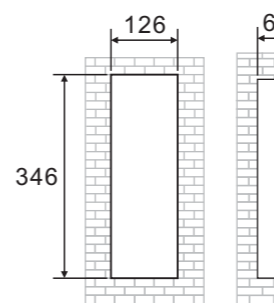

1x4

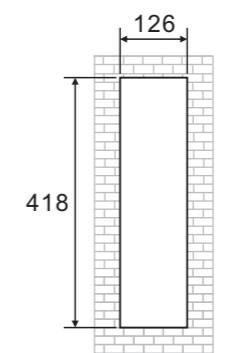

1x5

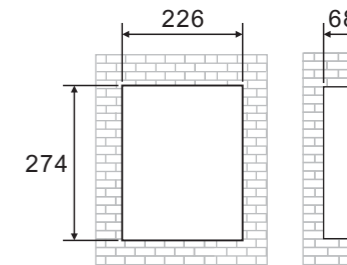

2x3



Preparation

Use gloves to protect yourself against cuts.

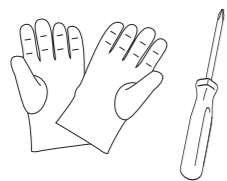

Modules mounting and wiring

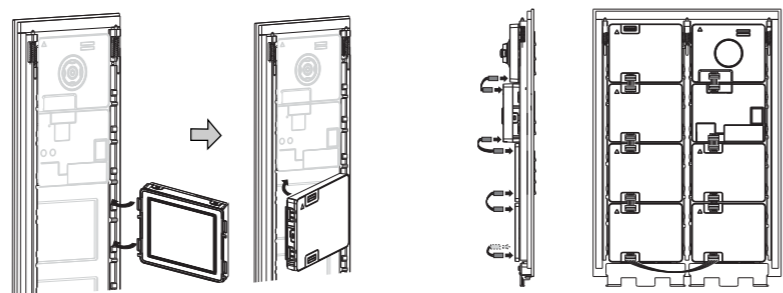

Adjust the camera view

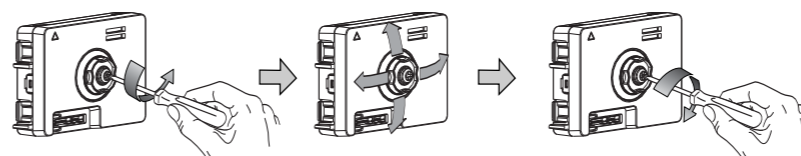

Installation height

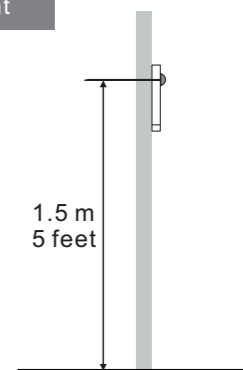

Surface-mounted installation

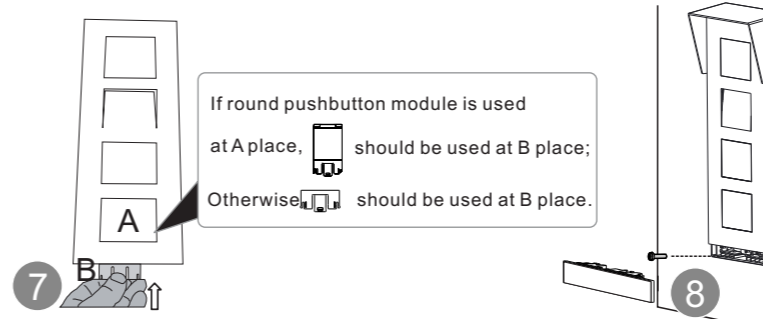
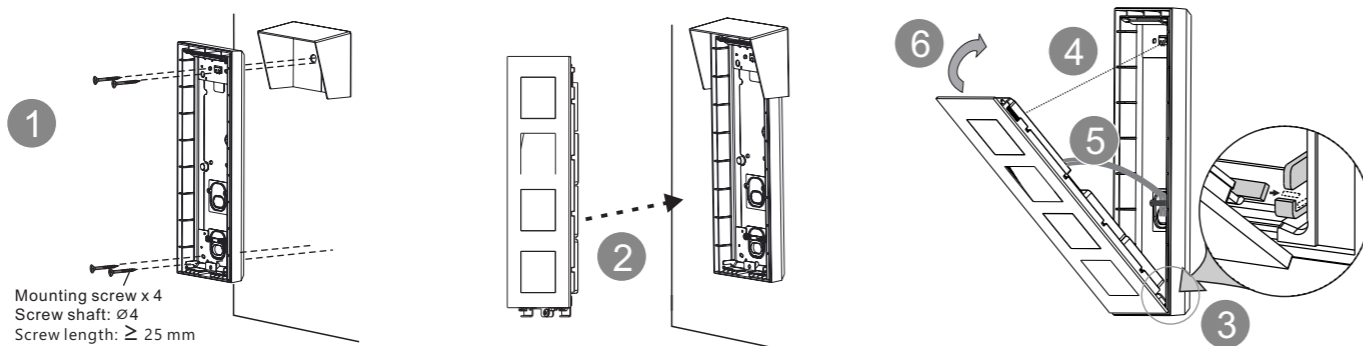

If round pushbutton module is used at A place, [icon] should be used at B place; Otherwise, [icon] should be used at B place.

Flush-mounted without pre-installation box

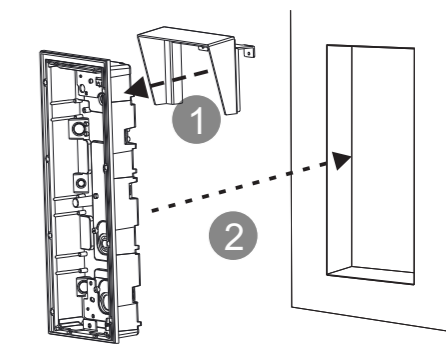

Flush-mounted with pre-installation box

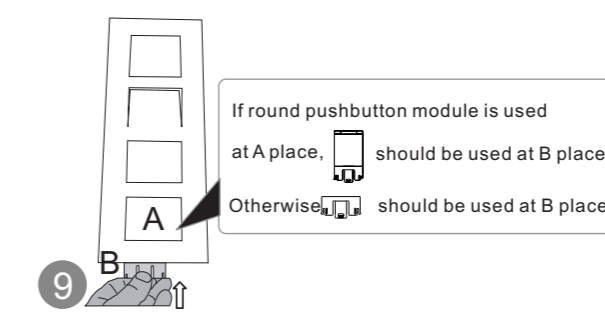
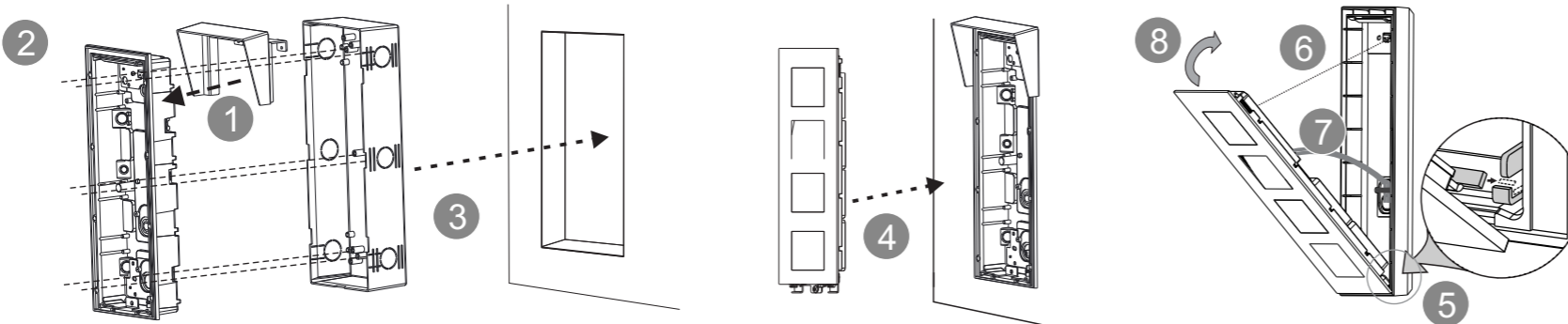

If round pushbutton module is used at A place, [icon] should be used at B place; Otherwise, [icon] should be used at B place.

Cavity wall installation

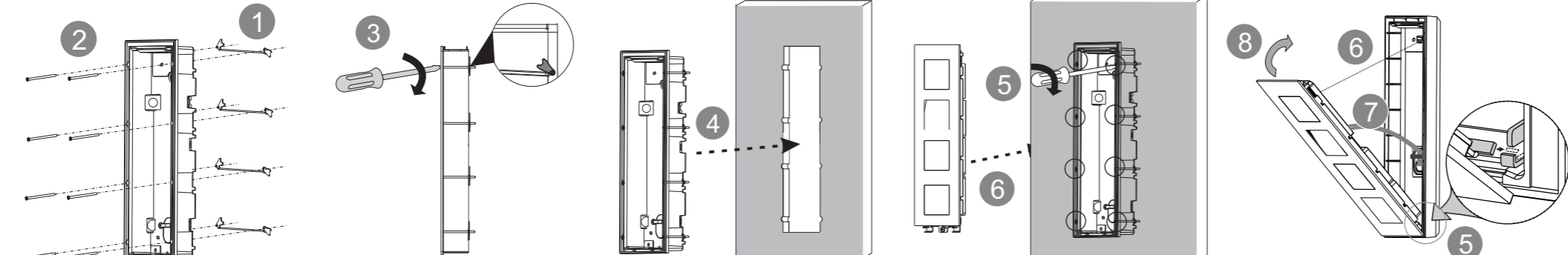

A and B is the same with surface mounted.

Dismantle the outdoor station from the wall

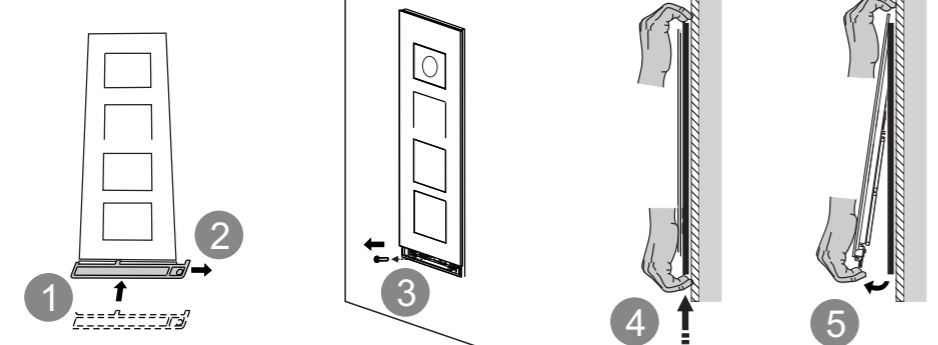

Dismantle the modules

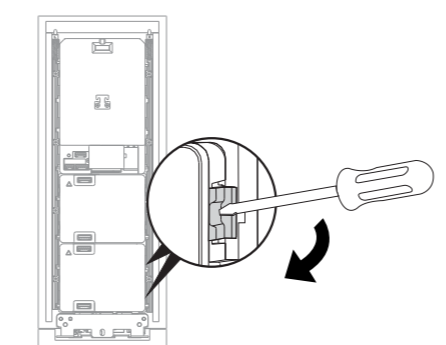

Dismantle the name label

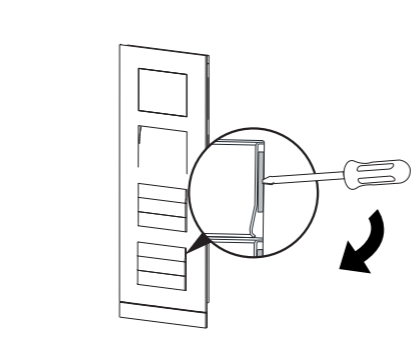

Replace the nameplate

