

**TARA Single-hole basin mixer with pop-up waste - Brushed Durabrass (23kt Gold)**















TARA

22 302 892 Product version from 6/30/2009 to 5/27/2021



- 100mm projection
- pivotable spout 360°
- circular, air-enriched flow
- height of mixer 235 mm
- height up to aerator 134 mm
- hole diameter 35 mm
- rosette Ø 59 mm
- 2x screw-in M 10 x 1 pressure hose, leak-tested
- max. flow 7 l/min
- lead-free
- This product can help a building meet the requirements of Green Building Rating Systems, e.g. LEED®, BREEAM®, DGNB
- WRAS

Only suitable for basins with an overflow.

	Brushed Durabrass (23kt Gold)	22 302 892-28
	Chrome	22 302 892-00
	Brushed Platinum	22 302 892-06
	Platinum	22 302 892-08
	Dark Chrome	22 302 892-19
	Matte Black	22 302 892-33
	Brushed Gold (PVD)	22 302 892-37
	Brushed Dark Brass (PVD)	22 302 892-39
	Brushed Bronze (PVD)	22 302 892-42
	Brushed Dark Bronze (PVD)	22 302 892-43
	Brushed Champagne (22kt Gold)	22 302 892-46
	Champagne (22kt Gold)	22 302 892-47
	Brushed Chrome	22 302 892-93
	Brushed Dark Platinum	22 302 892-99

22 302 892 Product version from 6/30/2009 to 5/27/2021

mm [inches]

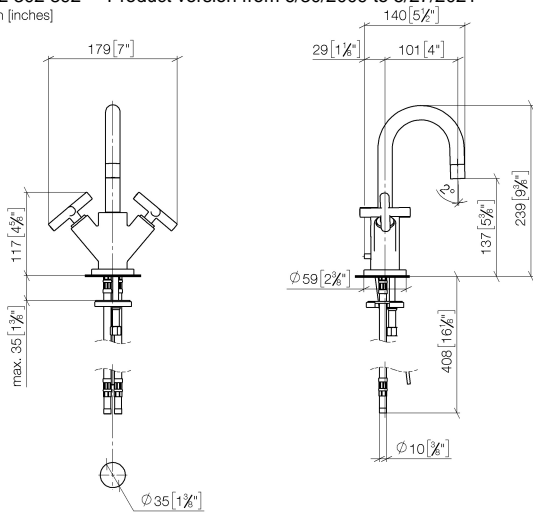

**Flow rate chart**



**Codes & Standards**

DIN 4109

EN 200

Executive Order  
no. 1007

ISO 3822

Scottish Water  
Byelaws

UK Water Supply  
Regulations

Ü-Zeichen

VA-Zeichen



TARA Single-hole basin mixer with pop-up waste - Brushed Durabronz (23kt Gold)

TARA

---

22 302 892 Product version from 6/30/2009 to 5/27/2021

Certificates and sustainability

---

ETA\_18

WRAS\_240702

LGA\_18

GDV\_0400

EPD-DOR-20230287  
-IBA1-EN  
Environmental.prod  
uct-declarat

**TARA Single-hole basin mixer with pop-up waste - Brushed Durabrass (23kt Gold)**

TARA

22 302 892 Product version from 6/30/2009 to 5/27/2021

Parts for other finishes can be found here: [Chrome](#)

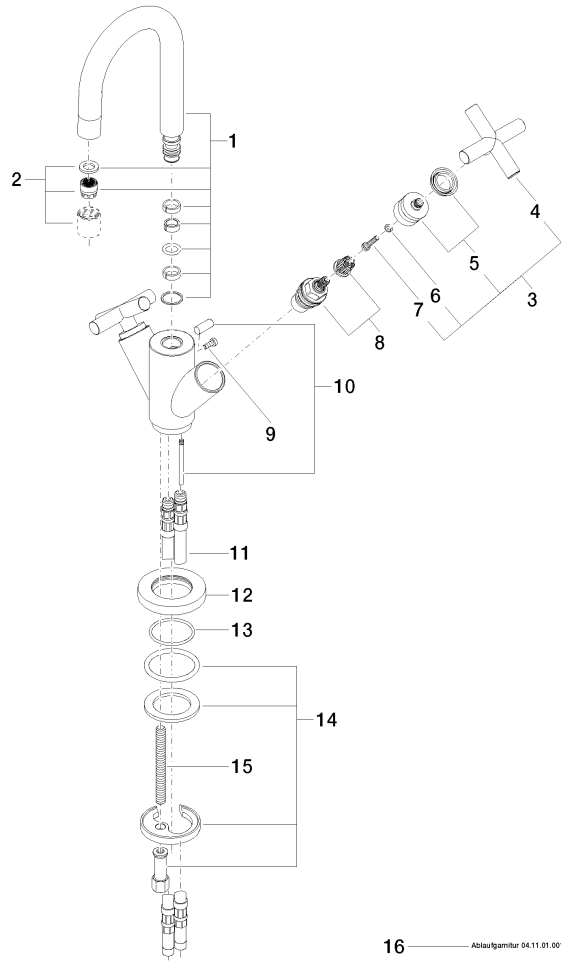

16 ——— Abbauplan für 04.11.01.001.00-ff



# TARA Single-hole basin mixer with pop-up waste - Brushed Durabron (23kt Gold)

TARA

22 302 892 Product version from 6/30/2009 to 5/27/2021

## Spare parts list

No.	Item Number	Name	Quantity used	Delivery time
3	90 20 89 010 10-28	Handle TARA - Brushed Durabron (23kt Gold)	2.00	40
13	09 14 10 134 90	O-Ring 35,2 x 2,2 mm -	1.00	14
14	04 30 11 038 00 90	Mounting with O-ring Ø40 x 4mm Ø 52 x 1,5 mm -	1.00	14
10	04 20 89 035 80-28	Pull rod for pop-up waste with button 64,9 x 399,3 x 7 mm - Brushed Durabron (23kt Gold)	1.00	40
15	09 31 11 011 90	Mounting Threaded bolt M8 x 80 mm -	1.00	14
9	09 30 30 054 90	Mounting Cylinder head screw with hexagon socket with low profile M4 x 10 mm -	1.00	14
7	90 30 30 075 00 90	Mounting Cylinder head screw with hexagon socket Low profile M4 x 20 mm -	2.00	14
8	90 90 03 151 00 90	Head part clockwise closing 1/2" -	2.00	14
2	90 23 01 028 03-28	Aerator M18xIG 7,0 l/min. - Brushed Durabron (23kt Gold)	1.00	40
6	90 30 11 029 00 90	Connection Spring lock washer Ø 4 -	2.00	14
12	09 28 10 132-28	Rosette Ø 59 x Ø 35 x 9 mm - Brushed Durabron (23kt Gold)	1.00	40
1	90 28 22 215 01-28	Spout 100 mm, 7 l/min. - Brushed Durabron (23kt Gold)	1.00	40
16	90 11 01 001 00-28	Basin Waste - Brushed Durabron (23kt Gold)	1.00	40
5	90 12 12 007 00-28	Handle Socket retainer Ø 29 x 26 mm - Brushed Durabron (23kt Gold)	2.00	40
4	09 20 89 010-28	Handle 70 x 70 x 22,5 mm - Brushed Durabron (23kt Gold)	2.00	-
	Spare part can no longer be ordered, please order the replacement item			
	90208901010-28	Handle TARA - Brushed Durabron (23kt Gold)		
11	04 30 04 016 00 90	High pressure hose M10x1 x 420 mm -	2.00	-
	Spare part can no longer be ordered, please order the replacement item			
	0430041040090	High pressure hose M10x1 x 3/8" x 420 mm -		