

Productinformatieblad

Specificaties



Ø22mm, dubbele drukknop Groen-Rood met markering

ZB4BL7341

EAN Code: 3389119043861

Prijs: 18,25 EUR

Hoofd

range of product	Harmony XB4
product or component type	Kop voor drukknop met dubbele kop
device short name	ZB4
kraag materiaal	Verchroomd metaal
bevestigingsdiameter	22 mm
koptype	Standaard
verkoop per ondeelbare hoeveelheid	1
vorm van kop signaleringseenheid	Rechthoekig
type operator	terugverend
operartor profiel	1 standaard knop - 1 verhoogde knop
operatorbeschrijving	Groen 'I' - rood 'O'

Complementair

net weight	0,056 kg
weerstand hoge druk drukring	7000000 Pa bij 55 °C, afstand: 0.1 m
kleur van markering	Witte markering bij groene, rode of zwarte schildjes Zwarte markering bij witte schildjes
operator profiel	Groen verzonken, I (wit) Rood uitspringend, O (wit)
mechanical durability	1000000 cycles
elektrische samenstellingscode	C3 voor <6 contacten met enkelvoudig blokken in vooraan gemonteerd C4 voor <6 contacten met enkelvoudig en dubbel blokken in vooraan gemonteerd C14 voor <2 contacten met enkelvoudig blokken in vooraan gemonteerd
product presentatie	Basisonderdeel

Omgeving

ambient air temperature for storage	-40...70 °C
ambient air temperature for operation	-40...70 °C
beschermingsklasse tegen elektrische schokken	Klasse I conforming to IEC 60536
IP beschermingsgraad	IP69 conform aan IEC 60529 IP66 conform aan IEC 60529 IP69K
NEMA beschermingsgraad	NEMA 13 NEMA 4X

De weergegeven prijs is de adviesprijs in euro excl. BTW. Deze kan onderhevig zijn aan korting. Neem contact op met uw lokale distributeur of detailhandel voor de daadwerkelijke prijs

IK-beschermingsgraad	IK03 conforming to IEC 50102
standards	IEC 60947-5-4 IEC 60947-1 IEC 60947-5-1 JIS C8201-5-1 UL 508 CSA C22.2 Nr 14 IEC 60947-5-5 JIS C8201-1
product certifications	CSA LROS (Lloyds register of shipping) BV UL listed DNV
trilling bestendigheid	5 gn (f= 2...500 Hz) conforming to IEC 60068-2-6
schokbestendigheid	30 gn (duur = 18 ms) voor halve sinusgolf versnelling conform aan IEC 60068-2-27 50 gn (duur = 11 ms) voor halve sinusgolf versnelling conform aan IEC 60068-2-27

Verpakkingseenheid

Unit Type of Package 1	PCE
Number of Units in Package 1	1
Package 1 Height	5,500 cm
Package 1 Width	3,300 cm
Package 1 Length	5,300 cm
Package 1 Weight	58,000 g
Unit Type of Package 2	S03
Number of Units in Package 2	200
Package 2 Height	30,000 cm
Package 2 Width	30,000 cm
Package 2 Length	40,000 cm
Package 2 Weight	12,007 kg

contractuele waarborg

Garantie	18 months
-----------------	-----------

Environmental Data

Schneider Electric wil tegen 2050 de Net Zero-status hebben bereikt via partnerschappen in de toeleveringsketen, materialen met een lagere impact en circulariteit via onze doorlopende campagne "Use Better, Use Longer, Use Again" om de levensduur van producten en de recycleerbaarheid te verlengen.

[Uitleg van Environmental Data](#) >

[Hoe evalueren we de duurzaamheid van producten?](#) >

Milieuoetafdruk

Totale levenscyclus ecologische voetafdruk 1

Milieuprofiel van product (PEP) [Milieuprofiel van het product](#)

Use Better

Materialen en verpakking

Pakket met gerecycleerd karton Ja

Verpakkingen zonder kunststof Ja

[EU-richtlijn RoHS](#)

Voldoet pro-actief (Product valt niet onder de EU RoHS juridische scope)

REACH-regelgeving

[REACH-verklaring](#)

Use Again

Herverpakken en herfabriceren

Circulair Profiel [Informatie over einde levensduur](#)

Terugname No

Dimensions Drawings

Dimensions

Without Boot

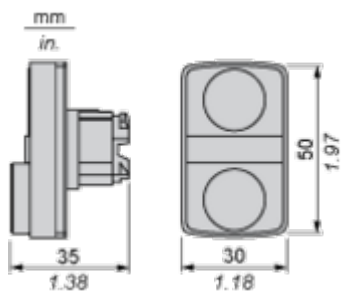

With Boot ZBA710

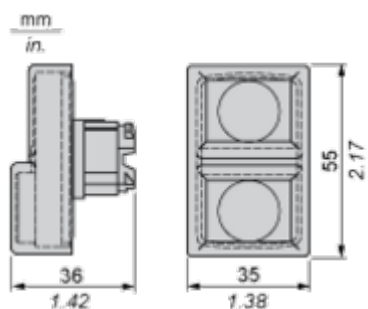

Mounting and Clearance

Panel Cut-out for Pushbuttons, Switches and Pilot Lights (Finished Holes, Ready for Installation)

Connection by Screw Clamp Terminals or Plug-in Connectors or on Printed Circuit Board	Connection by Faston Connectors
	
<p>(1) Diameter on finished panel or support (2) 40 mm min. / 1.57 in. min. (3) 30 mm min. / 1.18 in. min. (4) $\varnothing 22.5 \text{ mm} / 0.89 \text{ in.}$ recommended ($\varnothing 22.3 \text{ mm} \begin{smallmatrix} +0.4 \\ 0 \end{smallmatrix} / 0.88 \text{ in.} \begin{smallmatrix} +0.016 \\ 0 \end{smallmatrix}$) (5) 45 mm min. / 1.78 in. min. (6) 32 mm min. / 1.26 in. min.</p>	

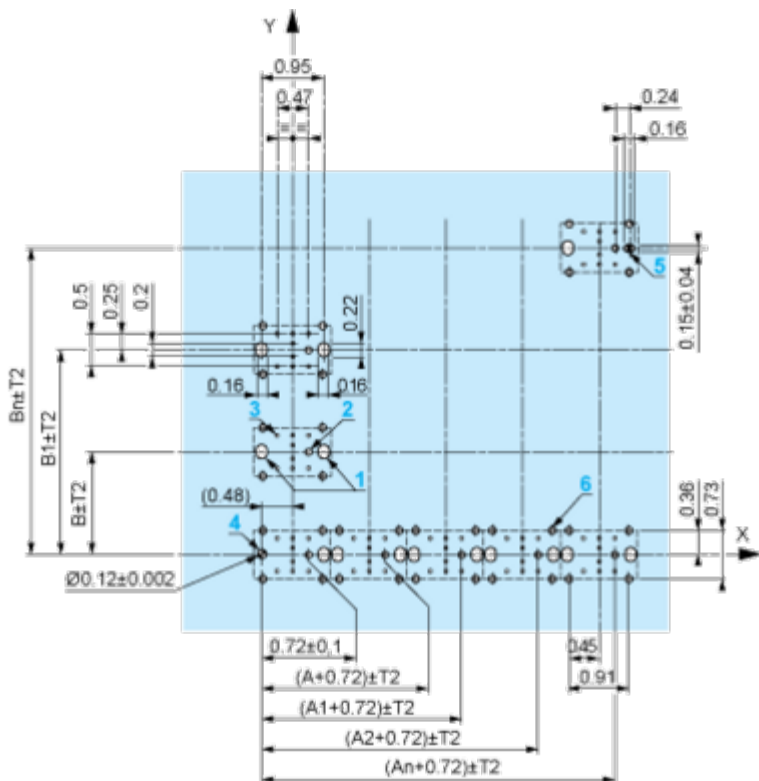

A: 1.18 in. min.
 B: 1.57 in. min.

General Tolerances of the Panel and Printed Circuit Board

The cumulative tolerance must not exceed 0.3 mm / 0.012 in: T1 + T2 = 0.3 mm max.

Installation Precautions

- Minimum thickness of circuit board: 1.6 mm / 0.06 in.
- Cut-out diameter: 22.4 mm ± 0.1 / 0.88 in. ± 0.004
- Orientation of body/fixing collar ZB4 BZ009: ± 2° 30' (excluding cut-outs marked a and b).
- Tightening torque of screws ZBZ 006: 0.6 N.m (5.3 lbf.in) max.
- Allow for one ZB4 BZ079 fixing collar/pillar and its fixing screws:
 - every 90 mm / 3.54 in. horizontally (X), and 120 mm / 4.72 in. vertically (Y).
 - with each selector switch head (ZB4 BD*, ZB4 BJ*, ZB4 BG*).

The fixing centers marked a and b are diagonally opposed and must align with those marked 4 and 5.



(1) Panel

(2) Printed circuit board

Mounting of Adapter (Socket) ZBZ 01

- 1 2 elongated holes for ZBZ 006 screw access
- 2 1 hole $\varnothing 2.4 \text{ mm} \pm 0.05 / 0.09 \text{ in.} \pm 0.002$ for centring adapter ZBZ 01
- 3 $8 \times \varnothing 1.2 \text{ mm} / 0.05 \text{ in.}$ holes
- 4 1 hole $\varnothing 2.9 \text{ mm} \pm 0.05 / 0.11 \text{ in.} \pm 0.002$, for aligning the printed circuit board (with cut-out marked a)
- 5 1 elongated hole for aligning the printed circuit board (with cut-out marked b)
- 6 4 holes $\varnothing 2.4 \text{ mm} / 0.09 \text{ in.}$ for clipping in adapter ZBZ 01

Dimensions An + 18.1 relate to the $\varnothing 2.4 \text{ mm} \pm 0.05 / 0.09 \text{ in.} \pm 0.002$ holes for centring adapter ZBZ 01.

Technical Description

Electrical Composition Corresponding to Code C3



Electrical Composition Corresponding to Code C4



Electrical Composition Corresponding to Codes C14, SF2 and SR2



Legend

Single contact



Double contact



Light block



Possible location



Technical Illustration

Dimensions

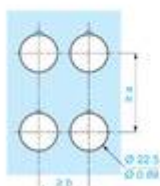
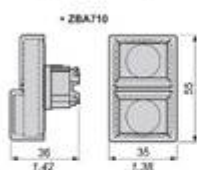
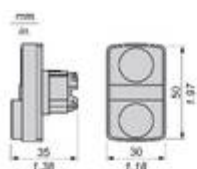





		a (mm)	a (in.)	b (mm)	b (in.)
		40	1.57	30	1.18
ZBE*****	ZB*****				
		45	1.77	32	1.26
ZBE*****3	ZB*****3				
		40	1.57	30	1.18
ZBE*****4	ZB*****4				
		50	1.97	30	1.18
ZBE*****5	ZB*****5				
		40	1.57	30	1.18
ZBE*****9	ZB*****9				
ZBR1*	ZBRV1	40	1.57	30	1.18

Offer Marketing Illustration

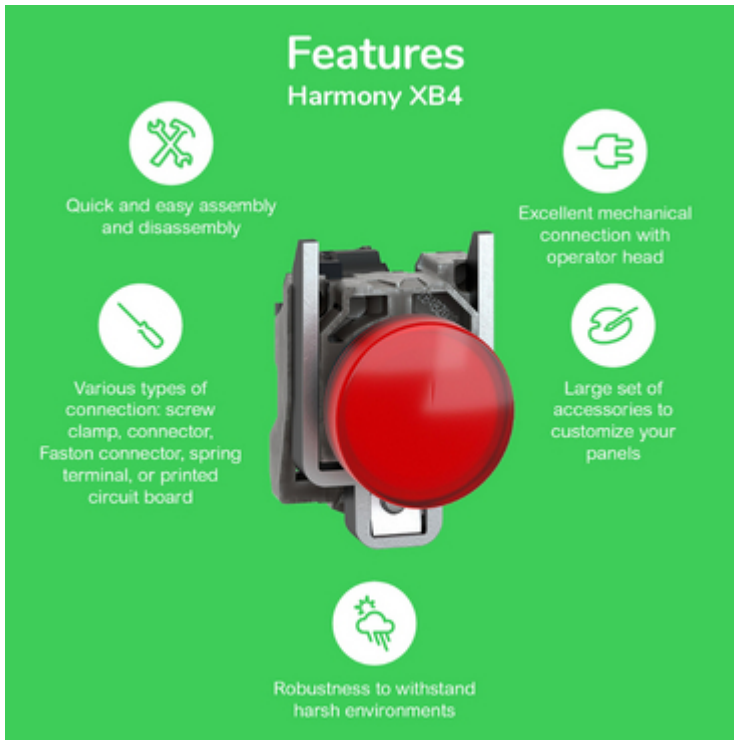
Product benefits / Features

Features Harmony XB4

-  Quick and easy assembly and disassembly
-  Excellent mechanical connection with operator head
-  Various types of connection: screw clamp, connector, Faston connector, spring terminal, or printed circuit board
-  Large set of accessories to customize your panels
-  Robustness to withstand harsh environments

Offer Marketing Illustration

Product benefits / Features

Technical Benefits

Harmony XB4

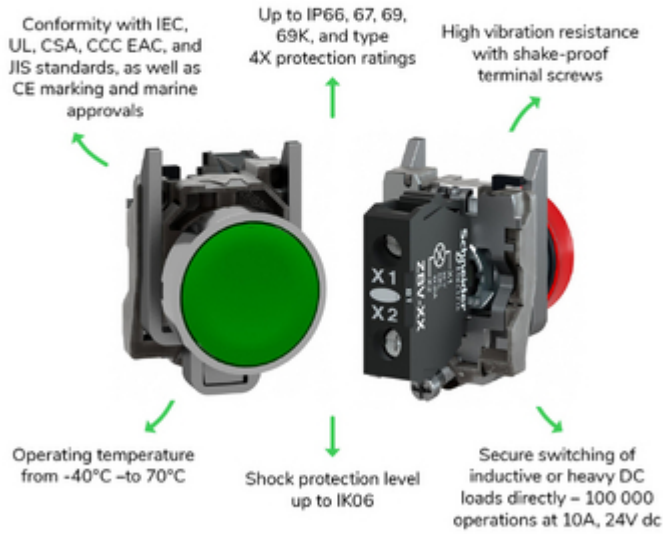

Image of product / Alternate images

Alternative

