









## IMO Bath spout for wall mounting - Chrome

IMO

13 801 670 Product version from 4/1/2024



- 200mm projection
- rectangular normal flow
- hole diameter 37 mm
- 1/2" connection
- max. flow 25.1 l/min at 3 bar flow pressure
- WRAS

	Chrome	13 801 670-00
	Brushed Platinum	13 801 670-06
	Dark Chrome	13 801 670-19
	Brushed Light Gold (PVD)	13 801 670-27
	Matte Black	13 801 670-33
	Brushed Gold (PVD)	13 801 670-37
	Brushed Chrome	13 801 670-93
	Brushed Dark Platinum	13 801 670-99

### Recommended miscellaneous



- Concealed wall elbow -** 35 085 970 90
- min. recess depth 90 mm
  - max. recess depth 163 mm

13 801 670 Product version from 4/1/2024

mm [inches]

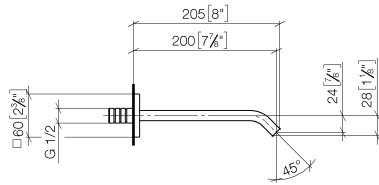

**Flow rate chart**

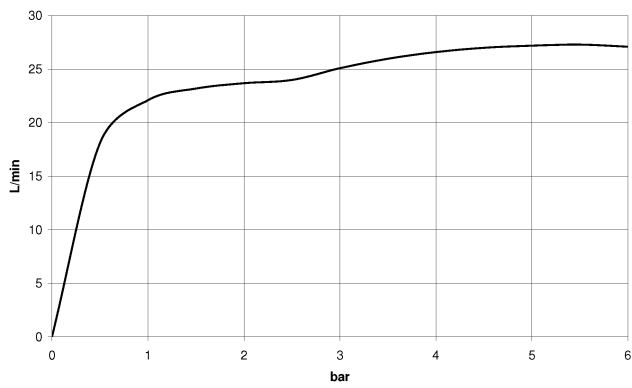

**Codes & Standards**

ASME A112.18.1

cUPC

Scottish Water  
Byelaws

UK Water Supply  
Regulations



## IMO Bath spout for wall mounting - Chrome

IMO

13 801 670 Product version from 4/1/2024

### Certificates and sustainability

IAPMO_4976	WRAS_2005	EPD-DOR-20230287 -IBA1-EN Environmental.prod uct-declarat
------------	-----------	--

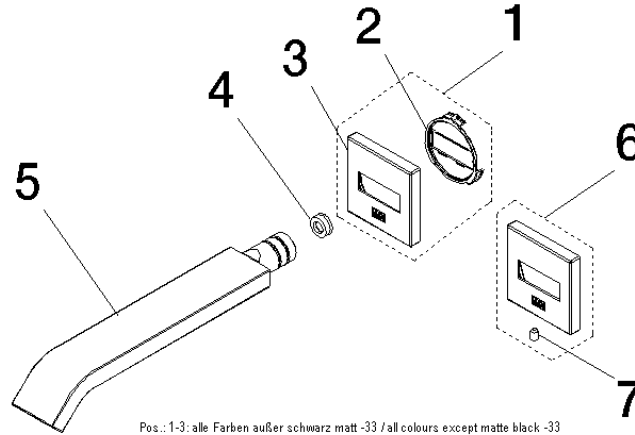

Pos.: 1-3: alle Farben außer schwarz matt -33 / all colours except matte black -33  
Pos.: 6-7: nur Farbe schwarz matt -33 / only colour matte black -33

## Spare parts list

No.	Item Number	Name	Quantity used	Delivery time
3	09 27 67 008-00	Rosette for wall spout 60 x 60 x 9 mm - Chrome	1.00	20
4	09 23 01 057 90	Flow limiter red 26,5 l/min. -	1.00	14
6	90 27 97 050 00-33	Rosette 60 x 60 x 9 mm - Matte Black	1.00	-
Spare part can no longer be ordered, please order the replacement item				
5	04 28 22 241 00-00	Spout 38 x 40 x 239 mm - Chrome	1.00	20
2	09 18 40 139 90	Holder 51x 6,5 x 51 mm -	1.00	14
1	90 27 67 008 00-00	Rosette 60 x 60 x 9 mm - Chrome	1.00	-
Spare part can no longer be ordered, please order the replacement item				
7	09 31 11 058 90	Mounting Threaded pin with hexagon socket with cup point M5 x 8 mm -	1.00	14