

## Data Sheet | Item Number: 2002-2218

Double-deck terminal block; Shield/through terminal block; 2.5 mm<sup>2</sup>; Shielding/N; without marker carrier; for DIN-rail 35 x 15 and 35 x 7.5; Push-in CAGE CLAMP®; 2,50 mm<sup>2</sup>; gray

<https://www.wago.com/2002-2218>

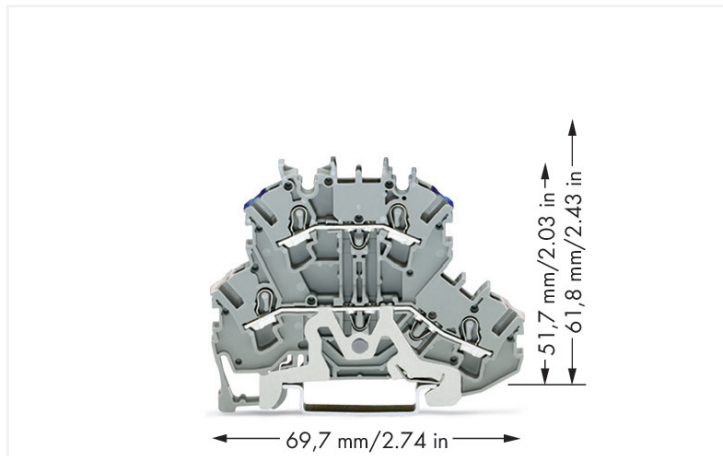

Color: ■ gray

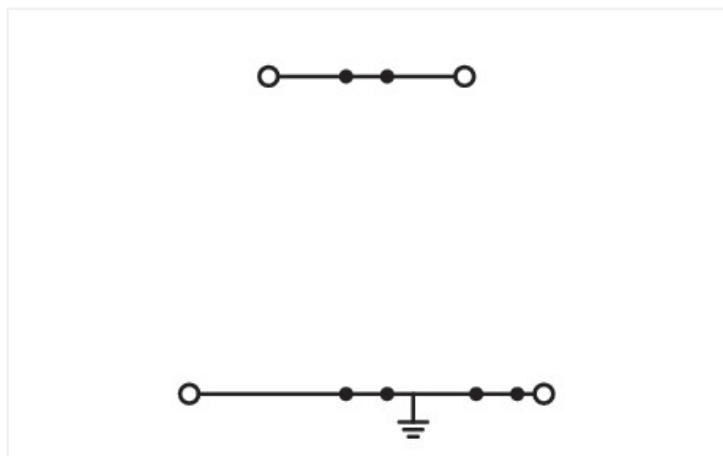

Similar to illustration

Double-deck terminal block, 2002 Series, Push-in CAGE CLAMP®

Enjoy effortless electrical installations with this double-deck terminal block (item number 2002-2218). Ensure that the strip lengths are between 10 and 12 mm when connecting conductors to this double-deck terminal block. The double-deck terminal block also functions as a shield terminal block as well as a through terminal block. This product features conductor terminals and utilizes Push-in CAGE CLAMP®. Push-in CAGE CLAMP® technology provides a universal connection solution for any type of conductor. It allows both solid and fine-stranded conductors with ferrules to be inserted directly into the clamping point without the need for tools. This double-deck terminal block is suitable for conductor cross sections ranging from 0.25 mm<sup>2</sup> to 4 mm<sup>2</sup>.

### Electrical data

Ratings per	IEC/EN 60947-7-1		
Overvoltage category	III	III	II
Pollution degree	3	2	2
Nominal voltage	500 V	-	-
Rated impulse withstand voltage	6 kV	-	-
Rated current	24 A	-	-

Ratings per	IEC/EN 60947-7-1		
Current at conductor cross-section (max.) mm <sup>2</sup>	28 A	-	-

Approvals per		UL 1059		
Use group		B	C	D
Rated voltage		300 V	300 V	600 V
Rated current		20 A	20 A	5 A

Approvals per		CSA 22.2 No 158		
Use group		B	C	D
Rated voltage		300 V	300 V	-
Rated current		20 A	20 A	-

Ex information	
Ratings per	ATEX: PTB 03 ATEX 1162 U / IECEx: PTB 03.0004U (Ex eb IIC Gb)
Rated voltage EN (Ex e II)	440 V
Rated current (Ex e II)	20 A
Rated current (Ex e II) with jumper	18 A

Power Loss	
Power loss, per pole (potential)	0.7661 W
Rated current $I_N$ for power loss specification	24 A
Resistance value for specified, current-dependent power loss	0.00133 $\Omega$

General information	
Wiring direction	Front-entry wiring

## Connection Data

Clamping units	4
Total number of potentials	2
Number of levels	2
Number of jumper slots	4

Connection 1	
Connection technology	Push-in CAGE CLAMP®
Number of connection points	2
Actuation type	Operating tool
Connectable conductor materials	Copper
Nominal cross-section	2.5 mm <sup>2</sup>
Solid conductor	0.25 ... 4 mm <sup>2</sup> / 22 ... 12 AWG
Solid conductor; push-in termination	0.75 ... 4 mm <sup>2</sup> / 18 ... 12 AWG
Fine-stranded conductor	0.25 ... 4 mm <sup>2</sup> / 22 ... 12 AWG
Fine-stranded conductor; with insulated ferrule	0.25 ... 2.5 mm <sup>2</sup> / 22 ... 14 AWG
Fine-stranded conductor; with ferrule; push-in termination	1 ... 2.5 mm <sup>2</sup> / 18 ... 14 AWG
Note (conductor cross-section)	Depending on the conductor characteristic, a conductor with a smaller cross-section can also be inserted via push-in termination.
Strip length	10 ... 12 mm / 0.39 ... 0.47 inches
Wiring direction	Front-entry wiring

Connection 2	
Number of connection points	2

## Physical data

Width	5.2 mm / 0.205 inches
Height	69.7 mm / 2.744 inches
Depth from upper-edge of DIN-rail	51.7 mm / 2.035 inches

### Mechanical data

Potential marking	Shield/N
Mounting type	DIN-35 rail
Marking level	Center/side marking

### Material data

Note (material data)	<a href="#">Information on material specifications can be found here</a>
Color	gray
Material group	I
Insulation material (main housing)	Polyamide (PA66)
Flammability class per UL94	V0
Fire load	0.197 MJ
Weight	13.1 g

### Environmental requirements

Processing temperature	-35 ... +85 °C	<b>Environmental Testing</b>
Continuous operating temperature	-60 ... +105 °C	
		Test specification: Railway applications – Rolling stock – Electronic equipment
		DIN EN 50155 (VDE 0115-200):2022-06
		Test procedure: Railway applications – Rolling stock equipment – Vibration and shock tests
		DIN EN 61373 (VDE 0115-0106):2011-04
		Spectrum/Mounting location
		Service life test, Category 1, Class A/B
		Functional test with noise-like oscillations
		Test passed according to Section 8 of the standard
		Frequency
		$f_1 = 5 \text{ Hz}$ to $f_2 = 150 \text{ Hz}$
		Acceleration
		0.101g (highest test level used for all axes)
		Test duration per axis
		10 min.
		Test directions
		X, Y and Z axes
		Monitoring of contact faults and interruptions
		Passed
		Voltage drop measurement before and after each axis
		Passed
		Simulated service life test through increased levels of noise-like oscillations
		Test passed according to Section 9 of the standard
		Frequency
		$f_1 = 5 \text{ Hz}$ to $f_2 = 150 \text{ Hz}$
		Acceleration
		0.572g (highest test level used for all axes)
		Test duration per axis
		5 h
		Test directions
		X, Y and Z axes
		Extended testing: Monitoring of contact faults and interruptions
		Passed
		Extended testing: Voltage drop measurement before and after each axis
		Passed
		Shock test
		Test passed according to Section 10 of the standard
		Shock pulse form
		Half sine
		Acceleration
		5g (highest test level used for all axes)
		Shock duration
		30 ms
		Number of shocks (per axis)
		3 pos. und 3 neg.
		Test directions
		X, Y and Z axes
		Extended testing: Monitoring of contact faults and interruptions
		Passed
		Extended testing: Voltage drop measurement before and after each axis
		Passed
		Vibration and shock stress for rolling stock equipment
		Passed

### Commercial data

Product Group	22 (TOPJOB S)
PU (SPU)	50 pcs
Packaging type	Box
Country of origin	DE
GTIN	4050821175155
Customs tariff number	85369010000

### Product Classification

UNSPSC	39121410
eCl@ss 10.0	27-14-11-41
eCl@ss 9.0	27-14-11-41
ETIM 9.0	EC000901
ETIM 10.0	EC000901
ECCN	NO US CLASSIFICATION

### Environmental Product Compliance

RoHS Compliance Status	Compliant, No Exemption
------------------------	-------------------------

### Approvals / Certificates

#### General approvals



Approval	Standard	Certificate Name
CCA DEKRA Certification B.V.	EN 60947	NTR NL-8054
CSA CSA Group	C22.2 No. 158	154112
DEKRA DEKRA Certification B.V.	EN 60947	71-149763
KEMA/KEUR DEKRA Certification B.V.	EN 60947	71-124163
UL Underwriters Laboratories Inc.	UL 1059	E45172

#### Declarations of conformity and manufacturer's declarations



Approval	Standard	Certificate Name
EU-Declaration of Conformity WAGO GmbH & Co. KG	-	-
Railway WAGO GmbH & Co. KG	-	Railway Ready
UK-Declaration of Conformity WAGO GmbH & Co. KG	-	-

### Approvals for marine applications



Approval	Standard	Certificate Name
ABS American Bureau of Shipping	EN 60947	24-0152298-PDA
DNV GL Det Norske Veritas, Germanischer Lloyd	-	TAE00001V2
PRS Polski Rejestr Statków	-	TE/1094/880590/23

**Downloads**

**Environmental Product Compliance**

**Compliance Search**

Environmental Product Compliance 2002-2218



**Documentation**

**Bid Text**

2002-2218	23.04.2019	xml 4.03 KB	
2002-2218	23.04.2019	docx 15.06 KB	

**CAD/CAE-Data**

**CAD data**

2D/3D Models  
2002-2218



**CAE data**

EPLAN Data Portal  
2002-2218



WSCAD Universe  
2002-2218



ZUKEN Portal  
2002-2218



**1 Compatible Products**

**1.1 Required Accessories**

**1.1.1 End plate**

**1.1.1.1 End plate**



**Item No.: 2002-2291**

End and intermediate plate; 0.8 mm thick; gray

**Item No.: 2002-2292**

End and intermediate plate; 0.8 mm thick; orange

**Item No.: 209-192**

Separator for Ex e/Ex i applications; 3 mm thick; 125.5 mm wide; orange

**Item No.: 2002-2295**

Separator plate; oversized upper deck; snap-fit type; 2 mm thick; gray



**Item No.: 2002-2296**

Separator plate; oversized upper deck; snap-fit type; 2 mm thick; orange

## 1.2 Optional Accessories

### 1.2.1 DIN-rail

#### 1.2.1.1 Mounting accessories



**Item No.: 210-196**

Aluminum carrier rail; 35 x 8.2 mm; 1.6 mm thick; 2 m long; unslotted; similar to EN 60715; silver-colored



**Item No.: 210-198**

Copper carrier rail; 35 x 15 mm; 2.3 mm thick; 2 m long; unslotted; according to EN 60715; copper-colored



**Item No.: 210-508**

Steel carrier rail; 35 x 15 mm; 1.5 mm thick; 2 m long; slotted; galvanized; similar to EN 60715; silver-colored



**Item No.: 210-197**

Steel carrier rail; 35 x 15 mm; 1.5 mm thick; 2 m long; slotted; similar to EN 60715; silver-colored



**Item No.: 210-506**

Steel carrier rail; 35 x 15 mm; 1.5 mm thick; 2 m long; unslotted; galvanized; similar to EN 60715; silver-colored



**Item No.: 210-114**

Steel carrier rail; 35 x 15 mm; 1.5 mm thick; 2 m long; unslotted; similar to EN 60715; silver-colored



**Item No.: 210-118**

Steel carrier rail; 35 x 15 mm; 2.3 mm thick; 2 m long; unslotted; according to EN 60715; silver-colored



**Item No.: 210-115**

Steel carrier rail; 35 x 7.5 mm; 1 mm thick; 2 m long; slotted; according to EN 60715; "Hole width 18 mm; silver-colored



**Item No.: 210-112**

Steel carrier rail; 35 x 7.5 mm; 1 mm thick; 2 m long; slotted; according to EN 60715; "Hole width 25 mm; silver-colored



**Item No.: 210-504**

Steel carrier rail; 35 x 7.5 mm; 1 mm thick; 2 m long; slotted; galvanized; according to EN 60715; silver-colored



**Item No.: 210-113**

Steel carrier rail; 35 x 7.5 mm; 1 mm thick; 2 m long; unslotted; according to EN 60715; silver-colored



**Item No.: 210-505**

Steel carrier rail; 35 x 7.5 mm; 1 mm thick; 2 m long; unslotted; galvanized; according to EN 60715; silver-colored

### 1.2.2 Ferrule

#### 1.2.2.1 Ferrule



**Item No.: 216-241**

Ferrule; Sleeve for 0.5 mm<sup>2</sup> / 20 AWG; insulated; electro-tin plated; electrolytic copper; gastight crimped; acc. to DIN 46228, Part 4/09.90; white



**Item No.: 216-242**

Ferrule; Sleeve for 0.75 mm<sup>2</sup> / 18 AWG; insulated; electro-tin plated; electrolytic copper; gastight crimped; acc. to DIN 46228, Part 4/09.90; gray



**Item No.: 216-262**

Ferrule; Sleeve for 0.75 mm<sup>2</sup> / 18 AWG; insulated; electro-tin plated; electrolytic copper; gastight crimped; acc. to DIN 46228, Part 4/09.90; gray



**Item No.: 216-243**

Ferrule; Sleeve for 1 mm<sup>2</sup> / AWG 18; insulated; electro-tin plated; electrolytic copper; gastight crimped; acc. to DIN 46228, Part 4/09.90; red



**Item No.: 216-263**

Ferrule; Sleeve for 1 mm<sup>2</sup> / AWG 18; insulated; electro-tin plated; electrolytic copper; gastight crimped; acc. to DIN 46228, Part 4/09.90; red



**Item No.: 216-244**

Ferrule; Sleeve for 1.5 mm<sup>2</sup> / AWG 16; insulated; electro-tin plated; electrolytic copper; gastight crimped; acc. to DIN 46228, Part 4/09.90; black



**Item No.: 216-264**

Ferrule; Sleeve for 1.5 mm<sup>2</sup> / AWG 16; insulated; electro-tin plated; electrolytic copper; gastight crimped; acc. to DIN 46228, Part 4/09.90; black



**Item No.: 216-246**

Ferrule; Sleeve for 2.5 mm<sup>2</sup> / AWG 14; insulated; electro-tin plated; electrolytic copper; gastight crimped; acc. to DIN 46228, Part 4/09.90; blue



**Item No.: 216-266**

Ferrule; Sleeve for 2.5 mm<sup>2</sup> / AWG 14; insulated; electro-tin plated; electrolytic copper; gastight crimped; acc. to DIN 46228, Part 4/09.90; blue

### 1.2.3 Installation

#### 1.2.3.1 Cover



**Item No.: 709-156**

Cover; Type 3; suitable for cover carrier, type 3; 1 m long; transparent

1.2.3.2 Cover carrier



**Item No.: 709-169**

Cover carrier; Type 3; incl. fixing/retaining screws and knurled nut; suitable for 279 to 282 and 880 Series rail-mounted terminal blocks; suitable for 264 Series miniature rail-mounted terminal blocks; suitable for 270 Series sensor and actuator terminal blocks; gray

1.2.4 Insulation stop

1.2.4.1 Insulation stop



**Item No.: 2002-171**

Insulation stop; 0.25 - 0.5 mm<sup>2</sup>; 5 pieces/strip; light gray



**Item No.: 2002-172**

Insulation stop; 0.75 - 1 mm<sup>2</sup>; 5 pieces/strip; dark gray

1.2.5 Jumper

1.2.5.1 Jumper



**Item No.: 2002-400**

Continuous jumper; 2-way; insulated; light gray



**Item No.: 2002-413**

Continuous jumper; 3-way; insulated; light gray



**Item No.: 2002-415**

Continuous jumper; 5-way; insulated; light gray



**Item No.: 2002-423/000-006**

Continuous jumper; from 1 to 3; insulated; blue



**Item No.: 2002-423**

Continuous jumper; from 1 to 3; insulated; light gray



**Item No.: 2002-423/000-005**

Continuous jumper; from 1 to 3; insulated; red



**Item No.: 2002-424/000-006**

Continuous jumper; from 1 to 4; insulated; blue



**Item No.: 2002-424**

Continuous jumper; from 1 to 4; insulated; light gray



**Item No.: 2002-424/000-005**

Continuous jumper; from 1 to 4; insulated; red



**Item No.: 2002-406/020-000**

Delta jumper; insulated; light gray



**Item No.: 2002-410/000-006**

Jumper; 10-way; insulated; blue



**Item No.: 2002-410**

Jumper; 10-way; insulated; light gray



**Item No.: 2002-410/000-005**

Jumper; 10-way; insulated; red



**Item No.: 2002-402/000-006**

Jumper; 2-way; insulated; blue



**Item No.: 2002-402**

Jumper; 2-way; insulated; light gray



**Item No.: 2002-402/000-005**

Jumper; 2-way; insulated; red



**Item No.: 2002-403/000-006**

Jumper; 3-way; insulated; blue



**Item No.: 2002-403**

Jumper; 3-way; insulated; light gray



**Item No.: 2002-403/000-005**

Jumper; 3-way; insulated; red



**Item No.: 2002-404/000-006**

Jumper; 4-way; insulated; blue



**Item No.: 2002-404**

Jumper; 4-way; insulated; light gray



**Item No.: 2002-404/000-005**

Jumper; 4-way; insulated; red



**Item No.: 2002-405/000-006**

Jumper; 5-way; insulated; blue



**Item No.: 2002-405**

Jumper; 5-way; insulated; light gray



**Item No.: 2002-405/000-005**

Jumper; 5-way; insulated; red



**Item No.: 2002-406/000-006**

Jumper; 6-way; insulated; blue



**Item No.: 2002-406**

Jumper; 6-way; insulated; light gray



**Item No.: 2002-406/000-005**

Jumper; 6-way; insulated; red



**Item No.: 2002-407/000-006**

Jumper; 7-way; insulated; blue



**Item No.: 2002-407**

Jumper; 7-way; insulated; light gray



**Item No.: 2002-407/000-005**

Jumper; 7-way; insulated; red



**Item No.: 2002-408/000-006**

Jumper; 8-way; insulated; blue



**Item No.: 2002-408**

Jumper; 8-way; insulated; light gray



**Item No.: 2002-408/000-005**

Jumper; 8-way; insulated; red



**Item No.: 2002-409/000-006**































Jumper; 9-way; insulated; blue



**Item No.: 2002-409**



Jumper; 9-way; insulated; light gray

1.2.5.1 Jumper









 <b>Item No.: 2002-409/000-005</b> Jumper; 9-way; insulated; red	 <b>Item No.: 2002-440</b> Jumper; from 1 to 10; insulated; light gray	 <b>Item No.: 2002-433</b> Jumper; from 1 to 3; insulated; light gray	 <b>Item No.: 2002-434</b> Jumper; from 1 to 4; insulated; light gray
 <b>Item No.: 2002-435</b> Jumper; from 1 to 5; insulated; light gray	 <b>Item No.: 2002-436</b> Jumper; from 1 to 6; insulated; light gray	 <b>Item No.: 2002-437</b> Jumper; from 1 to 7; insulated; light gray	 <b>Item No.: 2002-438</b> Jumper; from 1 to 8; insulated; light gray
 <b>Item No.: 2002-439</b> Jumper; from 1 to 9; insulated; light gray	 <b>Item No.: 2002-480</b> Staggered jumper; 10-way; insulated; light gray	 <b>Item No.: 2002-481</b> Staggered jumper; 11-way; insulated; light gray	 <b>Item No.: 2002-482</b> Staggered jumper; 12-way; insulated; light gray
 <b>Item No.: 2002-473/011-000</b> Staggered jumper; 2-way; from 1 to 3; insulated; light gray	 <b>Item No.: 2002-472</b> Staggered jumper; 2-way; insulated; light gray	 <b>Item No.: 2002-473</b> Staggered jumper; 3-way; insulated; light gray	 <b>Item No.: 2002-475/011-000</b> Staggered jumper; 3-way; insulated; light gray
 <b>Item No.: 2002-474</b> Staggered jumper; 4-way; insulated; light gray	 <b>Item No.: 2002-475</b> Staggered jumper; 5-way; insulated; light gray	 <b>Item No.: 2002-476</b> Staggered jumper; 6-way; insulated; light gray	 <b>Item No.: 2002-477</b> Staggered jumper; 7-way; insulated; light gray
 <b>Item No.: 2002-478</b> Staggered jumper; 8-way; insulated; light gray	 <b>Item No.: 2002-479</b> Staggered jumper; 9-way; insulated; light gray	 <b>Item No.: 2002-477/011-000</b> Staggered jumper; insulated; light gray	 <b>Item No.: 2002-479/011-000</b> Staggered jumper; insulated; light gray
 <b>Item No.: 2002-481/011-000</b> Staggered jumper; insulated; light gray	 <b>Item No.: 2002-405/011-000</b> Star point jumper; 3-way; insulated; light gray	 <b>Item No.: 2002-492</b> Vertical jumper; insulated; light gray	 <b>Item No.: 2002-492/000-012</b> Vertical jumper; insulated; orange
 <b>Item No.: 210-103</b> Wire commoning chain; insulated; black	 <b>Item No.: 210-123</b> Wire commoning chain; insulated; blue		

1.2.6 Marking

1.2.6.1 Group marker carrier

 <b>Item No.: 2009-191</b> Group marker carrier; gray	 <b>Item No.: 2009-192</b> Group marker carrier; gray	 <b>Item No.: 2009-193</b> Group marker carrier; gray
--	--	---

1.2.6.2 Marker

 <b>Item No.: 2009-145/000-006</b> Mini-WSB Inline; for Smart Printer; 1700 pieces on roll; stretchable 5 - 5.2 mm; plain; snap-on type; blue	 <b>Item No.: 2009-145/000-007</b> Mini-WSB Inline; for Smart Printer; 1700 pieces on roll; stretchable 5 - 5.2 mm; plain; snap-on type; gray	 <b>Item No.: 2009-145/000-023</b> Mini-WSB Inline; for Smart Printer; 1700 pieces on roll; stretchable 5 - 5.2 mm; plain; snap-on type; green	 <b>Item No.: 2009-145/000-012</b> Mini-WSB Inline; for Smart Printer; 1700 pieces on roll; stretchable 5 - 5.2 mm; plain; snap-on type; orange
 <b>Item No.: 2009-145/000-005</b> Mini-WSB Inline; for Smart Printer; 1700 pieces on roll; stretchable 5 - 5.2 mm; plain; snap-on type; red	 <b>Item No.: 2009-145/000-024</b> Mini-WSB Inline; for Smart Printer; 1700 pieces on roll; stretchable 5 - 5.2 mm; plain; snap-on type; violet	 <b>Item No.: 2009-145</b> Mini-WSB Inline; for Smart Printer; 1700 pieces on roll; stretchable 5 - 5.2 mm; plain; snap-on type; white	 <b>Item No.: 2009-145/000-002</b> Mini-WSB Inline; for Smart Printer; 1700 pieces on roll; stretchable 5 - 5.2 mm; plain; snap-on type; yellow

1.2.6.2 Marker



**Item No.: 248-501/000-006**  
Mini-WSB marking card; as card; not stretchable; plain; snap-on type; blue



**Item No.: 248-501/000-007**  
Mini-WSB marking card; as card; not stretchable; plain; snap-on type; gray



**Item No.: 248-501/000-023**  
Mini-WSB marking card; as card; not stretchable; plain; snap-on type; green



**Item No.: 248-501/000-017**  
Mini-WSB marking card; as card; not stretchable; plain; snap-on type; light green



**Item No.: 248-501/000-012**  
Mini-WSB marking card; as card; not stretchable; plain; snap-on type; orange



**Item No.: 248-501/000-005**  
Mini-WSB marking card; as card; not stretchable; plain; snap-on type; red



**Item No.: 248-501/000-024**  
Mini-WSB marking card; as card; not stretchable; plain; snap-on type; violet



**Item No.: 248-501**  
Mini-WSB marking card; as card; not stretchable; plain; snap-on type; white



**Item No.: 248-501/000-002**  
Mini-WSB marking card; as card; not stretchable; plain; snap-on type; yellow



**Item No.: 793-5501/000-006**  
WMB marking card; as card; for terminal block width 5 - 17.5 mm; stretchable 5 - 5.2 mm; plain; snap-on type; blue



**Item No.: 793-5501/000-014**  
WMB marking card; as card; for terminal block width 5 - 17.5 mm; stretchable 5 - 5.2 mm; plain; snap-on type; brown



**Item No.: 793-5501/000-007**  
WMB marking card; as card; for terminal block width 5 - 17.5 mm; stretchable 5 - 5.2 mm; plain; snap-on type; gray



**Item No.: 793-5501/000-023**  
WMB marking card; as card; for terminal block width 5 - 17.5 mm; stretchable 5 - 5.2 mm; plain; snap-on type; green



**Item No.: 793-5501/000-017**  
WMB marking card; as card; for terminal block width 5 - 17.5 mm; stretchable 5 - 5.2 mm; plain; snap-on type; light green



**Item No.: 793-5501/000-012**  
WMB marking card; as card; for terminal block width 5 - 17.5 mm; stretchable 5 - 5.2 mm; plain; snap-on type; orange



**Item No.: 793-5501/000-005**  
WMB marking card; as card; for terminal block width 5 - 17.5 mm; stretchable 5 - 5.2 mm; plain; snap-on type; red



**Item No.: 793-5501/000-024**  
WMB marking card; as card; for terminal block width 5 - 17.5 mm; stretchable 5 - 5.2 mm; plain; snap-on type; violet



**Item No.: 793-5501**  
WMB marking card; as card; for terminal block width 5 - 17.5 mm; stretchable 5 - 5.2 mm; plain; snap-on type; white



**Item No.: 793-5501/000-002**  
WMB marking card; as card; for terminal block width 5 - 17.5 mm; stretchable 5 - 5.2 mm; plain; snap-on type; yellow



**Item No.: 2009-115/000-006**  
WMB-Inline; for Smart Printer; 1500 pieces on roll; stretchable 5 - 5.2 mm; plain; snap-on type; blue



**Item No.: 2009-115/000-007**  
WMB-Inline; for Smart Printer; 1500 pieces on roll; stretchable 5 - 5.2 mm; plain; snap-on type; gray



**Item No.: 2009-115/000-023**  
WMB-Inline; for Smart Printer; 1500 pieces on roll; stretchable 5 - 5.2 mm; plain; snap-on type; green



**Item No.: 2009-115/000-017**  
WMB-Inline; for Smart Printer; 1500 pieces on roll; stretchable 5 - 5.2 mm; plain; snap-on type; light green



**Item No.: 2009-115/000-012**  
WMB-Inline; for Smart Printer; 1500 pieces on roll; stretchable 5 - 5.2 mm; plain; snap-on type; orange



**Item No.: 2009-115/000-005**  
WMB-Inline; for Smart Printer; 1500 pieces on roll; stretchable 5 - 5.2 mm; plain; snap-on type; red



**Item No.: 2009-115/000-024**  
WMB-Inline; for Smart Printer; 1500 pieces on roll; stretchable 5 - 5.2 mm; plain; snap-on type; violet



**Item No.: 2009-115**  
WMB-Inline; for Smart Printer; 1500 pieces on roll; stretchable 5 - 5.2 mm; plain; snap-on type; white



**Item No.: 2009-115/000-002**  
WMB-Inline; for Smart Printer; 1500 pieces on roll; stretchable 5 - 5.2 mm; plain; snap-on type; yellow

1.2.6.3 Marker carrier



**Item No.: 2002-121**  
Adaptor; gray



**Item No.: 2002-161**  
Adaptor; gray



**Item No.: 2009-198**  
Adaptor; gray

1.2.6.4 Marking strip



**Item No.: 2009-110**  
Marking strips; for Smart Printer; on reel; not stretchable; plain; snap-on type; white

## 1.2.7 Protective warning marker

### 1.2.7.1 Cover



**Item No.: 2002-115**

Protective warning marker; for 5 terminal blocks; with high-voltage symbol, black; yellow

## 1.2.8 Push-in type wire jumper

### 1.2.8.1 Jumper



**Item No.: 2009-414**

Push-in type wire jumper; 1.5 mm²; insulated; 110 mm long; black



**Item No.: 2009-414/000-005**

Push-in type wire jumper; 1.5 mm²; insulated; 110 mm long; black



**Item No.: 2009-416**

Push-in type wire jumper; 1.5 mm²; insulated; 250 mm long; black



**Item No.: 2009-414/000-006**

Push-in type wire jumper; insulated; 110 mm long; black



**Item No.: 2009-412**

Push-in type wire jumper; insulated; 60 mm long; black

## 1.2.9 Screwless end stop

### 1.2.9.1 Mounting accessories



**Item No.: 249-117**

Screwless end stop; 10 mm wide; for DIN-rail 35 x 15 and 35 x 7.5; gray



**Item No.: 249-116**

Screwless end stop; 6 mm wide; for DIN-rail 35 x 15 and 35 x 7.5; gray

## 1.2.10 Test and measurement

### 1.2.10.1 Testing accessories



**Item No.: 2009-174**

Test plug adapter; for 4 mm Ø test plugs; for testing TOPJOB®S rail-mounted terminal blocks; gray



**Item No.: 2009-182**

Testing tap; for max. 2.5 mm²; tool-free connection for individual test wires 0.08 - 2.5 mm; gray



**Item No.: 2002-649**

TOPJOB®S L-type spacer module; modular; e.g., for bridging commoned terminal blocks; gray



**Item No.: 2002-611**

TOPJOB®S L-type test plug module; modular; 1-pole; gray

## 1.2.11 Tool

### 1.2.11.1 Operating tool



**Item No.: 210-658**

Operating tool; Blade: 3.5 x 0.5 mm; with a partially insulated shaft; angled; short; multicoloured



**Item No.: 210-720**

Operating tool; Blade: 3.5 x 0.5 mm; with a partially insulated shaft; multicoloured

## Installation Notes

### Conductor termination



All conductor types at a glance

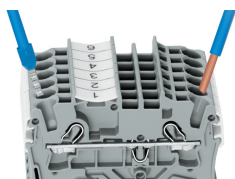

Push-in termination of solid and ferruled conductors

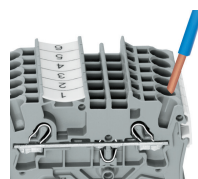

**Inserting a conductor via push-in termination:**  
Solid conductors with cross-sections from either one size above, or up to two sizes below, the rated cross-section can be simply pushed in – no tools needed.

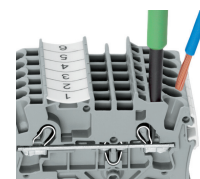

**Inserting a conductor via operating tool:**  
Connecting fine-stranded conductors without ferrules, or small cross-sectional conductors that cannot be pushed in, is performed similarly to the original CAGE CLAMP® – just use an operating tool.  
**Advantage:**  
To open the clamp, the operating tool is inserted vertically. The conductor entry is less than 15 degrees for easier wiring.

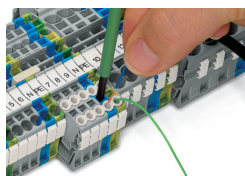

Conductor termination – insulation stop

### Commoning

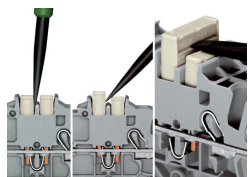

**Removing a push-in type jumper bar:**  
Insert the operating tool between the jumper and partition wall of the dual jumper slots, then lift up the jumper.  
Place the operating tool in the center of jumpers for up to five contacts (see above), or alternately on both sides for jumpers with more than five contacts.

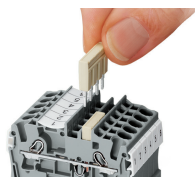

Insert push-in type jumper bar and push down until it hits backstop.

### Commoning

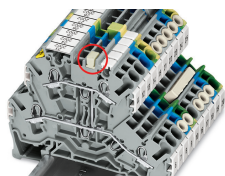

Commoning two levels via double-deck vertical jumper (2002-492).

## Marking

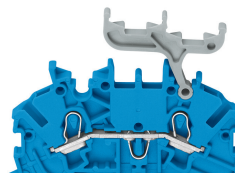
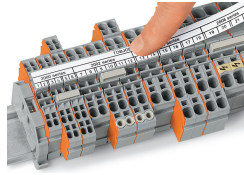
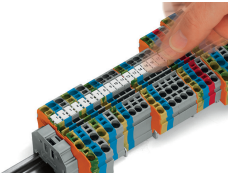

Snapping WMB Inline markers into marker slots.

### Double-deck terminal blocks

A double-deck marker carrier (2002-121) can be retrofitted to double-deck terminal blocks without a marker carrier.

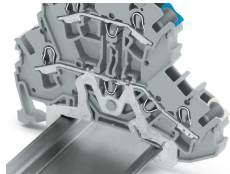

Both ground and shield conductor terminal blocks have a contact foot in the bottom level, automatically establishing direct contact to the DIN-rail or busbar.

The flexible double-deck marker carrier, which is placed above the wiring level, can be pushed aside during wiring. The carrier has two staggered levels for WMB markers that perfectly align with the terminal block decks.

With a terminal block width of just 5.2 mm, an effective width of just 2.6 mm for terminal blocks of same or different potentials can be realized for conductors ranging 0.25 mm<sup>2</sup> ... 4 mm<sup>2</sup> (22 ... 12 AWG).

Shielded control cables are becoming an increasingly common solution to external signal interference.

Front-entry shield conductor terminal blocks are ideal for connecting braided cables. Like front-entry ground conductor terminal blocks, they are equipped with a grounding foot for direct electrical connection to the rail, however they differ significantly by their white insulated housing. Shield conductor terminal blocks for front-entry wiring can be directly mounted beside signal-conductor terminal blocks, providing excellent deflection of interfering signals.