

Data Sheet | Item Number: 2092-1603/002-000

Gripping plate with sliding connector release; for female and male connectors; 2 parts; Pin spacing 5 mm; light gray

<https://www.wago.com/2092-1603/002-000>

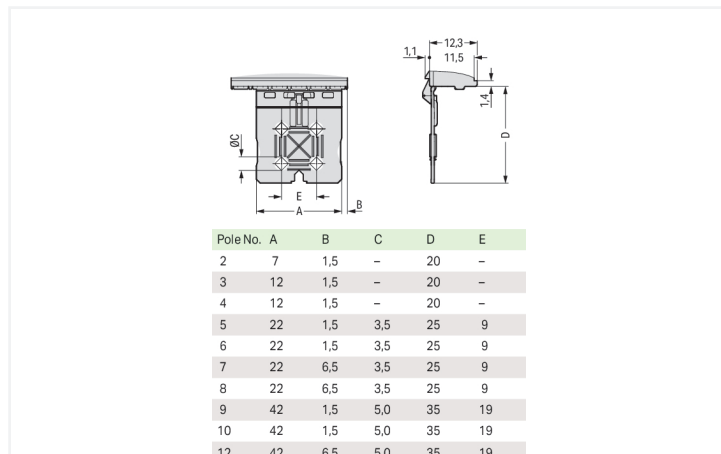

Color: ■ light gray

Similar to illustration

Dimensions in mm

Physical data

Pin spacing	5 mm / 0.197 inches
Width	42 mm

Mechanical data

Design	with sliding connector release
--------	--------------------------------

Material data

Note (material data)	Information on material specifications can be found here
Color	light gray
Fire load	0.042 MJ
Weight	1.4 g

Commercial data

PU (SPU)	100 (25) pcs
Packaging type	Box
Country of origin	DE
GTIN	4050821445906
Customs tariff number	85389099990

Product Classification

UNSPSC	39121421
eCl@ss 10.0	27-14-11-92
eCl@ss 9.0	27-14-11-92
ETIM 9.0	EC002848
ETIM 10.0	EC002848
ECCN	NO US CLASSIFICATION

Environmental Product Compliance

RoHS Compliance Status	Compliant, No Exemption
------------------------	-------------------------

Downloads

Environmental Product Compliance

Compliance Search

Environmental Product Compliance 2092-1603/002-000	↓
---	---

Documentation

Additional Information

Technical Section	03.04.2019	pdf 2027.26 KB	↓
-------------------	------------	-------------------	---

Installation Notes

Strain relief

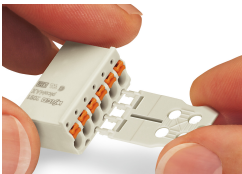

Gripping plates are suitable for factory and field assembly.