

PKZ circuit breakers
DIL contactors

MOELLER
SERIES



WIN-WIN with Push-in: PKZ & DIL

Product overview Push-in technology

EATON

Powering Business Worldwide

PKZ & DIL, the win-win effect: faster and more cost-effective at the same time

Eaton's Moeller series xStart range is being upgraded with Push-in technology. This new tool-free connection technology makes wiring even faster, safer and more efficient. The PKZ and DIL solution with Push-in technology offers maximum reliability, can be used anywhere in the world and integrates seamlessly into existing control panel designs.

Trusted technology just got even better.

Eaton has more than 100 years of experience and extensive know-how in the field of motor protection and contactors. Since we launched the xStart range in 2004, we have sold more than 100 million units. No one else has more experience and expertise in this field.

Like the rest of the xStart modular system, the products with Push-in technology are developed in Germany and approved for global use.

Who needs screws? The trick with the click.

The Push-in terminals enable safe and easy control-panel wiring with just one click. With our modular system and wide range of accessories, you'll always find the right solution for your application.

Thanks to their compact, space-saving size, the devices can be easily integrated into existing control cabinet designs.

Combining new technology and proven wiring concepts.

Our Push-in range even includes devices that combine screw and Push-in terminals for use with a 3-phase busbar link.

To sum up, the Push-in technology makes your work noticeably easier! Integrating the devices into existing systems is easy and cost-effective - anywhere in the world.



DILA contactor relay
DILM7 contactor



DILM17 contactors



Motor-protective circuit breaker



Future-proof your control panel the simple way - with Eaton's Push-in range.

Technicians and purchasers alike love the new xStart range. Wiring has never been more efficient, thanks to Eaton's tried and tested PKZ and DIL range and our cutting-edge push-in technology, which eliminates the need for tools. You too can benefit from this win-win effect by future-proofing your control panel the simple way.

Eaton.com/win-win

Interested? Find out more



Eaton.com/win-win



Future-proof your control panel the simple way - with xStart.

Eaton has been developing motor starters for over 100 years and our products are used around the world. From the beginning, our ideas and innovations have made a major contribution to advances in motor protection and switching. Given our long tradition in the field, we've turned motor protection into one of our core areas of expertise, which we continue to develop to this day.

xStart system overview

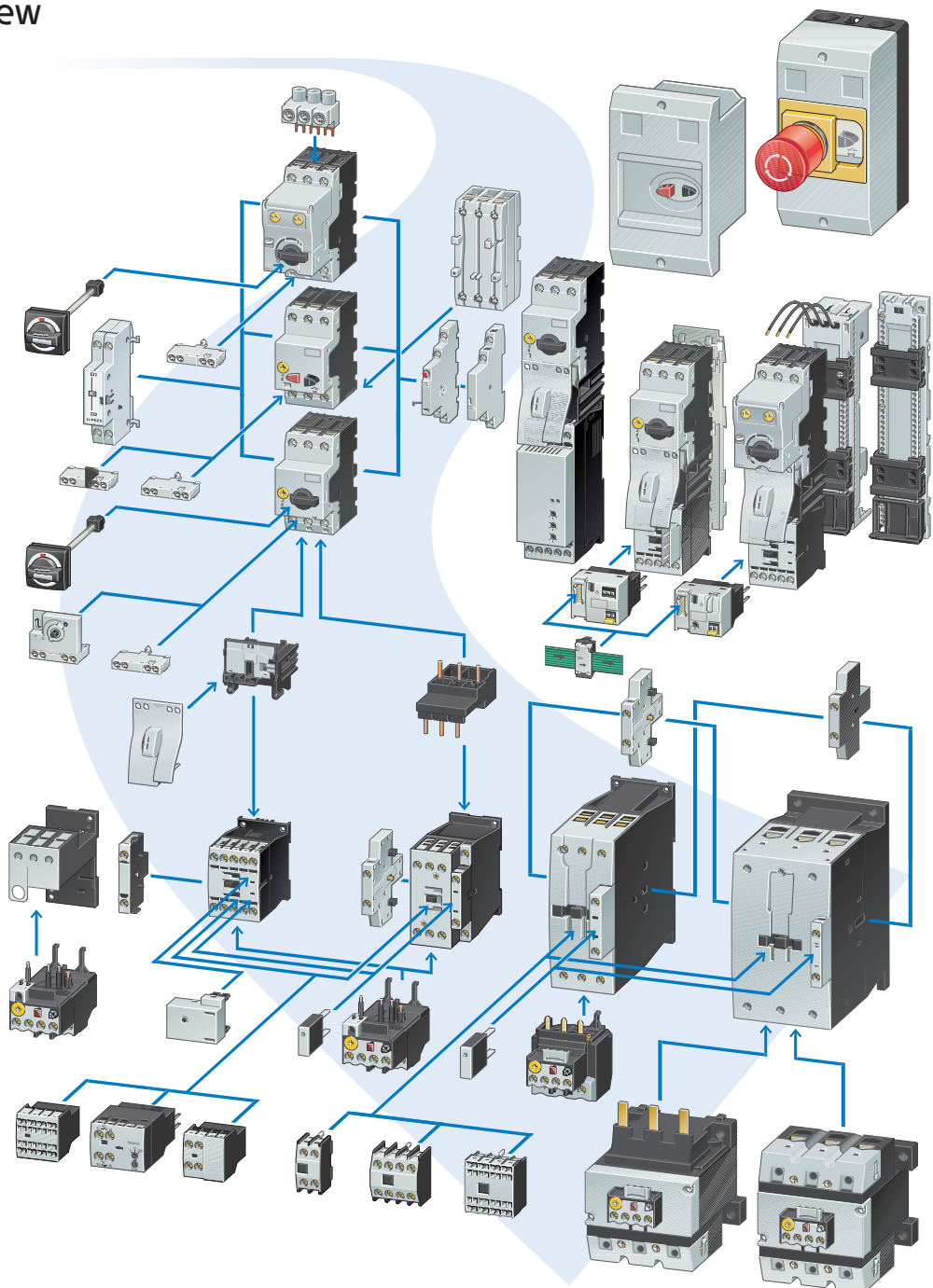

System expansion with Push-in technology

Simplify & optimize the installation and design of your machines and systems by using Eaton's tool-free Push-in technology, which can be used anywhere in the world without restrictions.

With the simplified wiring process, establishing the connection is up to 50 % faster (compared to screw terminals), thereby increasing the competitiveness of your products.

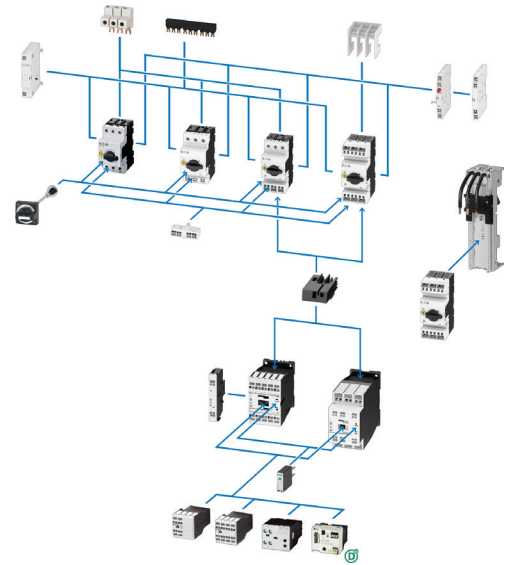

The Moeller series - a 100-year legacy

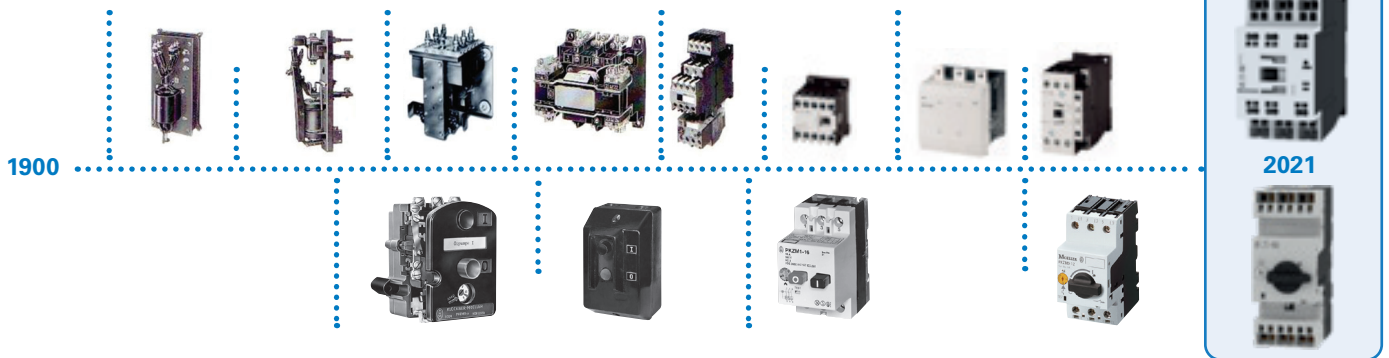

User-friendly

Faster commissioning

- Tool-free installation
- Simplified installation thanks to the easy Push-in technology
- Time savings of 50 % compared to screw terminals



Future-proof connection

A future-proof wiring system

- Using the next generation of cage clamp terminals
- Can be automatically installed by robots



Availability

Improved machines and systems

- High level of vibration and shock resistance, i.e. no need to retighten the cable connections after transport, immediately ready for use
- Maintenance-free over the entire service life



Seamless integration

Easy integration

- No need to adapt the control panel design
- Screw-/Push-in combination device for use with a 3-phase busbar link

DIL contactors



The DIL contactors are powerful, efficient and versatile and can be combined with our entire product range. The DIL contactors are suitable for global use and cover the entire output range, from mini contactor relays (up to 7 A) all the way to vacuum contactors (up to 3,180 A).

Through the expansion of our product range and the use of the new Push-in technology we've made wiring even easier, faster and safer.

We've extended the rated current of the contactors with Push-in connection technology to 38 A (AC-3), and they can be controlled remotely via SmartWire-DT.

Protecting and switching IE3 motors

The latest update of the ErP Directive requires increasingly energy-efficient electric motors, with important implications for their design and protection systems. Eaton's contactors, motor-protective circuit breakers and motor-starter combinations meet the challenges associated with protecting and switching IE3 motors.

Half the number of products for easy warehousing (1 + 1 = ½)

The base unit of the contactors with screw technology from our proven xStart range previously contained either a NC or a NO auxiliary contact. The contactors up to 18.5 kW with Push-in technology are now equipped with two auxiliary contacts (1 NC contact and 1 NO contact) as standard. The footprint, however, remains the same.

While retaining the same small footprint, we've made the contactors more versatile and equipped them for universal use. This reduces the number of different models and simplifies project planning, warehousing and spare parts management.

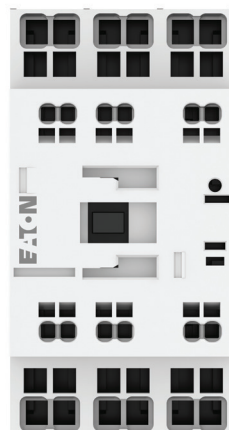



Plug and play

Existing accessories can simply be re-used!

The existing accessories from the xStart range can be easily connected to the new, screw-free devices.

Whether it's auxiliary contacts, suppressor circuits, SmartWire-DT modules or plug-in wiring accessories up to 15.5 A - almost all the available accessories can continue to be used.

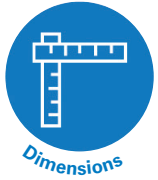

Dimensions

New contactor, new size? - No same dimensions

The new contactors with Push-in technology have the same footprint as the contactors with conventional screw terminals and can therefore easily be installed in existing systems. This also simplifies the planning of new systems, as the dimensions are identical.

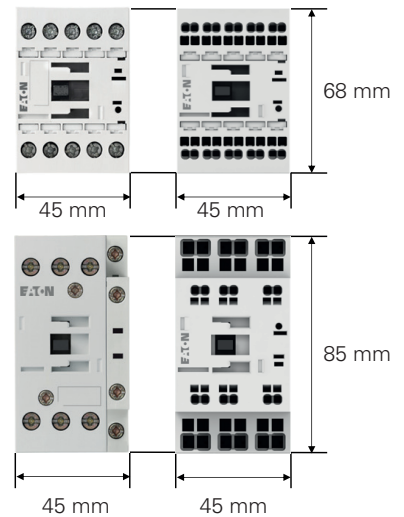

Energy Efficient

Energy savings made easy, thanks to the integrated suppressor circuit

The suppressor circuit is already integrated in every DC operated contactor from Eaton. The contactors can thus be controlled directly from a PLC. Power contactors up to 18.5 kW also feature a coil mechanism for reducing the holding power.

DC / PLC controlled Integrated suppressor circuit

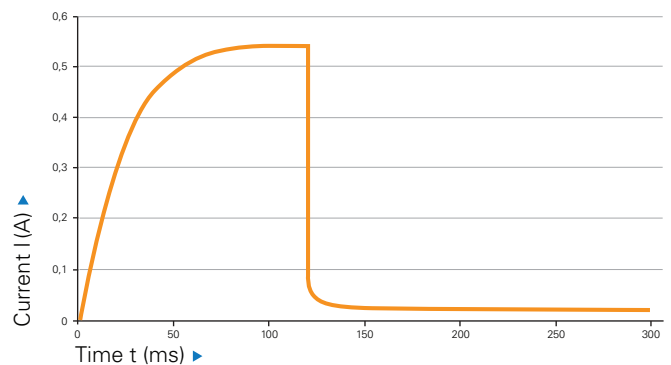
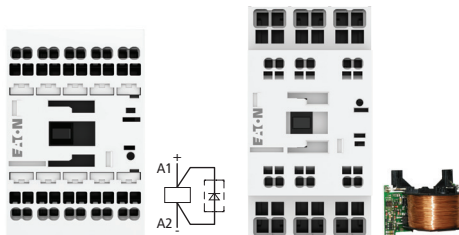

PKZ motor-protective circuit breakers



Eaton's fuseless motor-protective circuit breakers combine short-circuit and overload protection in a single device. The 15 different models of the electromechanical PKZM0 cover the current range from 0.1 to 32 A. The motor-protective circuit breakers are fully compatible with Eaton's DIL contactor series and are therefore ideally suited for use in motor-starter combinations. No matter whether integrated auxiliary switch, release indicator, voltage release or door coupling rotary handles, the accessories can be used universally

and can be combined with all PKZ and PKE motor-protective circuit-breakers with screw connection technology or push-in connection technology.

In order to maintain the familiar power supply of motor-protective circuit breakers using 3-phase busbar links, the Push-in range also includes additional models with screw terminals for supplying power and Push-in terminals for connecting the loads (PKZM0...-SPI).



Designation	PKZM0-PI	PKZM0-SPI32	PKZM0-SPI16
Connection technology supply side load side	Push-in (6 mm ²) Push-in (6 mm ²)	Screw terminal Push-in (6 mm ²)	Screw terminal Push-in (2.5 mm ²)
Rated current range	0.1 ... 32 A	0.1 ... 32 A	0.1 ... 16 A
Power supply by means of 3-phase busbar link	–	Yes	Yes
Suitable for motor-starter combinations	Yes	Yes	–
Special features	100 % tool-free installation	Highly versatile	Extremely small footprint, identical in size to the PKZM0 with screw connection



Plug and play

Existing accessories can simply be re-used!

- Easy integration into existing systems such as the MSFS motor starter feeder system or SASY 60i
- Existing accessories can simply be re-used, no conversion necessary



Dimensions

Suitable for motor-starter combinations

Wiring kits for motor starters up to 32 A

- Mechanical connecting element
- Pre-assembled connecting cables

Suitable for use with

- DOL starters up to 7.5 kW / 15 kW
- Reversing starter combinations up to 15 kW

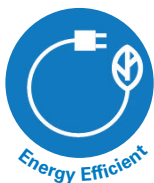

Energy Efficient

Integration into existing control panel designs for global export - Eaton makes it possible!

Our Push-in range boasts a winning combination model that integrates both screw and Push-in connection in a single device.

This means that the new devices can also be easily incorporated into existing control panel designs.

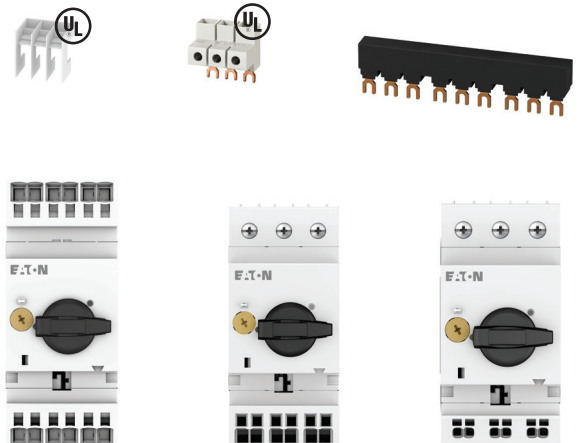

System overview

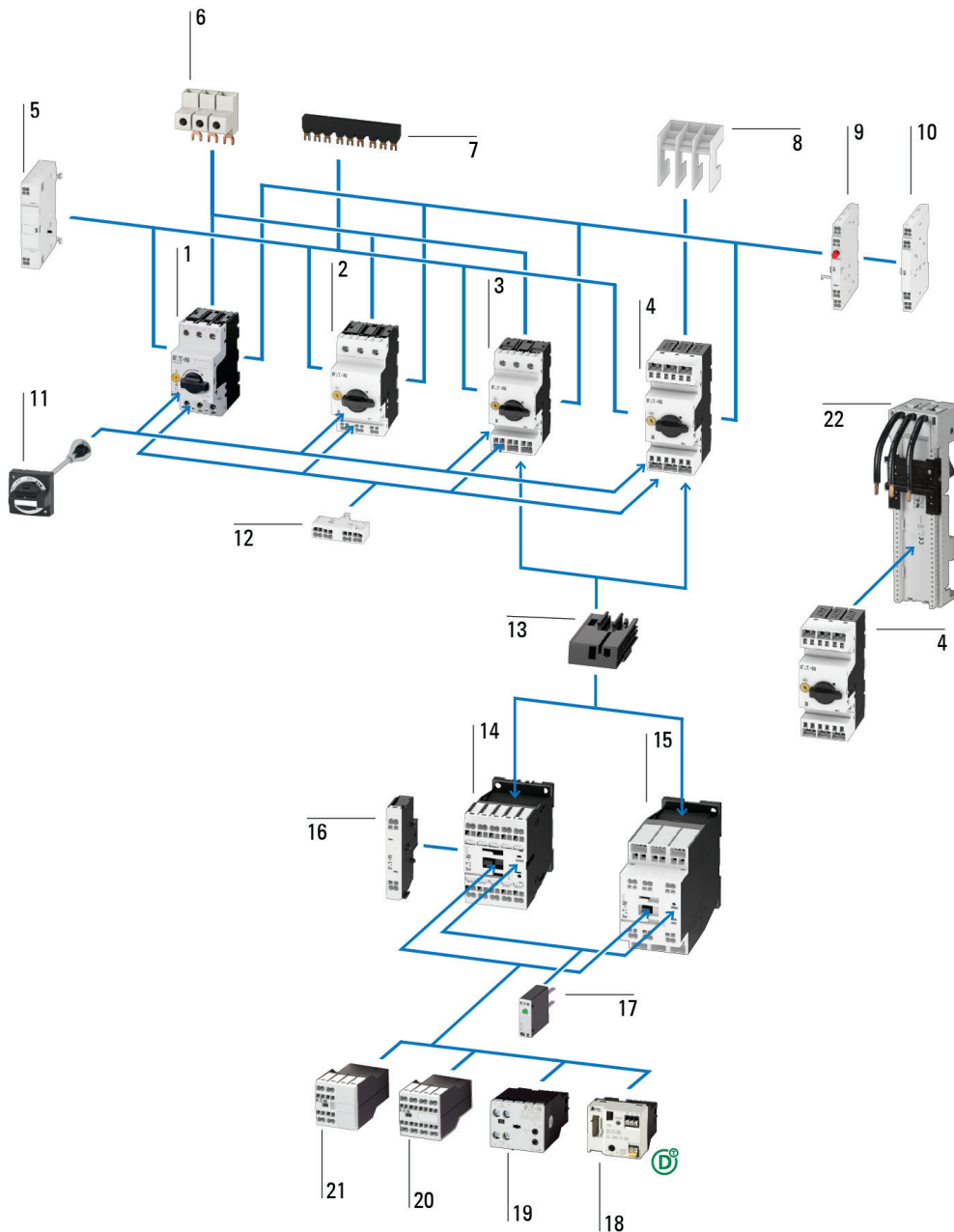





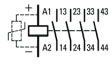
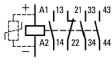
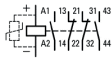



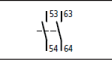
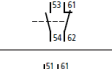
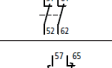

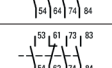
- | | | | |
|----|----------------------------------------------------------------------------|----|------------------------------------------------------------------------|
| 1 | PKZM0 motor-protective circuit breaker up to 32 A – screw terminal | 11 | Door-coupling rotary handle |
| 2 | PKZM0 motor-protective circuit breaker up to 16 A – screw/Push-in terminal | 12 | Front-mounting auxiliary contact – Push-in terminal |
| 3 | PKZM0 motor-protective circuit breaker up to 32 A – screw/Push-in terminal | 13 | Mechanical connection module for motor starters |
| 4 | PKZM0 motor-protective circuit breaker up to 32 A – Push-in terminal | 14 | DILA contactor relay / DILM contactors up to 7.5 kW – Push-in terminal |
| 5 | Undervoltage / shunt release – Push-in terminal | 15 | DILM contactor up to 18.5 kW – Push-in terminal |
| 6 | IEC/UL power supply terminal for three-phase busbar link – screw terminal | 16 | Side-mounting auxiliary contact – Push-in terminal |
| 7 | Three-phase busbar link – screw terminal | 17 | Coil protection circuits |
| 8 | PKZM0...-PI phase isolator / UL Type E and Type F applications | 18 | SmartWire-DT networking module |
| 9 | Trip indicator for overload and short circuit – Push-in terminal | 19 | Electronic timer module – screw terminal |
| 10 | Side-mounting auxiliary contact – Push-in terminal | 20 | Front-mounting auxiliary contact, 4-pole – Push-in terminal |
| | | 21 | Front-mounting auxiliary contact, 2-pole – Push-in terminal |
| | | 22 | Adapter for motor-protective circuit breakers / motor starters |

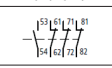
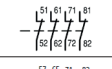
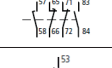
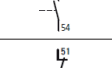
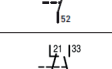
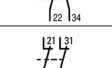
Current	Contacts	Contact sequence	AC operation	AC operation	DC operation
AC15			without suppressor circuit 230 V 50 Hz, 240 V 60 Hz	without suppressor circuit 110 V 50 Hz, 120 V 60 Hz	with suppressor circuit 24 V DC
220 V	NO = normally open NO _e = NO early-make NC = normally closed		Part no. Article no.	Part no. Article no.	Part no. Article no.
240 V	NC _L = NC late-break [⊖]				

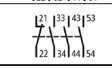
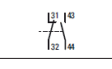
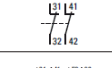
	4	4 NO		DILA-40(230V50HZ,240V60HZ)-PI 199204	DILA-40(110V50HZ,120V60HZ)-PI 199205	DILA-40(24VDC)-PI 199208
	4	3 NO 1 NC		DILA-31(230V50HZ,240V60HZ)-PI 199209	DILA-31(110V50HZ,120V60HZ)-PI 199210	DILA-31(24VDC)-PI 199213
	4	2 NO 2 NC		DILA-22(230V50HZ,240V60HZ)-PI 199214	DILA-22(110V50HZ,120V60HZ)-PI 199215	DILA-22(24VDC)-PI 199218

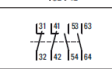
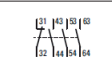
DIL...XHI... auxiliary contact





	4	2 NO		DILA-XHI20-PI 199313	Can be combined with: DILA..(-PI) DILM7..(-PI) up to DILM15..(-PI) DILM8..-PI up to DILM14..-PI DILM17..(-PI) up to DILM38..(-PI) DILMP20..(-PI) up to DILMP45..(-PI) DILL.. DILMF8.. up to DILMF14.. DILMF17.. up to DILMF32..
	4	1 NO 1 NC		DILA-XHI11-PI 199314	
	4	2 NC		DILA-XHI02-PI 199315	
	4	1 NO _E 1 NC _L		DILA-XHIV11-PI 199316	
	4	4 NO		DILA-XHI40-PI 199317	
	4	3 NO 1 NC		DILA-XHI31-PI 199318	
	4	2 NO 2 NC		DILA-XHI22-PI 199319	
	4	1 NO 3 N/C		DILA-XHI13-PI 199320	
	4	4 N/C		DILA-XHI04-PI 199321	
	4	1 NO, 1 NO _E 1 NC, 1 NC _L		DILA-XHIV22-PI 199322	
	4	1 NO		DILA-XHI10-S-PI 199323	Can be combined with: DILA..(-PI) DILM7..(-PI) up to DILM15..(-PI)
	4	1 NC		DILA-XHI01-S-PI 199324	
	4	1 NO 1 NC		DILM12-XHI11-PI 199456	Can be combined with: DILM7-10..(-PI) DILM9-10..(-PI) DILM12-10..(-PI) DILM15-10..(-PI) DILMP20..(-PI)
	4	- 2 NC		DILM12-XHI02-PI 199457	
	4	2 NO 2 NC		DILM12-XHI22-PI 199458	
	4	3 NO 1 NC		DILM12-XHI31-PI 199459	
	4	1 NO 1 NC		DILM32-XHI11-PI 199309	Can be combined with: DILM7-10..(-PI) DILM9-10..(-PI) DILM12-10..(-PI) DILM15-10..(-PI) DILMP20..(-PI) DILM17-11..(-PI) DILM25-11..(-PI) DILM32-11..(-PI) DILM38-11..(-PI) DILMP32..(-PI) DILMP45..(-PI)
	4	- 2 NC		DILM32-XHI02-PI 199310	
	4	2 NO 2 NC		DILM32-XHI22-PI 199311	
	4	3 NO 1 NC		DILM32-XHI31-PI 199312	

Notes: AC-operated basic devices are also available for 24 V 50/60 Hz, 230 V 50/60 Hz, 42 V 50 Hz and 48 V 60 Hz



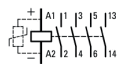
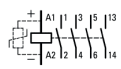
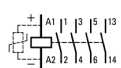
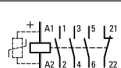

Contactors from 3 kW to 18.5 kW

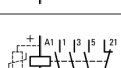
Current	Contacts	Contact sequence	AC operation without suppressor circuit 230 V 50 Hz, 240 V 60 Hz	AC operation without suppressor circuit 110 V 50 Hz, 120 V 60 Hz	DC operation with suppressor circuit 24 V DC
AC3 380 V 400 V A kW	NO = normally open NC = normally closed	Contact sequence	Part no. Article no.	Part no. Article no.	Part no. Article no.

Contactors from 3 kW to 7.5 kW - frame size 1

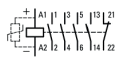
	7	3	1 NO -		DILM7-10(230V50HZ,240V60HZ)-PI 199219	DILM7-10(110V50HZ,120V60HZ)-PI 199220	DILM7-10(24VDC)-PI 199223
	9	4	1 NO -		DILM9-10(230V50HZ,240V60HZ)-PI 199229	DILM9-10(110V50HZ,120V60HZ)-PI 199230	DILM9-10(24VDC)-PI 199233
	12	5.5	1 NO -		DILM12-10(230V50HZ,240V60HZ)-PI 199239	DILM12-10(110V50HZ,120V60HZ)-PI 199240	DILM12-10(24VDC)-PI 199243
	15.5	7.5	1 NO -		DILM15-10(230V50HZ,240V60HZ)-PI 199249	DILM15-10(110V50HZ,120V60HZ)-PI 199250	DILM15-10(24VDC)-PI 199253
	7	3	- 1 NC		DILM7-01(230V50HZ,240V60HZ)-PI 199224	DILM7-01(110V50HZ,120V60HZ)-PI 199225	DILM7-01(24VDC)-PI 199228
	9	4	- 1 NC		DILM9-01(230V50HZ,240V60HZ)-PI 199234	DILM9-01(110V50HZ,120V60HZ)-PI 199235	DILM9-01(24VDC)-PI 199238
	12	5.5	- 1 NC		DILM12-01(230V50HZ,240V60HZ)-PI 199244	DILM12-01(110V50HZ,120V60HZ)-PI 199245	DILM12-01(24VDC)-PI 199248
	15.5	7.5	- 1 NC		DILM15-01(230V50HZ,240V60HZ)-PI 199254	DILM15-01(110V50HZ,120V60HZ)-PI 199255	DILM15-01(24VDC)-PI 199258

Contactors from 3 kW to 18.5 kW - frame size 2

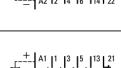
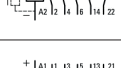
	8	3	1 NO 1 NC		DILM8-11 (230V50HZ,240V60HZ)-PI 199264	DILM8-11(110V50HZ,120V60HZ)-PI 199265	DILM8-11(RDC24)-PI 199268
	11	4	1 NO 1 NC		DILM11-11(230V50HZ,240V60HZ)-PI 199269	DILM11-11(110V50HZ,120V60HZ)-PI 199270	DILM11-11(RDC24)-PI 199273
	14	5.5	1 NO 1 NC		DILM14-11(230V50HZ,240V60HZ)-PI 199274	DILM14-11(110V50HZ,120V60HZ)-PI 199275	DILM14-11(RDC24)-PI 199278
	17	7.5	1 NO 1 NC		DILM17-11(230V50HZ,240V60HZ)-PI 199279	DILM17-11(110V50HZ,120V60HZ)-PI 199280	DILM17-11(RDC24)-PI 199283
	25	11	1 NO 1 NC		DILM25-11(230V50HZ,240V60HZ)-PI 199284	DILM25-11(110V50HZ,120V60HZ)-PI 199285	DILM25-11(RDC24)-PI 199288
	32	15	1 NO 1 NC		DILM32-11(230V50HZ,240V60HZ)-PI 199289	DILM32-11(110V50HZ,120V60HZ)-PI 199290	DILM32-11(RDC24)-PI 199293
	38	18.5	1 NO 1 NC		DILM38-11(230V50HZ,240V60HZ)-PI 199294	DILM38-11(110V50HZ,120V60HZ)-PI 199295	DILM38-11(RDC24)-PI 199298

Notes: AC-operated basic devices are also available for 24 V 50/60 Hz, 230 V 50/60 Hz, 42 V 50 Hz and 48 V 60 Hz.

DILMP contactors up to 45 A, 4-pole

Current			AC operation with suppressor circuit 230 V 50 Hz, 240 V 60 Hz	AC operation with suppressor circuit 110 V 50 Hz, 120 V 60 Hz	DC operation with suppressor circuit 24 V DC
AC1	A at 40°C	A at 60°C	Part no. Article no.	Part no. Article no.	Part no. Article no.
		Contact sequence			

DILMP 22 A, 4-pole - frame size 1

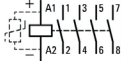
	22	20		DILMP20(230V50HZ,240V60HZ)-PI 199259	DILMP20(110V50HZ,120V60HZ)-PI 199260	DILMP20(24VDC)-PI 199263
-----------------------------------------------------------------------------------	----	----	-----------------------------------------------------------------------------------	------------------------------------------------	------------------------------------------------	------------------------------------

DILMP up to 45 A, 4-pole - frame size 2

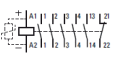
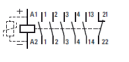
	32	28		DILMP32-11(230V50HZ,240V60HZ)-PI 199299	DILMP32-11(110V50HZ,120V60HZ)-PI 199300	DILMP32-11(RDC24)-PI 199303
	45	39		DILMP45-11(230V50HZ,240V60HZ)-PI 199304	DILMP45-11(110V50HZ,120V60HZ)-PI 199305	DILMP45-11(RDC24)-PI 199308

Notes: AC-operated DILMP basic devices are also available for 24 V 50/60 Hz, 42 V 50 Hz and 48 V 60 Hz.

Contactor accessories

	For use with	Part no. Article no.	Std. pack
--	--------------	-------------------------	-----------

Star-delta wiring kit, includes star point bridge

Main power wiring for star-delta combination

	DILM7/9/12/15-10..(-PI) mains contactor	DILM12-XSL 283130	1 unit
	DILM7/9/12/15-01..(-PI) delta contactor		
	DILM7/9/12/15-01..(-PI) star contactor		
	DILM17/25/32-11..-PI mains contactor	DILM32-XSL-PI 199461	
	DILM17/25/32-11..-PI delta contactor		
	DILM17/25/32-11..-PI star contactor		

Reversing wiring kits

Main power wiring for reversing combination

	DILM7-01..(-PI)	DILM12-XRL 283108	1 unit
	DILM9-01..(-PI)		
	DILM12-01..(-PI)		
	DILM17-11..-PI	DILM32-XRL-PI 199460	
	DILM25-11..-PI		
	DILM32-11..-PI		

Mechanical interlock

	DILA..(-PI)	DILM12-XMV 281196	1 unit
	DILM7..(-PI) - DILM15..(-PI)		
	DILMP20..(-PI)		
	DILM17-11..PPI		
	DILM25-11..PPI		
	DILM32..(-PI)		



Connector

To mechanically link contactor relays in combinations with a contactor distance of 0 mm

	DILA..(-PI)	DILM32-XVB 281227	50 units
	DILM7..(-PI) - DILM38..(-PI)		

SmartWire-DT contactor modules

For connecting contactors to SmartWire-DT One module is needed for each contactor.

	Notifications: switch state of the contactor, status of the digital inputs 1 and 2, contactor control commands	DILA..(-PI)	DIL-SWD-32-001 118560	5 units
		DILM7..(-PI) - DILM38..(-PI)		
		DILMP..(-PI)		
		MSC-D(R)..(24VDC)(-PI)		
	Notifications: switch state of the contactor, status of the digital inputs 1 and 2, 1-0-A switch contactor control commands	DIL-SWD-32-002 118561		

PKZM0 motor-protective circuit breakers

Max. load rating	Max. rated uninterrupted current	Setting range	Push-in terminals / Push-in terminals*	Screw terminal / Push-in terminal* (6 mm ²)	Screw terminal / Push-in terminal* (2.5 mm ²)
AC-3 [kW]	I_u	Overload release			
380 V/400 V/415 V	A	A	Part no. Article no.	Part no. Article no.	Part no. Article no.

Type of coordination: 1 and 2

			PKZM0-0,16-PI 199148	PKZM0-0,16-SPI32 199189	PKZM0-0,16-SPI16 199177
-	0.16	0.1 - 0.16			
0.06	0.25	0.16 - 0.25	PKZM0-0,25-PI 199149	PKZM0-0,25-SPI32 199190	PKZM0-0,25-SPI16 199178
0.09	0.4	0.25 - 0.4	PKZM0-0,4-PI 199150	PKZM0-0,4-SPI32 199191	PKZM0-0,4-SPI16 199179
0.12	0.63	0.4 - 0.63	PKZM0-0,63-PI 199151	PKZM0-0,63-SPI32 199192	PKZM0-0,63-SPI16 199180
0.25	1	0.63 - 1	PKZM0-1-PI 199152	PKZM0-1-SPI32 199193	PKZM0-1-SPI16 199181
0.55	1.6	1 - 1.6	PKZM0-1,6-PI 199153	PKZM0-1,6-SPI32 199194	PKZM0-1,6-SPI16 199182
0.75	2.5	1.6 - 2.5	PKZM0-2,5-PI 199154	PKZM0-2,5-SPI32 199195	PKZM0-2,5-SPI16 199183
1.5	4	2.5 - 4	PKZM0-4-PI 199155	PKZM0-4-SPI32 199196	PKZM0-4-SPI16 199184
2.2	6.3	4 - 6.3	PKZM0-6,3-PI 199156	PKZM0-6,3-SPI32 199197	PKZM0-6,3-SPI16 199185
4	10	6.3 - 10	PKZM0-10-PI 199157	PKZM0-10-SPI32 199198	PKZM0-10-SPI16 199186
5.5	12	8 - 12	PKZM0-12-PI 199158	PKZM0-12-SPI32 199199	PKZM0-12-SPI16 199187
7.5	16	12 - 16	PKZM0-16-PI 199159	PKZM0-16-SPI32 199200	PKZM0-16-SPI16 199188
9	20	16 - 20	PKZM0-20-PI 199160	PKZM0-20-SPI32 199201	
12.5	25	20 - 25	PKZM0-25-PI 199161	PKZM0-25-SPI32 199202	
15	32	25 - 32	PKZM0-32-PI 199162	PKZM0-32-SPI32 199203	











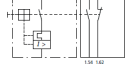
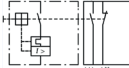
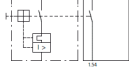

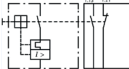
Notes: * The PKZM0...-PI and PKZM0-...-SPI32 motor-protective circuit breakers can be used to assemble motor starter combinations. The PKZM0-...-SPI16 and the SPI32 can be used for power supply via a BK25/3-PKZ0(-E) supply terminal and a three-phase busbar link.

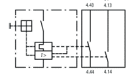
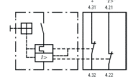
Transformer-protective circuit breaker (short-circuit release [I_{rm}]= 20 x I_u)

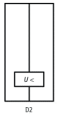

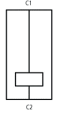
0.16	0.1 - 0.16	PKZM0-0,16-T-PI 199163
0.25	0.16 - 0.25	PKZM0-0,25-T-PI 199164
0.4	0.25 - 0.4	PKZM0-0,4-T-PI 199165
0.63	0.4 - 0.63	PKZM0-0,63-T-PI 199166
1	0.63 - 1	PKZM0-1-T-PI 199167
1.6	1 - 1.6	PKZM0-1,6-T-PI 199168
2.5	1.6 - 2.5	PKZM0-2,5-T-PI 199169
4	2.5 - 4	PKZM0-4-T-PI 199170
6.3	4 - 6.3	PKZM0-6,3-T-PI 199171
10	6.3 - 10	PKZM0-10-T-PI 199172
12	8 - 12	PKZM0-12-T-PI 199173
16	12 - 16	PKZM0-16-T-PI 199174
20	16 - 20	PKZM0-20-T-PI 199175
25	20 - 25	PKZM0-25-T-PI 199176

Motor-protective circuit breaker accessories

Contact configuration		Contact diagram	Part no.	For use with	Std. pack
NO = normally open	NC = normally closed		Article no.		
Front-mounting auxiliary contacts for motor-protective circuit breakers					
	1 NO 1 NC		NHI-E2-11-PKZ0-PI EP-401015	PKZM0..(-PI)(-SPI32) PKZM0-...T(-PI)	5 units
	1 NO 1 NC		NHI-B2-11-PKZ0-PI EP-401016		
	1 NO -		NHI-E2-10-PKZ0-PI EP-401017		
Lateral auxiliary contacts for motor-protective circuit breakers					
	1 NO 1 NC		NHI11-PKZ0-PI 199328	PKZM0..(-PI)(-SPI32) PKZM0-...T(-PI)	5 units
Trip-indicating auxiliary contacts for motor-protective circuit breakers					
	2 x 1 NO -		AGM2-10-PKZ0-PI 199329	PKZM0..(-PI)(-SPI32) PKZM0-...T(-PI)	2 units
	- 2 x 1 NC		AGM2-01-PKZ0-PI 199330		
Undervoltage releases					
			U-PKZ0(230V50HZ)-PI 199334	PKZM0..(-PI)(-SPI32) PKZM0-...T(-PI)	2 units
Shunt releases					
			A-PKZ0(230V50HZ)-PI 199339	PKZM0..(-PI)(-SPI32) PKZM0-...T(-PI)	2 units
			A-PKZ0(24VDC)-PI 199336		
Type E phase isolators					
			LSA-PKZ0-E-PI 199341	PKZM0..-PI	5 units
Wiring kits for motor-starter combinations					
			PKZM0-XDM12-PI 199463	DOL starters up to 7.5 kW	1 unit
			PKZM0-XRM12-PI 199464	Reversing starters up to 7.5 kW	
			PKZM0-XDM32-PI 199465	DOL starters up to 15 kW	
			PKZM0-XRM32-PI 199466	Reversing starters up to 15 kW	
Mechanical connector					
			PKZM0-XDM32M-PI 199462	PKZM0..-PI(-SPI32) + DILM7..-PI - DILM38..-PI	1 unit

Motor-protective circuit breaker accessories





Residual current circuit breakers	Length	Unit width	Part no. Article no.	Notes	Std. pack
Quantity	mm	mm			

Supply terminals





	-	-	-	BK25/3-PKZ0 032720	For use with: PKZM0-.., PKZM0..-SPI16, PKZM0..-SPI32	5 units
	-	-	-	BK25/3-PKZ0-E 262518	touch-safe, for three-phase busbar links $U_n = 690\text{ V}$, $I_n = 63\text{ A}$ / $I_n = 60\text{ A}$ (BK25/3-PKZ0-E) for conductor cross-sections: 2.5 - 25 mm ² stranded 2.5 - 16 mm ² flexible with ferrule	

B3...-PKZ0 three-phase busbar links



for PKZM0-..(-SPI16, -SPI32) without lateral auxiliary contacts or voltage releases

	2	90	45	B3.0/2-PKZ0 063961	for parallel power supply of several motor-protective circuit breakers	10 units
	3	135	45	B3.0/3-PKZ0 232289	touch-safe, short-circuit proof, $U_e=690\text{ V}$, $I_n=63\text{ A}$	
	4	180	45	B3.0/4-PKZ0 063960		
	5	225	45	B3.0/5-PKZ0 232290		

for PKZM0-.. (-SPI16, -SPI32) with one lateral auxiliary switch or one trip indicator mounted on the right

	2	99	45 + 9	B3.1/2-PKZ0 044945	for parallel power supply of several motor-protective circuit breakers	10 units
	3	153	45 + 9	B3.1/3-PKZ0 044946	touch-safe, short-circuit proof, $U_e=690\text{ V}$, $I_n=63\text{ A}$	
	4	207	45 + 9	B3.1/4-PKZ0 044947		
	5	261	45 + 9	B3.1/5-PKZ0 044948		

for PKZM0-.. (-SPI16, -SPI32) with one lateral auxiliary switch or
one trip indicator mounted on the right, or with one voltage release mounted on the left

	2	108	45 + 18	B3.2/2-PKZ0 063963	for parallel power supply of several motor-protective circuit breakers	10 units
	4	234	45 + 18	B3.2/4-PKZ0 063959	touch-safe, short-circuit proof, $U_e=690\text{ V}$, $I_n=63\text{ A}$	

Shroud for unused terminals





	touch-safe to cover unused terminals on the B3...-PKZ0 three-phase busbar link					
				H-B3-PKZ0 032721		20 units

Power supply adapter





Rated operational voltage	Cable dimensions	Adapter width	DIN rail	Part no.		
Ue [V]	mm ² /AWG	mm	Quantity	Article no.	For use with	Std. pack

Power supply adapter for SASY60i busbar system

For motor starters with a rated operational current of max. 32 A

	690	4 / 12	45	1	BBA0-25-PI 199467	DOL starter PKZM0..-PI + DILM7 (9) (12) (15) -PI	4 units
	690	4 / 12	90	1	BBA0R-25-PI 199468	Reversing starter PKZM0..-PI + 2x DILM7 (9) (12) (15) -PI	2 units
	690	6 / 10	45	1	BBA0K-32-PI 199635	Motor-protective circuit-breaker PKZM0-PI	1 unit
	690	6 / 10	45	2	BBA0-32-PI 199469	DOL starter PKZM0..-PI + DILM8 (11) (14) (17) (25) (32)..-PI	4 units
	690	6 / 10	90	3	BBA0R-32-PI 199470	Reversing starter PKZM0..-PI + 2x DILM8 (11) (14) (17) (25) (32)-PI	2 units

Power supply adapter for the motor starter feeder system

	690	6 / 10	45	1	MSFA0-32 191095	PKZM0, PKZM0..-SPI16, PKZM0..-SPI32	4 units
	690	6 / 10	45	1	MSFA0-32-PI 199471	PKZM0..-PI	
	690	4 / 12	45	1	MSFAD-25-PI 199472	DOL starter PKZM0..-PI + DILM7(9)(12)(15)-PI	
	690	4 / 12	90	1	MSFAR-25-PI 199473	Reversing starter PKZM0..-PI + 2x DILM8(11)(14)(17)(25)(32)-PI	2 units
	690	6 / 10	45	1	MSFAD-32-PI 191098	DOL starter PKZM0..-PI + DILM8 (11) (14) (17) (25) (32)-PI	4 units

Max. load rating	Rated uninterrupted current	Settings range	Motor starter	Motor starter
AC-3 [kW]	I_u	Overload release	230 V 50 Hz, 240 V 60 Hz	24 V DC
380 V/400 V/415 V	A	I_r	Part no.	Part no.
		A	Article no.	Article no.

DOL starter – MSC-D-PI complete devices



0.06	0.21	0.16 - 0.25	MSC-D-0,25-M7(230V50HZ)-PI 199561	MSC-D-0,25-M7(24VDC)-PI 199572
0.09	0.31	0.25 - 0.4	MSC-D-0,4-M7(230V50HZ)-PI 199562	MSC-D-0,4-M7(24VDC)-PI 199573
0.12	0.41 0.6	0.4 - 0.63	MSC-D-0,63-M7(230V50HZ)-PI 199563	MSC-D-0,63-M7(24VDC)-PI 199574
0.25	0.8	0.63 - 1	MSC-D-1-M7(230V50HZ)-PI 199564	MSC-D-1-M7(24VDC)-PI 199575
0.55	1.1 1.5	1 - 1.6	MSC-D-1,6-M7(230V50HZ)-PI 199565	MSC-D-1,6-M7(24VDC)-PI 199576
0.75	1.9	1.6 - 2.5	MSC-D-2,4-M7(230V50HZ)-PI 199566	MSC-D-2,4-M7(24VDC)-PI 199577
1.5	2.6 3.6	2.5 - 4	MSC-D-4-M7(230V50HZ)-PI 199567	MSC-D-4-M7(24VDC)-PI 199578
2.2	5	4 - 6.3	MSC-D-6,3-M7(230V50HZ)-PI 199568	MSC-D-6,3-M7(24VDC)-PI 199579
3 4	6.6 8.5	6.3 - 10	MSC-D-10-M9(230V50HZ)-PI 199569	MSC-D-10-M9(24VDC)-PI 199580
5.5	11.3	8 - 12	MSC-D-12-M12(230V50HZ)-PI 199570	MSC-D-12-M12(24VDC)-PI 199581
7.5	15.2	10 - 16	MSC-D-16-M15(230V50HZ)-PI 199571	MSC-D-16-M15(24VDC)-PI 199582
3 4	11.3	6.3 - 10	MSC-D-10-M11(230V50HZ)-PI 199605	MSC-D-10-M11(24VDC)-PI 199610
5.5	15.2	8 - 12	MSC-D-12M14(230V50HZ)-PI 199606	MSC-D-12-M14(24VDC)-PI 199611
7.5	15.2	10 - 16	MSC-D-16-M17(230V50HZ)-PI 199607	MSC-D-16-M17(24VDC)-PI 199612
11	21.7	20 - 25	MSC-D-25-M25(230V50HZ)-PI 199608	MSC-D-25-M25(24VDC)-PI 199613
15	29.3	25 - 32	MSC-D-32-M32(230V50HZ)-PI 199609	MSC-D-32-M32(24VDC)-PI 199614



Notes: The DOL starters (complete devices) consist of a PKZM0...-PI motor-protective circuit breaker and a DILM...-PI contactor. Further information: for the technical data of the PKZM0...-PI; see page 24, for the technical data of the DILM...-PI, see page 22

Reversing starters – MSC-R-PI complete devices



0.06	0.21	0.16 - 0.25	MSC-R-0,25-M7(230V50HZ)-PI 199583	MSC-R-0,25-M7(24VDC)-PI 199594
0.09	0.31	0.25 - 0.4	MSC-R-0,4-M7(230V50HZ)-PI 199584	MSC-R-0,4-M7(24VDC)-PI 199595
0.12 0.18	0.41 0.6	0.4 - 0.63	MSC-R-0,63-M7(230V50HZ)-PI 199585	MSC-R-0,63-M7(24VDC)-PI 199596
0.25	0.8	0.63 - 1	MSC-R-1-M7(230V50HZ)-PI 199586	MSC-R-1-M7(24VDC)-PI 199597
0.37 0.55	1.1 1.5	1 - 1.6	MSC-R-1,6-M7(230V50HZ)-PI 199587	MSC-R-1,6-M7(24VDC)-PI 199598
0.75	1.9	1.6 - 2.5	MSC-R-2,4-M7(230V50HZ)-PI 199588	MSC-R-2,4-M7(24VDC)-PI 199599
1.1 1.5	2.6 3.6	2.5 - 4	MSC-R-4-M7(230V50HZ)-PI 199589	MSC-R-4-M7(24VDC)-PI 199600
2.2	5	4 - 6.3	MSC-R-6,3-M7(230V50HZ)-PI 199590	MSC-R-6,3-M7(24VDC)-PI 199601
4	8.5	6.3 - 10	MSC-R-10-M9(230V50HZ)-PI 199591	MSC-R-10-M9(24VDC)-PI 199602
5.5	11.3	8 - 12	MSC-R-12-M12(230V50HZ)-PI 199592	MSC-R-12-M12(24VDC)-PI 199603
5.5	11.3	10 - 16	MSC-R-16-M15(230V50HZ)-PI 199593	MSC-R-16-M15(24VDC)-PI 199604

Notes: The DOL starters (complete devices) consist of a PKZM0...-PI motor-protective circuit breaker and a DILM...-PI contactor. Further information: for the technical data of the PKZM0...-PI, see page 24; for the technical data of the DILM...-PI, see page 22

Breaking capacity PKZM0-...-(S)PI(16/32), PKZM0-...-T-PI with type 1 and 2 coordination

Rated uninterrupted current I_u

Rated conditional short-circuit current I_q IEC/EN 60947-4-1

Rated ultimate short-circuit breaking capacity I_{cu} IEC/EN 60947-2

Rated operational short-circuit breaking capacity I_{cs} IEC/EN 60947-2

I_u A	230 V				400 V				440 V				500 V				690 V			
	I_a kA	I_{cu} kA	I_{cs} kA	A*)	I_a kA	I_{cu} kA	I_{cs} kA	A*)	I_a kA	I_{cu} kA	I_{cs} kA	A*)	I_a kA	I_{cu} kA	I_{cs} kA	A*)	I_a kA	I_{cu} kA	I_{cs} kA	A*)
0.16 - 1	150	150	150	N	150	150	150	N	150	150	150	N	150	150	150	N	150	150	150	N
1.6	150	150	150	N	150	150	150	N	150	150	150	N	150	150	150	N	150	150	150	N
2.5	150	150	150	N	150	150	150	N	150	150	150	N	150	150	150	N	5	5	5	50
4	150	150	150	N	150	150	150	N	150	150	150	N	150	150	150	N	3	3	3	50
6.3	150	150	150	N	150	150	150	N	150	150	150	N	42	42	42	50	3	3	2	50
10	150	150	150	N	150	150	150	N	50	50	50	50	42	42	11	50	3	3	2	50
12	50	50	38	50	50	50	38	50	50	15	12	50	15	15	4	50	3	3	2	50
16	50	50	38	50	50	50	38	50	50	15	15	50	15	15	4	50	3	3	2	50
20	50	50	38	50	50	50	38	50	50	10	3	50	10	3	3	50	3	3	1	50
25	50	50	38	50	50	50	38	50	50	10	3	50	10	3	3	50	3	3	1	50
32	50	40	10	50	50	40	10	50	50	10	3	50	10	3	3	50	3	3	1	50

*) Required back-up fuse, if the short-circuit current exceeds the conditional rated short-circuit current of the devices (I_{cs} is greater than I_a)

Motor-starter combinations

Motor Power					Setting range	Short circuit current ratings			Supply terminal	Motor-protective circuit breaker	Contactor
					Overload release	Short-circuit release	240 V	480 V/ 277 V ²⁾	600 V/ 347 V ²⁾		
					instantaneous						
200 V	230 V	460 V	575 V								
208 V	240 V	480 V	600 V								
HP	HP	HP	HP	I _r [A]	I _{rm} [A]	kA	kA	kA	Part no.	Part no.	Part no.
PKZM, DILM, BK Type F starter combinations											
				0.1 - 0.16	5	65	65	18		PKZM0-0,16-(S)PI(16/32)	DILM7-...-PI / DILM8-...-PI
				0.16 - 0.25	9	65	65	18		PKZM0-0,25-(S)PI(16/32)	DILM7-...-PI / DILM8-...-PI
				0.25 - 0.4	6.2	65	65	18		PKZM0-0,4-(S)PI(16/32)	DILM7-...-PI / DILM8-...-PI
				0.4 - 0.63	9	65	65	18	LSA-PKZ0-E-PI (for PKZ...-PI)	PKZM0-0,63-(S)PI(16/32)	DILM7-...-PI / DILM8-...-PI
	1/2	1/2		0.63 - 1	15.5	65	65	18		PKZM0-1-(S)PI(16/32)	DILM7-...-PI / DILM8-...-PI
	3/4	1		1 - 1.6	24.8	65	65	18		PKZM0-1,6-(S)PI(16/32)	DILM7-...-PI / DILM8-...-PI
1/2	1/2	1	1 1/2	1.6 - 2.5	38.8	65	65	18		PKZM0-2,5-(S)PI(16/32)	DILM7-...-PI / DILM8-...-PI
1 3/4	1 3/4	2	3	2.5 - 4	62	65	65	18		PKZM0-4-(S)PI(16/32)	DILM7-...-PI / DILM8-...-PI
1 1/2	1 1/2	3	5	4 - 6.3	97.7	65	65	18	BK25/3-PKZ0-E (for PKZ...-SPI...)	PKZM0-6,3-(S)PI(16/32)	DILM7-...-PI / DILM8-...-PI
3	3	7 1/2	10	6.3 - 11	155	65	65	18		PKZM0-10-(S)PI(16/32)	DILM9-...-PI / DILM11-...-PI
3	3	7 1/2	10	9 - 12	186	65	65	-		PKZM0-12-(S)PI(16/32)	DILM12-...-PI / DILM14-...-PI
3	5	10	-	10 - 16	248	65	65	-		PKZM0-16-(S)PI(16/32)	DILM17-...-PI
5	-	-	-	16 - 20	310	18	18	-		PKZM0-20-PI	DILM25-...-PI
-	7 1/2	15	-	20 - 25	388	18	18	-		PKZM0-25-PI	DILM25-...-PI

Notes:

- IEC devices for world markets \triangleq UL/CSA
- The setting value I_r of the current scale (depending on the load factor)
- SF (service factor) = 1.15 \rightarrow I_r = 1 x I_n mot
- SF (service factor) = 1.0 \rightarrow I_r = 0.9 x I_n mot
- Type F starter combinations do not need an upstream protective device.
- For use in Canada, the switch must be equipped with an AK-PKZ0.
- ¹⁾ The motor output must be calculated on the basis of the rated current. Specified values according to NEC Table 430-150.
- ²⁾ Suitable for star-point grounded networks

Protection of PVC-insulated cables against thermal overload in the event of a short circuit

The table indicates the minimum conductor cross-sections that are protected by the motor-protective circuit breakers up to their conditional rated short-circuit current I_q

Min. protected cross-section	Device Part no.
380 - 415 V 50 Hz	
CU mm ²	
4	PKZM0-0,16-(S)PI(16/32)
2.5	...
1.5	PKZM0-6,3-(S)PI(16/32)
1	PKZM0-10-(S)PI(16/32)
0.75	PKZM0-12-(S)PI(16/32)
	PKZM0-16-(S)PI(16/32)
	PKZM0-20-PI
	PKZM0-25-PI
	PKZM0-32-PI
	PKZM0-32-PI

Technical data - PKZM0-...-PI motor-protective circuit breakers

		PKZM0-...-PI	PKZM0-...-T-PI	PKZM0-...-SPI32	PKZM0-...-SPI16	
Max. motor rating						
AC-3						
220 V 230 V 240 V	P	kW	0.06 - 7.5	-	0.06 - 7.5	0.06 - 4
380 V 400 V 415 V	P	kW	0.06 - 15	-	0.06 - 15	0.06 - 7.5
440 V	P	kW	0.06 - 15	-	0.06 - 15	0.06 - 9
500 V	P	kW	0.06 - 22	-	0.06 - 22	0.06 - 9
660 V 690 V	P	kW	0.06 - 30	-	0.06 - 30	0.06 - 12.5
Settings range						
Overload release	I_r	A	0.1 - 32	0.1 - 25	0.1 - 32	0.1 - 16
Short-circuit release	I_{rm}	A	2.4 - 496	2.4 - 437	2.4 - 496	2.4 - 248
General information						
Standards	IEC/EN 60947, VDE 0660, UL, CSA					
Connection cross-sections of push-in terminals						
solid	mm ²	1 x (1 - 6), 2 x (1 - 6)			1 x (0.5 - 2.5), 2 x (0.5 - 2.5)	
flexible with ultrasonic welded busbar end	mm ²	1 x (1 - 10), 2 x (1 - 6)			1 x (0.5 - 2.5), 2 x (0.5 - 2.5)	
flexible without ferrule	mm ²	1 x (1 - 6), 2 x (1 - 6)			1 x (0.5 - 2.5), 2 x (0.5 - 2.5)	
flexible with uninsulated ferrule	mm ²	1 x (1 - 6), 2 x (1 - 6)			1 x (0.5 - 2.5), 2 x (0.5 - 2.5)	
flexible with ferrule to DIN 46228	mm ²	1 x (1 - 6), 2 x (1 - 4)			1 x (0.5 - 1.5), 2 x (0.5 - 1.5)	
solid, stranded or flexible	AWG	18 - 8			20 - 14	
Stripping length	mm	12			10	
Tool for opening the terminal	mm	3.0 x 0.5 slotted screwdriver				
Connection cross-sections of screw terminals						
solid	mm ²	-	1 x (1 - 6), 2 x (1 - 6)		1 x (1 - 6), 2 x (1 - 6)	
flexible with ferrule to DIN 46228	mm ²	-	1 x (1 - 6), 2 x (1 - 6)		1 x (1 - 6), 2 x (1 - 6)	
solid, stranded or flexible	AWG	-	18 - 10		18 - 10	
Stripping length	mm	-	10		10	
Main circuits						
Rated impulse-withstand voltage	U_{imp}	V AC	6000			
Rated operational voltage	U_{imp}	V AC	690			
Current heat loss (3-pole operating temperature)	W	6				
Release						
Temperature compensation						
to IEC/EN 60947, VDE 0660	°C	-5 ... +40				
Operating range	°C	-25 ... +55				
Residual error of the temperature compensation for T > 40 °C	≤ 0.25 %/K					
Setting range of the overload release	x I_u	0.6-1				
Short-circuit release	Basic device, fixed setting: 15.5 x I_u					
Tolerance of the short-circuit release	± 20%					
Phase failure sensitivity	IEC/EN 60947-4-1, VDE 0660 Part 102					

Technical data - DILM(P)-...-PI contactor

Basic devices up to 18.5 kW

DILM7-...-PI DILM9-...-PI DILM12-...-PI DILM15-...-PI DILM20-...-PI

General information

Standards	IEC/EN 60947, VDE 0660, UL, CSA				
-----------	---------------------------------	--	--	--	--

Mechanical service life

AC-operated	Number of operations	x 10 ⁶	10	10	10	10	10
DC-operated	Number of operations	x 10 ⁶	10	10	10	10	10

Connection cross-section of main circuits

solid	mm ²	1 x (0.5 - 2.5), 2 x (0.5 - 2.5)				
flexible with ultrasonic welded busbar end	mm ²	1 x (0.5 - 2.5), 2 x (0.5 - 2.5)				
flexible without ferrule	mm ²	1 x (0.5 - 2.5), 2 x (0.5 - 2.5)				
flexible with uninsulated ferrule	mm ²	1 x (0.5 - 2.5), 2 x (0.5 - 2.5)				
flexible with ferrule to DIN 46228	mm ²	1 x (0.5 - 2.5), 2 x (0.5 - 1.5)				
solid, stranded or flexible	AWG	20 - 14				
Stripping length	mm	10				
Tool for opening the terminal	mm	3.0 x 0.5 slotted screwdriver				

Connection cross-section of auxiliary circuits

solid	mm ²	1 x (0.5 - 2.5), 2 x (0.5 - 2.5)				
flexible with ultrasonic welded busbar end	mm ²	1 x (0.5 - 2.5), 2 x (0.5 - 2.5)				
flexible without ferrule	mm ²	1 x (0.5 - 2.5), 2 x (0.5 - 2.5)				
flexible with uninsulated ferrule	mm ²	1 x (0.5 - 2.5), 2 x (0.5 - 2.5)				
flexible with ferrule to DIN 46228	mm ²	1 x (0.5 - 2.5), 2 x (0.5 - 1.5)				
solid, stranded or flexible	AWG	20 - 14				
Stripping length	mm	10				
Tool for opening the terminal	mm	3.0 x 0.5 slotted screwdriver				

Main circuits

Rated impulse withstand voltage	U_{imp}	V AC	6000	6000	6000	6000	6000
Rated operational voltage	U_e	V AC	690	690	690	690	690

AC

AC-1

Conventional thermal current

3-pole, 50 - 60 Hz

open							
up to 40 °C	$I_{th} = I_e$	A	22	22	22	22	22
up to 50 °C	$I_{th} = I_e$	A	21	21	21	21	21
up to 55 °C	$I_{th} = I_e$	A	21	21	21	21	21
up to 60 °C	$I_{th} = I_e$	A	20	20	20	20	20

AC-3

Rated operational current AC-3, 3-pole, 50 - 60 Hz

open							
220 V 230 V	I_e	A	7	9	12	15.5	12
380 V 400 V	I_e	A	7	9	12	15.5	12
660 V 690 V	I_e	A	4	5	7	9	7

AC-4

Rated operational current AC-3, 3-pole, 50 - 60 Hz

open							
220 V 230 V	I_e	A	5	6	7	7	7
380 V 400 V	I_e	A	5	6	7	7	7
660 V 690 V	I_e	A	4	4.5	5	5	5

Power drives

Voltage tolerance

AC-operated	Pick-up	x U_c	0.8 - 1.1				
AC-operated	Drop-out	x U_c	0.3 - 0.6				
DC-operated	Pick-up	x U_c	0.8 - 1.1				
DC-operated	Drop-out	x U_c	0.15 - 0.6				

IEC/EN 60947, VDE 0660, UL, CSA

10	10	10	10	10	10	10	10	10
10	10	10	10	10	10	10	10	10

1 x (1 - 6), 2 x (1 - 6)

1 x (1 - 10), 2 x (1 - 6)

1 x (1 - 6), 2 x (1 - 6)

1 x (1 - 6), 2 x (1 - 6)

1 x (1 - 6), 2 x (1 - 4)

18 - 8

12

3.0 x 0.5 slotted screwdriver

1 x (0.5 - 2.5), 2 x (0.5 - 2.5)

1 x (0.5 - 2.5), 2 x (0.5 - 2.5)

1 x (0.5 - 2.5), 2 x (0.5 - 2.5)

1 x (0.5 - 2.5), 2 x (0.5 - 2.5)

1 x (0.5 - 1.5), 2 x (0.5 - 1.5)

20 - 14

10

3.0 x 0.5 slotted screwdriver

8000	8000	8000	8000	8000	8000	8000	8000	8000
690	690	690	690	690	690	690	690	690

40	40	40	40	45	45	45	32	45
38	38	38	38	43	43	43	30	41
37	37	37	37	42	42	42	29	40
35	35	35	35	40	40	40	28	39

8	11	14	17	25	32	38	17	25
8	11	14	17	25	32	38	17	25
4	5	7	12	15	18	22.5	12	15

8	10	10	10	13	15	15	10	13
8	10	10	10	13	15	15	10	13
4	4.5	5	8	10	12	12	8	10

0.8 - 1.1

0.3 - 0.6

0.7 - 1.2

0.15 - 0.6

Technical data - DILA-...-PI contactor relay and auxiliary contact modules

DILM7-...-PI - DILM38-...-PI DILA-...-PI DILA-XHI...-PI DILM12-XHI...-PI DILM32-XHI...-PI

General information

Standards	IEC/EN 60947, EN 60947-5-1, VDE 0660, UL, CSA				
Connection cross-section of auxiliary circuits					
solid	mm ²	1 x (0.5 - 2.5), 2 x (0.5 - 2.5)			
flexible with ultrasonic welded busbar end	mm ²	1 x (0.5 - 2.5), 2 x (0.5 - 2.5)			
flexible without ferrule	mm ²	1 x (0.5 - 2.5), 2 x (0.5 - 2.5)			
flexible with uninsulated ferrule	mm ²	1 x (0.5 - 2.5), 2 x (0.5 - 2.5)			
flexible with ferrule to DIN 46228	mm ²	1 x (0.5 - 1.5), 2 x (0.5 - 1.5)*			
solid, stranded or flexible	AWG	20 - 14			
Stripping length	mm	10			
Tool for opening the terminal	mm	3.0 x 0.5 slotted screwdriver			

Circuits

Interlocked opposing contacts to EN 60947-5-1 (Appendix L) inside the auxiliary contact module	Yes				
An NC contact (not a late-breaking contact) is suitable for use as a mirror contact according to IEC/EN 60947-4-1 (Appendix F)	Yes				
Rated impulse withstand voltage	U_{imp}	V AC	6000	6000	6000
Rated operational voltage	U_e	V AC	500	500	500

Rated operational current

AC-15					
220/230/240 V	$I_{th} = I_e$	A	4	4	4
380/400/415 V	$I_{th} = I_e$	A	4	4	4
500 V	$I_{th} = I_e$	A	1.5	1.5	1.5
Contact reliability at $U_e = 24$ V DC, $U_{imp} = 5.4$ mA	Failure rate	λ	< 10 ⁻⁸ , < 1 failure per 100 million operations		

Power drives

Voltage tolerance					
AC-operated	Pick-up	x U_e	-	0.8 - 1.1	-
AC-operated	Drop-out	x U_e	-	0.3 - 0.6	-
DC-operated	Pick-up	x U_e	-	0.8 - 1.1	-
DC-operated	Drop-out	x U_e	-	0.15 - 0.6	-

Technical data - auxiliary contacts for PKZM0 motor-protective circuit breakers

NHI-E2-...-PI NHI11...-PI AGM2...-PI

General information

Standards	IEC/EN 60947, EN 60947-5-1, VDE 0660, UL, CSA				
Connection cross-section of auxiliary circuits					
solid	mm ²	1 x (0.5 - 2.5), 2 x (0.5 - 2.5)	1 x (0.5 - 2.5), 2 x (0.5 - 2.5)	1 x (0.5 - 2.5), 2 x (0.5 - 2.5)	
flexible with ultrasonic welded busbar end	mm ²	1 x (0.5 - 2.5), 2 x (0.5 - 2.5)	1 x (0.5 - 2.5), 2 x (0.5 - 2.5)	1 x (0.5 - 2.5), 2 x (0.5 - 2.5)	
flexible without ferrule	mm ²	1 x (0.5 - 1.5), 2 x (0.5 - 1.5)	1 x (0.5 - 2.5), 2 x (0.5 - 2.5)	1 x (0.5 - 2.5), 2 x (0.5 - 2.5)	
flexible with uninsulated ferrule	mm ²	1 x (0.5 - 1.5), 2 x (0.5 - 1.5)	1 x (0.5 - 2.5), 2 x (0.5 - 2.5)	1 x (0.5 - 2.5), 2 x (0.5 - 2.5)	
flexible with ferrule to DIN 46228	mm ²	1 x (0.5 - 1.5), 2 x (0.5 - 1.5)	1 x (0.5 - 1.5), 2 x (0.5 - 1.5)	1 x (0.5 - 1.5), 2 x (0.5 - 1.5)	
solid, stranded or flexible	AWG	20 - 14	20 - 14	20 - 14	
Stripping length	mm	8	10	10	
Tool for opening the terminal	mm	3.0 x 0.5 slotted screw driver			

Circuits

Rated impulse withstand voltage	U_{imp}	V AC	4000	6000	6000
Rated operational voltage	U_e	V AC	440	500	500
Rated operational current					
AC-15					
220/230/240 V	$I_{th} = I_e$	A	1	3.5	3.5
380/400/415 V	$I_{th} = I_e$	A		2	2
DC-13 L/R ≤ 100 ms					
24 V	$I_{th} = I_e$	A	2	2	2
Contact reliability at $U_e = 24$ V DC, $U_{imp} = 5.4$ mA	Failure rate	λ	< 10 ⁻⁸ , < 1 failure per 100 million operations		

*) 1 x (0,5 - 2,5), 2 x (0,5 - 1,5) für DILA-...-PI, DILM7(9)(12)(15)...-PI

Dimensions

Contactors with auxiliary contact module

DILA...-PI contactor relays with XHI...(-S)-PI auxiliary contacts

DILM7... (-PI) - DILM15...(-PI) contactors

with ...-XHI...(-S)-PI auxiliary contacts

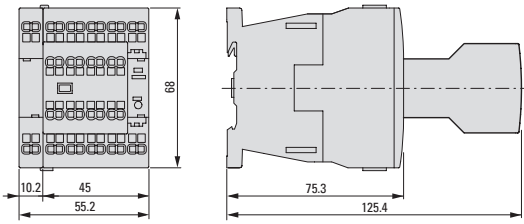

Contactors with auxiliary contact module

DILM8...-PI

DILM11...-PI

DILM14...-PI

DILM17...-PI

DILM25...-PI

DILM32...-PI

DILM38...-PI

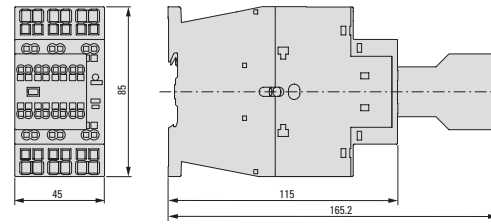

DILMP32(45)-...-PI

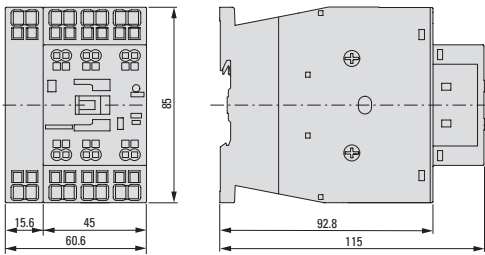

PKZM0... motor-protective circuit breakers with NHI-E2... auxiliary contacts

PKZM0...-PI
PKZM0...-T-PI

PKZM0...-SPI32

PKZM0...-SPI16

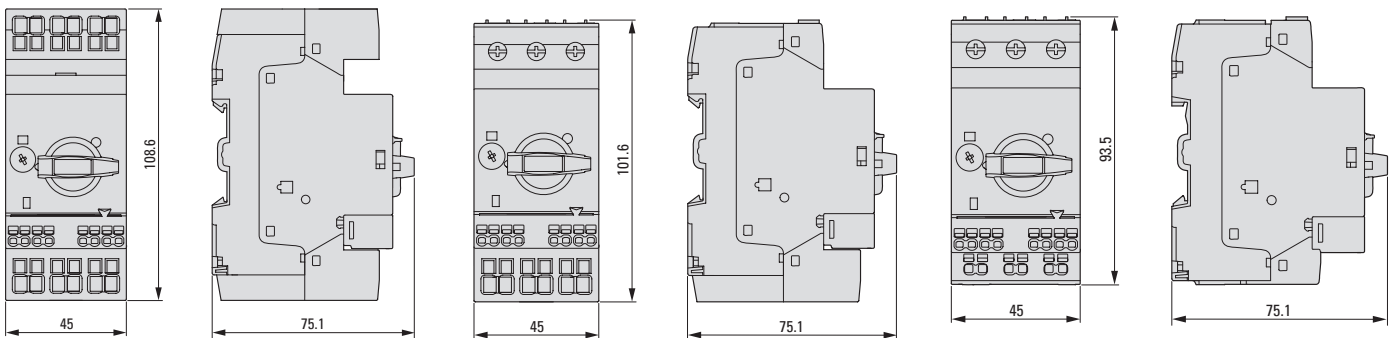

PKZM0 motor-protective circuit breakers

PKZM0...-PI+LSA-PKZ0-E-PI

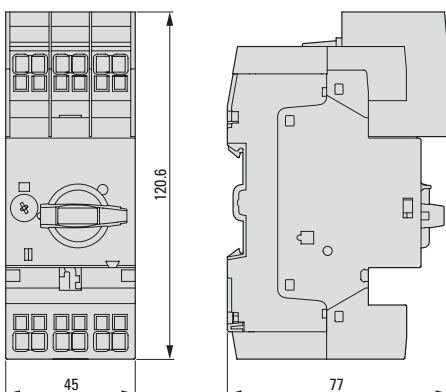

Standard auxiliary contacts

NHI...-PI

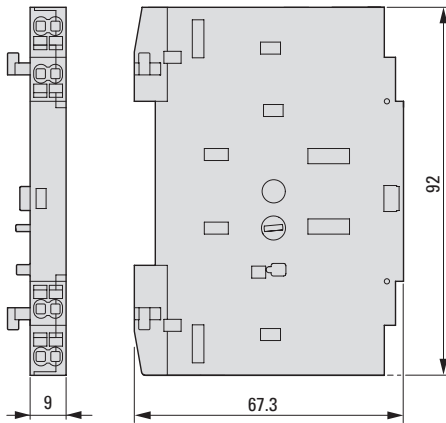

Trip indicators

AGM2...-PI

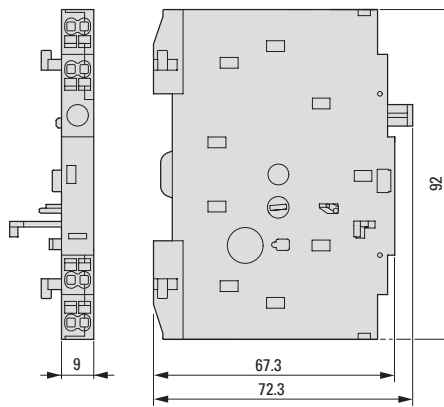

Shunt releases / undervoltage releases

A-PKZ0...-PI/ U-PKZ0...-PI

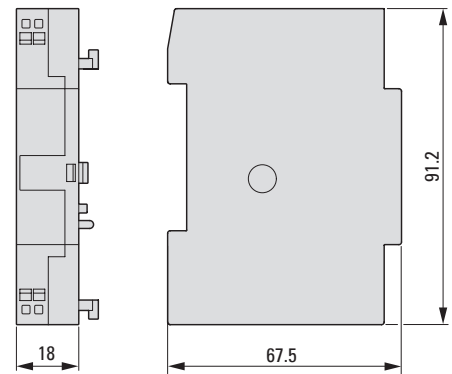

Motor-starter combinations

MSC-D...-DILM7 to -DILM15-PI

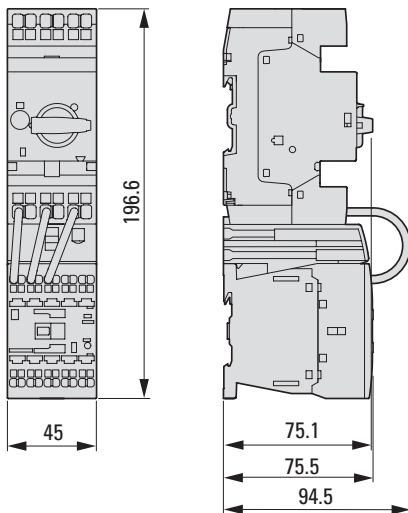

MSC-D...-DILM8, 11, 14, 17, 25, 32-PI

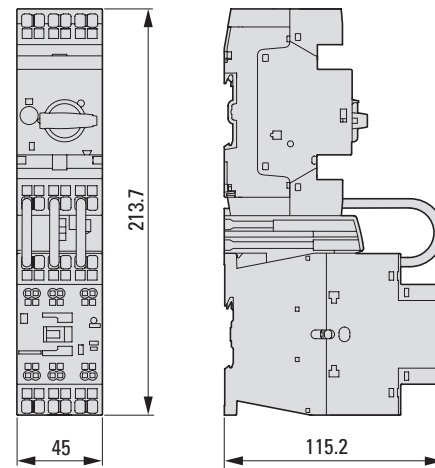

MSC-R...-DILM7 bis -DILM15-PI

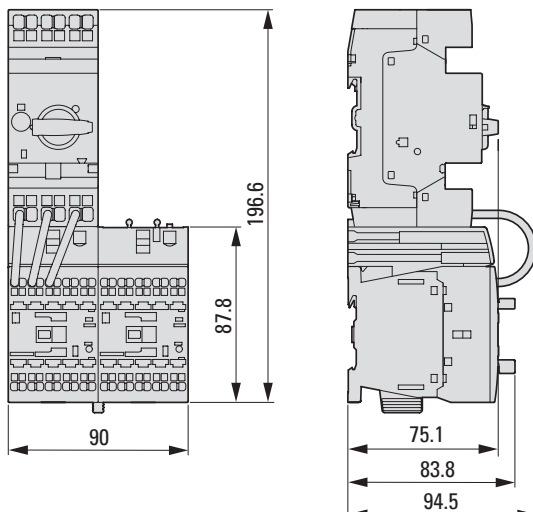

Eaton's mission is to improve the quality of life and the environment through the use of power management technologies and services. We provide sustainable solutions that help our customers effectively manage electrical, hydraulic, and mechanical power – more safely, more efficiently, and more reliably.

For more information, visit [Eaton.com](https://www.eaton.com).

The products, information and prices contained in this document are subject to change. The same is true for any errors or omissions. Only the order confirmation and the technical documentation received from Eaton are binding. Images and illustrations are indicative only and do not guarantee any particular design or functionality. Their use in any form must be approved in advance by Eaton. The same applies to Trademarks (especially Eaton, Moeller, Cutler-Hammer). Eaton's terms of sale, as published on Eaton's websites and included with order confirmations received from Eaton, apply.

Eaton Industries GmbH
Hein-Moeller-Str. 7-11
53115 Bonn/Germany
[Eaton.com](https://www.eaton.com)

© 2021 Eaton
All rights reserved
Publication No.: BR034012EN
April 2024

Eaton is a registered trademark of Eaton Corporation.

All other trademarks are property of their respective owners.

Follow us on social media to get the latest product and support information.

