

A solid and
reliable foundation

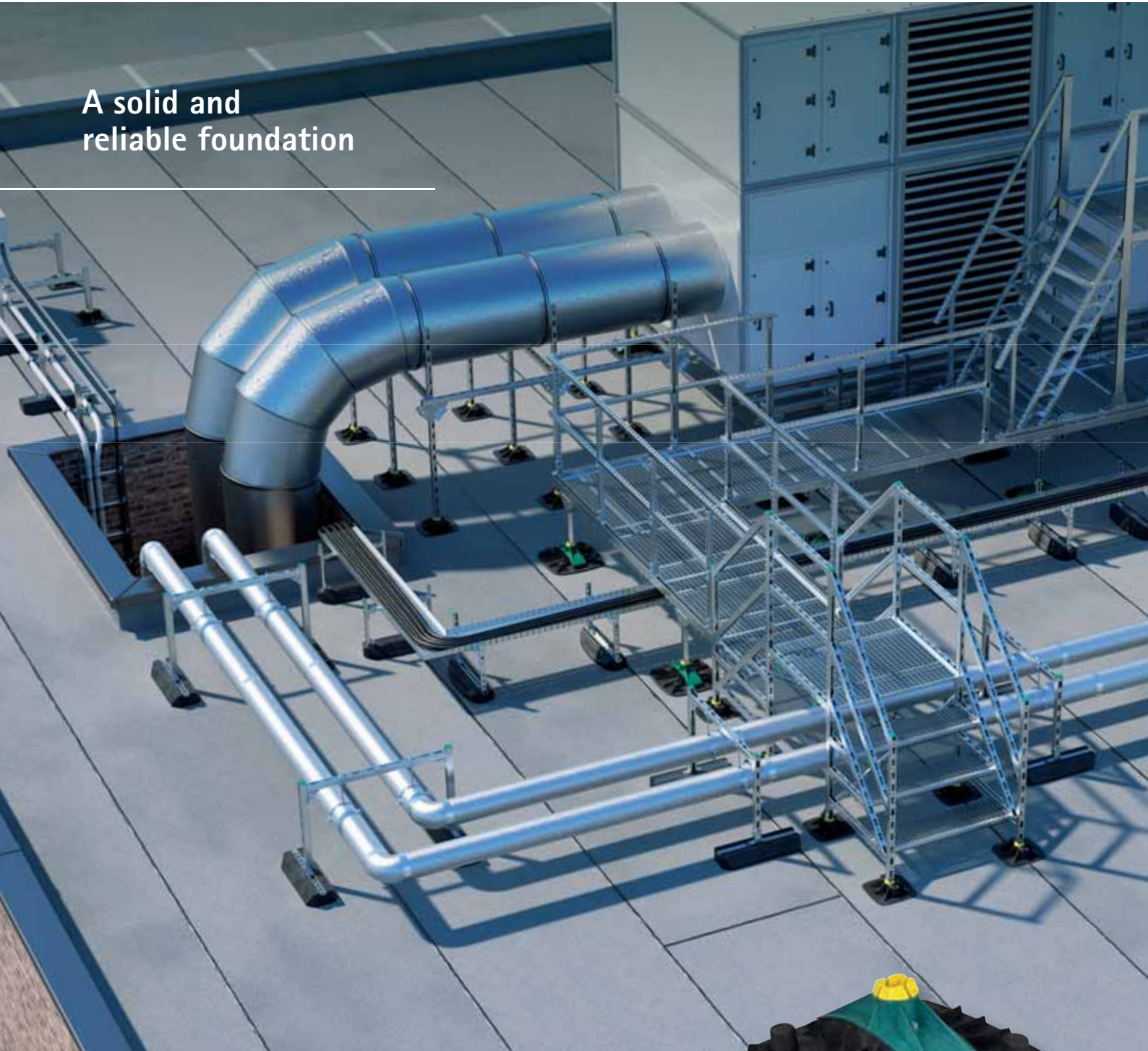

Walraven Yeti®

For any Strut based installation

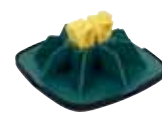

Walraven Yeti® 480

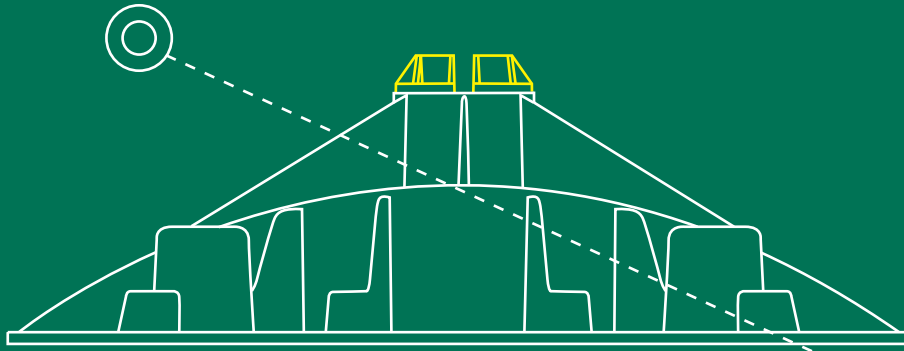

⊕ Adjustable to compensate roof pitch up to 7°



Walraven Yeti® 335

360° Rotatable ⊕ insert

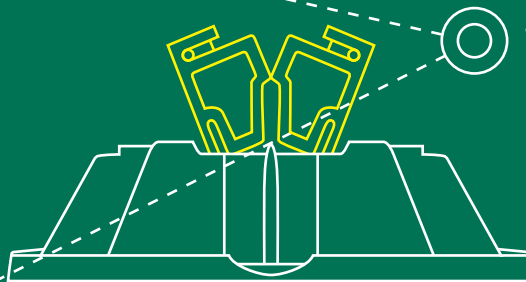

Walraven Yeti® 130

With unique ⊕ click-mechanism

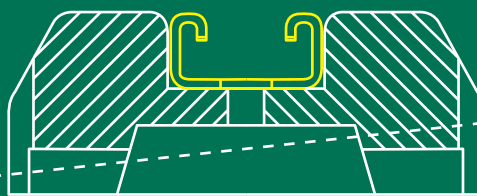

Walraven Ursus

⊕ Optimized load distribution

Inspired by smart solutions from the start

Walraven is your global partner in the installation market, founded in 1942. We have always been dedicated to making our clients' work easier, more effective, safer and more sustainable. With simple and smart solutions, comprehensive services and excellent support.

Walraven. The value of smart

Walraven Roof Support System

A solid and reliable foundation for any Strut based installation

Walraven Yeti® 480



Walraven Yeti® 480 is a non-penetrative, modular system for supporting installations on flat roofs, other flat surfaces and even on low pitched roofs (up to 7°). The sturdy Walraven Yeti® feet are used in combination with Walraven RapidStrut® fixing rail. With the optional ballast blocks extra weight can be added providing even greater stability. The Walraven Yeti® 480, available for both vertical and horizontal applications, is equipped with a non-slip, anti-vibration mat which prevents damage to the roof membrane, thereby minimising the risk of leakage.

Walraven Yeti® 335



The Walraven Yeti® 335 is the smaller family member of the Walraven Yeti® 480. It is designed to support installations on flat roofs or other flat surfaces, in combination with Walraven RapidStrut® fixing rail. The Walraven Yeti® 335, available for both vertical and horizontal applications, is supplied with a 360° rotatable insert, allowing precise positioning. It also comes with a non-slip, anti-vibration mat to prevent damage to the roof membrane.

Walraven Yeti® 130



A flexible and reliable foundation for light Strut based installations on roofs. It also comes with a non-slip, anti-vibration mat to prevent damage to the roof membrane.

Walraven Ursus Foot



Walraven Ursus is designed to support small, linear pipework systems, ductwork runs, cable trays and is ideal for climate installations, walkways and similar on flat roofs. The Walraven Ursus Foot Support System is made from UV resistant, vulcanised rubber, and includes a Walraven RapidStrut® fixing rail piece, with Walraven BIS UltraProtect® 1000 surface treatment.

Features and benefits



No drilling required

Prevents penetration of roof membrane and reduces the risk of leaks.



Recyclable

Mounting units are made from recycled weather and UV resistant materials.



Optimized load distribution

Optimal distribution of the load and reduction of dead weight protects the roof surface.



Saves time and money

Easy to use modular support system.



Sound & vibration proof

With non-slip anti-vibration mat.



SG Bauakustik

Nr. 1762-001-18



For flat and low pitched roofs and high loads

Walraven Yeti® 480

Adjustable for precise positioning and suitable for high loads



■ 360° rotatable insert



■ Adjustable to compensate roof pitch up to 7°



■ With non-slip anti-vibration mat



■ Optional stackable ballast block to increase stability

Technical data

Walraven Yeti® 480

Part No.	Model	Size
67685001	Vertical	480 x 480 mm
67685101	Horizontal	480 x 480 mm



Ballast Block

Part No.	Weight	In combination
67685401	8 kg	Walraven Yeti® 480



Mouldings made from WPC, a composite of recycled plastic and wood fibre.
Resistant to UV and chemical influences.

Maximum allowed loads

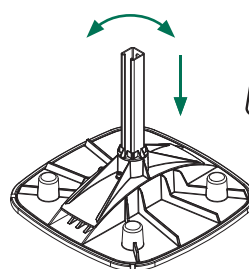

Tel. +44 (0)1295 75 34 00

walraven.com



The value of smart

Flexible application options with Walraven RapidStrut® System

- Combines with all Walraven Yeti® & Walraven Ursus products
- Extensive range of rails and accessories
- Fast and easy fixing
- Very high corrosion resistance

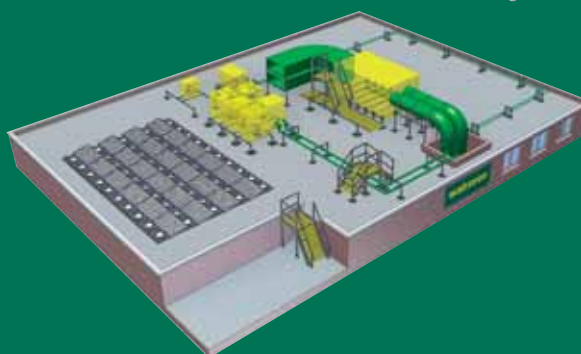

*For flat roofs,
for horizontal and
vertical applications*



Walraven Yeti® 335

Adjustable for precise positioning

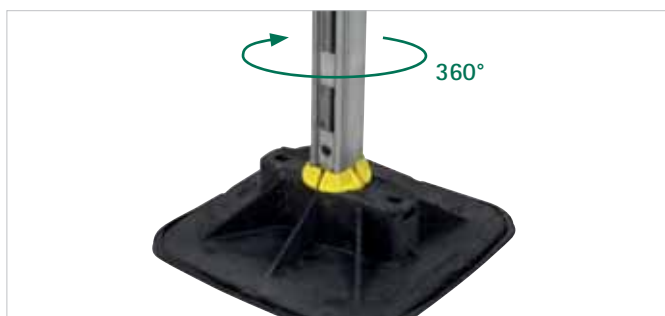

- 360° rotatable insert

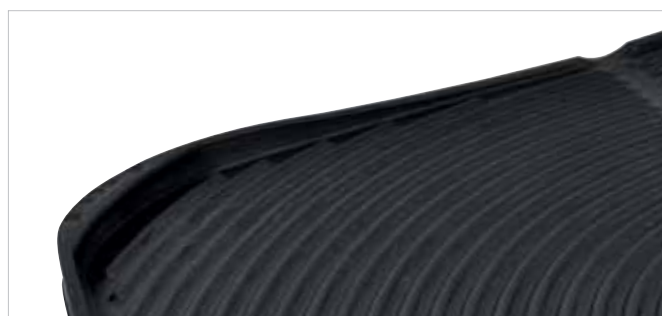

- With non-slip anti-vibration mat

Frame Set

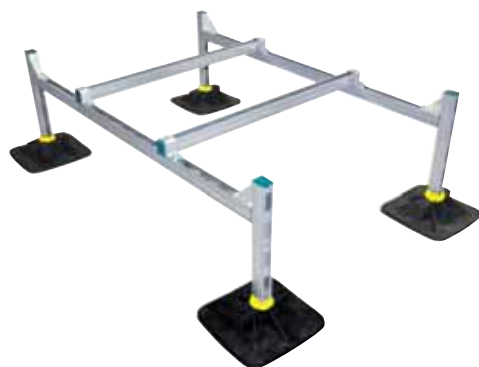

- Also available as a complete Frame-Set.
67685501

H-Set

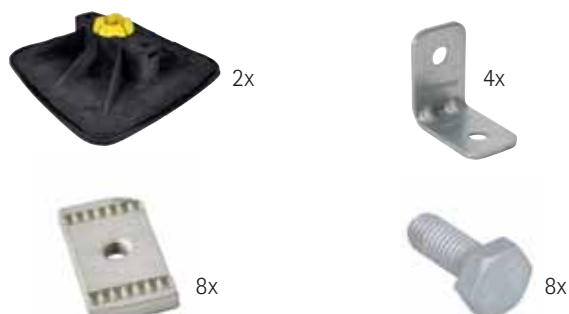

- Also available as H-Set (rails are not included).
67685302

Technical data

Walraven Yeti® 335

Part No.	Model	Size
67685201	For horizontal and vertical use	335 x 335 mm

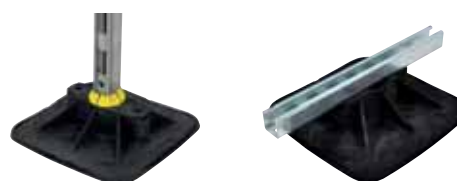

Mouldings made from WPC, a composite of recycled plastic and wood fibre. Resistant to UV and chemical influences.

Maximum allowed loads

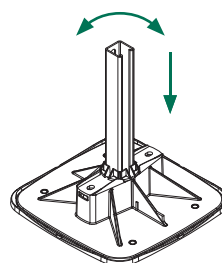

Tel. +44 (0)1295 75 34 00



walraven.com



*A flexible and reliable
foundation for light Strut based
installations on roofs*

Walraven Yeti® 130

With unique click-mechanism

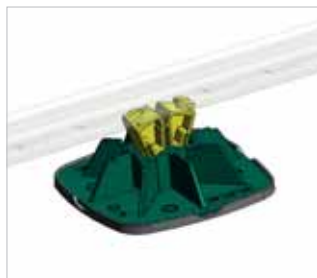

The insert is automatically closing when the rail gets pushed in

Features and benefits

- Suitable for light applications
- With unique click-mechanism
- With sound absorbing and non-slip anti-vibration mat
- Flexibility to use - build your solution
- Cost-effective but still high quality

Technical data

- Mouldings made from WPC, a composite of recycled plastic and wood fibre
- Made from 100% recycled plastic
- Resistant to UV and chemical influences
- 130 x 130 mm
- For horizontal and vertical use
- # 67685130
- Maximum load is 2500 N

Horizontal use

All Strut rails with standard hole pattern can be used, preferably 41 x 21 x 2,5 or 41 x 41x 2,5. You can build your own length of horizontal support.

Vertical use

Strut rails 41 x 21 can be used as H-construction for light weights, the adapter is not necessary, just push the rail into the body of Walraven Yeti® 130.

Applications



■ Duct Support



■ Pipe Support



■ Cable Tray Support



■ Step-overs / Walkways

Walraven BIS UltraProtect® 1000

Optimal protection

- All applied surface treatments effortlessly withstand a salt spray test of at least 1000 hours*
- Suitable for corrosive environments (C1–C4 in accordance with ISO 12944-2)



Better than Hot Dip Galvanizing

- Higher corrosion resistance: 1000 hours* versus 300 - 600 hours (with a layer thickness of 50 - 80 µm)
- Threaded products are also well protected
- Products feel smooth and are also visually appealing



Complementary system

- The products in the Walraven BIS UltraProtect® 1000 System combine together perfectly
- Can also be combined with zinc plated, pre-galvanized or hot dip galvanized products



*Until the occurrence of maximum 5% red rust.

The proof after 1000 hours salt spray test

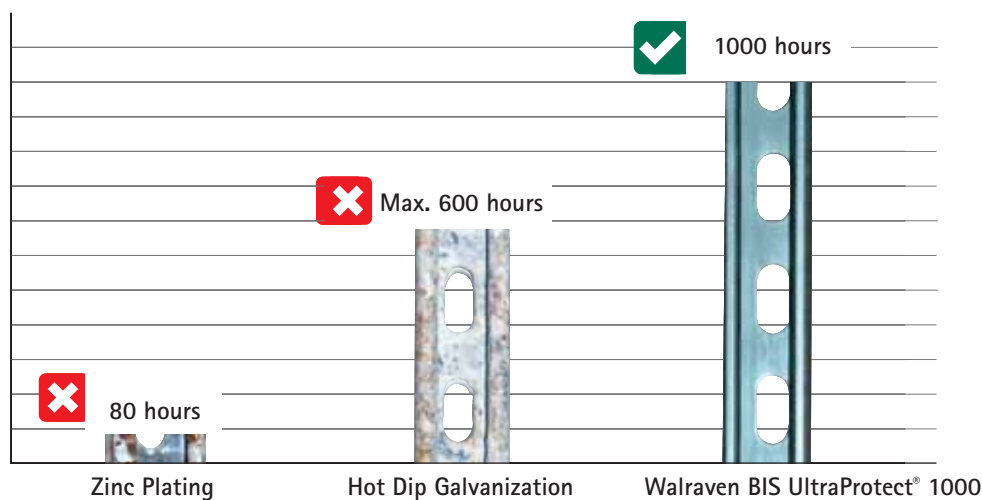



Corrosion resistance

- C1 - C4 / ISO 12944-2

Salt spray test

- 1000 hour / ISO 9227

Complementary system

- Perfect combination with other products



*For supporting small
pipework systems, ductwork
runs and cable trays*

Walraven Ursus Foot

For linear installation systems

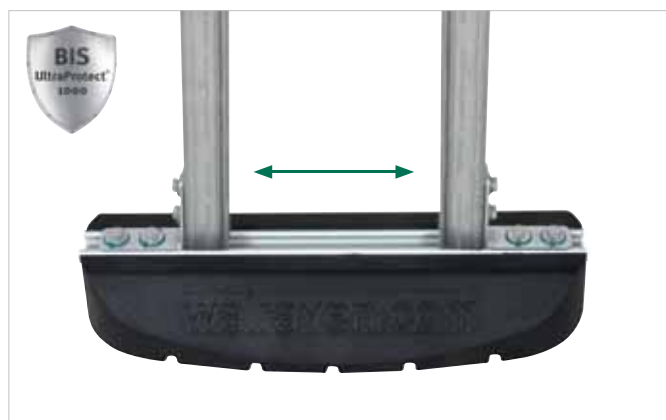

- For linear installation with Walraven RapidStrut® System

Technical data

- Material: vulcanized rubber, black
- Resistant to UV and chemical influences

1. Walraven Ursus 250 x 130 mm - # 67687250
2. Walraven Ursus 400 x 130 mm - # 67687400
3. Walraven Ursus 600 x 200 mm - # 67687601



1.



2.



3.

Maximum allowed loads*

The maximum allowed load is tested on a flat concrete surface under straight load. For technical support or advice on these products applied to anything other than concrete floors please contact our project engineers.

*In combination with Walraven RapidStrut® Channel.

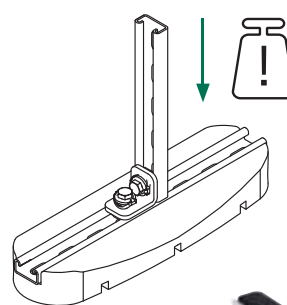

Fa,z
 1.000 N (# 67687250)
 2.000 N (# 67687400)
 3.000 N (# 67687601)

Walraven Yeti® 335 Hinge

For Rooftop Installations

Features and benefits

- Adjustable connector for rails
- Fully flexible in angle and direction due to rotatable insert in Yeti 335
- Material: steel 1.0332
- Suitable for in- and outdoor application

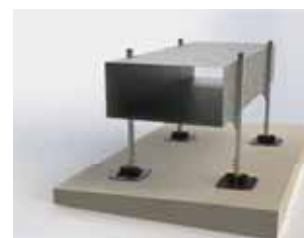
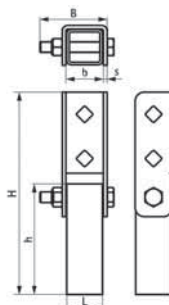

Technical data

Part No.	L	B (mm)	H (mm)	h (mm)	b (mm)	s (mm)
67685414	40	70	228	125	42	4

📞 Tel. +44 (0)1295 75 34 00

🌐 walraven.com

Find out how we can support you

Would you like to find out more about any of the solutions described in this brochure?

Or would you like to discuss how we could help you find the best possible solution for your project? Get in touch today!

Walraven Yeti® (EN) – 08/2025 – pdf – Full content subject to modifications
* The technical data are non-binding and do not reflect the warranted characteristics of the products. They are subject to change. Please consult our General Terms and Conditions. Additional information is available upon request. It is the designer's responsibility to select products suitable for the intended purpose and to ensure that performance data are not exceeded. The installation instructions should always be read and followed.

Other countries

Walraven International

Industrieweg 5
3641 RK Mijdrecht (NL)
Tel. +31 297 23 30 00
Fax +31 297 23 30 99
export@walraven.com

Walraven Group

Mijdrecht (NL) · Tienen (BE) · Bayreuth (DE) · Banbury (GB) · Malmö (SE) · Grenoble (FR) · Barcelona (ES)
Milan (IT) · Kraków (PL) · Mladá Boleslav (CZ) · Kyiv (UA) · Danville (US) · Dubai (AE) · Budapest (HU) · Mumbai (IN)
Singapore (SG) · Burlington (CA)

