

Data Sheet | Item Number: 280-510

Triple-deck terminal block; for DIN-rail 35 x 15 and 35 x 7.5; 2.5 mm²; CAGE CLAMP®; 2,50 mm²; green-yellow/blue/gray

<https://www.wago.com/280-510>

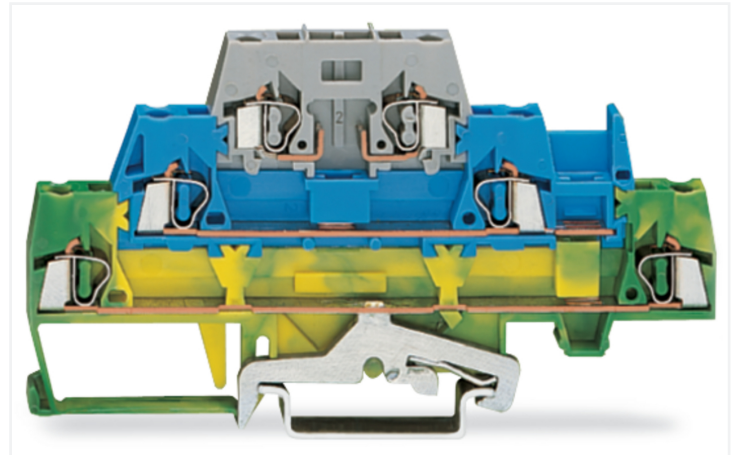
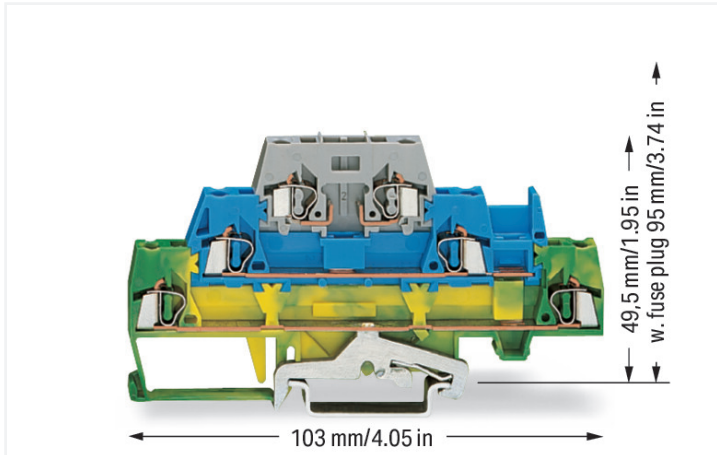

Color: ■ green-yellow/blue/gray

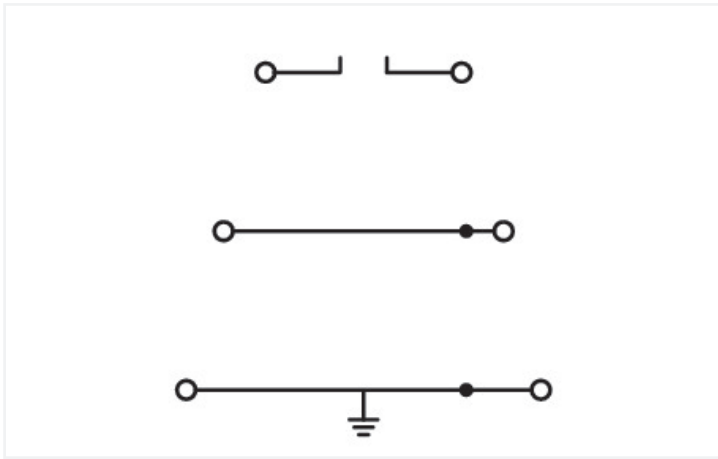

Similar to illustration

Triple-deck terminal block, 280 Series, CAGE CLAMP®

This triple-deck terminal block (item number 280-510) simplifies electrical installations. Strip lengths must be between 8 and 9 mm when connecting conductors to this triple-deck terminal block. The triple-deck terminal block also serves as carrier terminal block. This product features conductor terminals and utilizes CAGE CLAMP®. Our proven universal connection known as CAGE CLAMP® leads the way when it comes to connection technology and electrical interconnections. Depending on the conductor type, this triple-deck terminal block is designed for conductor cross sections ranging from 0.08 mm² to 2.5 mm².

Electrical data

Ratings per	IEC/EN 60947-7-1		
Overvoltage category	III	III	II
Pollution degree	3	2	2
Nominal voltage	400 V	-	-
Rated impulse withstand voltage	6 kV	-	-
Rated current	20 A	-	-

Power Loss

Power loss, per pole (potential)	0.532 W
Rated current I_N for power loss specification	20 A
Resistance value for specified, current-dependent power loss	0.00133 Ω

General information

Wiring direction	Front-entry wiring
------------------	--------------------

Connection Data

Clamping units	6
Total number of potentials	3
Number of levels	3

Connection 1

Connection technology	CAGE CLAMP®
Actuation type	Operating tool
Connectable conductor materials	Copper Aluminum

Connectable conductor materials (note) **Terminating Aluminum Conductors**
WAGO Spring-Clamp Terminal Blocks are suitable for solid aluminum conductors up to 4 mm²/12 AWG if WAGO "Alu-Plus" Contact Paste [249-130](#) is used for termination.

"Alu-Plus" Contact Paste Advantages:

- Automatically destroys the oxide film during clamping.
- Prevents fresh oxidation at the clamping point.
- Prevents electrolytic corrosion between aluminum and copper conductors (in the same terminal block).
- Provides long-term protection against corrosion.

Using terminal blocks with CAGE CLAMP® Spring Pressure Connection Technology, **aluminum conductors must first be cleaned with a blade** and then immediately inserted into the clamping units filled with "Alu-Plus" contact paste.

It is also possible to apply WAGO "Alu-Plus" **additionally** on the whole surface of the aluminum conductor before termination.

Please note that the nominal currents must be adapted to the reduced conductivity of the aluminum conductors:
2.5 mm² = 16 A
4 mm² = 22 A

Solid conductor	0.08 ... 2.5 mm ² / 28 ... 12 AWG
Fine-stranded conductor	0.08 ... 2.5 mm ² / 28 ... 12 AWG
Note (conductor cross-section)	12 AWG: THHN, THWN
Strip length	8 ... 9 mm / 0.31 ... 0.35 inches
Wiring direction	Front-entry wiring

Physical data

Width	5 mm / 0.197 inches
Height	103 mm / 4.055 inches
Depth from upper-edge of DIN-rail	49.5 mm / 1.949 inches

Mechanical data

Design	horizontal type
Mounting type	DIN-35 rail
Marking level	without marking level

Material data

Note (material data)	Information on material specifications can be found here
Color	green-yellow/blue/gray
Material group	I
Insulation material (main housing)	Polyamide (PA66)
Flammability class per UL94	V0
Fire load	0.259 MJ
Weight	21.3 g

Environmental requirements

Processing temperature	-35 ... +85 °C
Continuous operating temperature	-60 ... +105 °C

Commercial data

Product Group	1 (Rail Mounted Terminal Blocks)
PU (SPU)	50 pcs
Packaging type	Box
Country of origin	CN
GTIN	4050821293552
Customs tariff number	85369010000

Product Classification

UNSPSC	39121410
eCl@ss 10.0	27-14-11-41
eCl@ss 9.0	27-14-11-41
ETIM 9.0	EC000901
ETIM 10.0	EC000901
ECCN	NO US CLASSIFICATION

Environmental Product Compliance

CAS-No.	7439-92-1
REACH Candidate List Substance	Lead
RoHS Compliance Status	Compliant, No Exemption
SCIP notification number (Austria)	6ed98591-756f-4f94-9c0b-debd0a59ee07
SCIP notification number (Belgium)	1474dd91-4d99-44bb-8ba4-46e16c36ae78
SCIP notification number (Bulgaria)	97f75d78-4439-4a94-9cfd-74f978460604
SCIP notification number (Czech Republic)	d5fc19bf-567e-4dd0-b56e-2e20caf01d0e
SCIP notification number (Denmark)	0442b196-1414-476a-9fe4-75c635605326
SCIP notification number (Finland)	70b18fd2-4201-4ea0-a076-1adfc7fa8699
SCIP notification number (France)	424c9ee6-29c7-4292-a120-026cede32c4c
SCIP notification number (Germany)	4ff53ca3-4137-459b-adc3-9d5c087415f7
SCIP notification number (Hungary)	820fafcf-3a67-486a-af31-0273c3b376ec
SCIP notification number (Italy)	892280af-3b6d-4292-95aa-3112ddf9437a
SCIP notification number (Netherlands)	2aae21cb-3cd3-4ccb-b992-d0427a7d8f29
SCIP notification number (Poland)	3fd85a4f-eea2-4242-a886-7678a5f951a3
SCIP notification number (Romania)	5b865202-f7a3-4fa3-8160-5367a02f566d
SCIP notification number (Sweden)	1d6fb3dd-6512-41dc-ac30-879c9b226a47

Approvals / Certificates

General approvals



Approval	Standard	Certificate Name
CSA DEKRA Certification B.V.	C22.2	1536071
KEMA/KEUR DEKRA Certification B.V.	EN 60947	71-154769
UR Underwriters Laboratories Inc.	UL 1059	E45172

Declarations of conformity and manufacturer's declarations

Approval	Standard	Certificate Name
EU-Declaration of Conformity WAGO GmbH & Co. KG	-	-
UK-Declaration of Conformity WAGO GmbH & Co. KG	-	-

Approvals for marine applications



Approval	Standard	Certificate Name
ABS American Bureau of Shipping	EN 60947	24-0152298-PDA
BV Bureau Veritas S.A.	EN 60947	07436/G0 BV
DNV GL Det Norske Veritas, Germanischer Lloyd	-	TAE00001V2

Downloads

Environmental Product Compliance

Compliance Search

Environmental Product Compliance 280-510



Documentation

Bid Text

280-510	19.02.2019	xml 3.61 KB	
280-510	02.03.2017	doc 25.00 KB	

CAD/CAE-Data

CAD data	CAE data
2D/3D Models 280-510	EPLAN Data Portal 280-510
	WSCAD Universe 280-510
	ZUKEN Portal 280-510

1 Compatible Products

1.1 Required Accessories

1.1.1 End plate

1.1.1.1 End plate



Item No.: 280-303
End and intermediate plate; 2.5 mm thick; gray



Item No.: 280-304
End and intermediate plate; 2.5 mm thick; orange



Item No.: 280-336
Intermediate plate; 1.1 mm thick; orange

1.2 Optional Accessories

1.2.1 DIN-rail

1.2.1.1 Mounting accessories



Item No.: 210-196
Aluminum carrier rail; 35 x 8.2 mm; 1.6 mm thick; 2 m long; unslotted; similar to EN 60715; silver-colored



Item No.: 210-198
Copper carrier rail; 35 x 15 mm; 2.3 mm thick; 2 m long; unslotted; according to EN 60715; copper-colored



Item No.: 210-508
Steel carrier rail; 35 x 15 mm; 1.5 mm thick; 2 m long; slotted; galvanized; similar to EN 60715; silver-colored



Item No.: 210-197
Steel carrier rail; 35 x 15 mm; 1.5 mm thick; 2 m long; slotted; similar to EN 60715; silver-colored



Item No.: 210-506
Steel carrier rail; 35 x 15 mm; 1.5 mm thick; 2 m long; unslotted; galvanized; similar to EN 60715; silver-colored



Item No.: 210-114
Steel carrier rail; 35 x 15 mm; 1.5 mm thick; 2 m long; unslotted; similar to EN 60715; silver-colored



Item No.: 210-118
Steel carrier rail; 35 x 15 mm; 2.3 mm thick; 2 m long; unslotted; according to EN 60715; silver-colored



Item No.: 210-115
Steel carrier rail; 35 x 7.5 mm; 1 mm thick; 2 m long; slotted; according to EN 60715; "Hole width 18 mm; silver-colored



Item No.: 210-112
Steel carrier rail; 35 x 7.5 mm; 1 mm thick; 2 m long; slotted; according to EN 60715; "Hole width 25 mm; silver-colored



Item No.: 210-504
Steel carrier rail; 35 x 7.5 mm; 1 mm thick; 2 m long; slotted; galvanized; according to EN 60715; silver-colored



Item No.: 210-113
Steel carrier rail; 35 x 7.5 mm; 1 mm thick; 2 m long; unslotted; according to EN 60715; silver-colored



Item No.: 210-505
Steel carrier rail; 35 x 7.5 mm; 1 mm thick; 2 m long; unslotted; galvanized; according to EN 60715; silver-colored

1.2.2 Ferrule

1.2.2.1 Ferrule



Item No.: 216-301

Ferrule; Sleeve for 0.25 mm² / AWG 24; insulated; electro-tin plated; yellow



Item No.: 216-302

Ferrule; Sleeve for 0.34 mm² / 22 AWG; insulated; electro-tin plated; light turquoise



Item No.: 216-201

Ferrule; Sleeve for 0.5 mm² / 20 AWG; insulated; electro-tin plated; electrolytic copper; acc. to DIN 46228, Part 4/09.90; white



Item No.: 216-101

Ferrule; Sleeve for 0.5 mm² / AWG 22; un-insulated; electro-tin plated; silver-colored



Item No.: 216-202

Ferrule; Sleeve for 0.75 mm² / 18 AWG; insulated; electro-tin plated; gray



Item No.: 216-102

Ferrule; Sleeve for 0.75 mm² / AWG 20; un-insulated; electro-tin plated; silver-colored



Item No.: 216-203

Ferrule; Sleeve for 1 mm² / AWG 18; un-insulated; electro-tin plated; red



Item No.: 216-103

Ferrule; Sleeve for 1 mm² / AWG 18; un-insulated; electro-tin plated



Item No.: 216-204

Ferrule; Sleeve for 1.5 mm² / AWG 16; un-insulated; electro-tin plated; black



Item No.: 216-104

Ferrule; Sleeve for 1.5 mm² / AWG 16; un-insulated; electro-tin plated; silver-colored

1.2.3 Installation

1.2.3.1 Cover



Item No.: 709-154

Cover; Type 2; suitable for cover carrier, type 2; 1 m long; transparent

1.2.3.2 Cover carrier



Item No.: 709-168

Cover carrier; Type 2; incl. fixing/retaining screws and knurled nut; suitable for 283 to 285 Series rail-mounted terminal blocks; suitable for 279 to 281 Series double- and triple-deck terminal blocks; suitable for 780 to 785, 775, 776 and 777 Series TOP-JOB® rail-mounted terminal blocks; suitable for 280 Series sensor and actuator terminal blocks; suitable for 282 Series disconnect/test terminal blocks for transformer circuits; gray

1.2.3.3 Mounting accessories



Item No.: 209-106

Mounting carrier; for isolated mounting on DIN 35 rails; gray



Item No.: 249-116

Screwless end stop; 6 mm wide; for DIN-rail 35 x 15 and 35 x 7.5; gray

1.2.4 Insulation stop

1.2.4.1 Insulation stop



Item No.: 280-470
Insulation stop; 0.08 - 0.2 mm² "s" (0.14 mm² "f-st"); 5 pieces/strip; white



Item No.: 280-471
Insulation stop; 0.25 - 0.5 mm²; 5 pieces/strip; light gray



Item No.: 280-472
Insulation stop; 0.75 - 1 mm²; 5 pieces/strip; black

1.2.5 Jumper

1.2.5.1 Jumper



Item No.: 280-490
Jumper; 10-way; insulated; gray



Item No.: 280-482
Jumper; 2-way; insulated; gray



Item No.: 280-492
Jumper; 2-way; insulated; gray



Item No.: 280-483
Jumper; 3-way; insulated; gray



Item No.: 280-484
Jumper; 4-way; insulated; gray



Item No.: 280-485
Jumper; 5-way; insulated; gray



Item No.: 280-402
Jumper; insulated; gray



Item No.: 280-409
Jumper; insulated; gray



Item No.: 780-452
Staggered jumper; from 1 to 2; insulated; gray



Item No.: 780-453
Staggered jumper; from 1 to 3; insulated; gray



Item No.: 780-454
Staggered jumper; from 1 to 4; insulated; gray



Item No.: 780-455
Staggered jumper; from 1 to 5; insulated; gray



Item No.: 780-456
Staggered jumper; from 1 to 6; insulated; gray



Item No.: 780-457
Staggered jumper; from 1 to 7; insulated; gray



Item No.: 780-458
Staggered jumper; from 1 to 8; insulated; gray



Item No.: 281-421
Vertical jumper; insulated; gray



Item No.: 709-110
Wire commoning chain; 2.5 mm²; insulated; black



Item No.: 709-111
Wire commoning chain; 2.5 mm²; insulated; black



Item No.: 709-112
Wire commoning chain; 2.5 mm²; insulated; black



Item No.: 210-103
Wire commoning chain; insulated; black



Item No.: 210-123
Wire commoning chain; insulated; blue

1.2.6 Marking

1.2.6.1 Marker



Item No.: 793-5501
WMB marking card; as card; for terminal block width 5 - 17.5 mm; stretchable 5 - 5.2 mm; plain; snap-on type; white



Item No.: 793-501
WMB marking card; as card; not stretchable; plain; snap-on type; white



Item No.: 2009-115
WMB-Inline; for Smart Printer; 1500 pieces on roll; stretchable 5 - 5.2 mm; plain; snap-on type; white

1.2.7 Plug

1.2.7.1 Fuse plug



Item No.: 281-512/281-418

Fuse plug; with pull-tab; for miniature metric fuses 5 x 20 mm and 5 x 25 mm; with blown fuse indication by neon lamp; 120 V; 6 mm wide; gray



Item No.: 281-512/281-417

Fuse plug; with pull-tab; for miniature metric fuses 5 x 20 mm and 5 x 25 mm; with blown fuse indication by neon lamp; 230 V; 6 mm wide; gray



Item No.: 281-512/281-501

Fuse plug; with pull-tab; for miniature metric fuses 5 x 20 mm and 5 x 25 mm; with LED indicator; 24 V AC/DC; 6 mm wide; gray



Item No.: 281-512

Fuse plug; with pull-tab; for miniature metric fuses 5 x 20 mm and 5 x 25 mm; with port for LED; 6 mm wide; gray



Item No.: 281-511

Fuse plug; with pull-tab; for miniature metric fuses 5 x 20 mm and 5 x 25 mm; without blown fuse indication; 6 mm wide; gray



Item No.: 280-854

Fuse plug; with soldered miniature fuse; 1 A FF; 5 mm wide; gray



Item No.: 280-856

Fuse plug; with soldered miniature fuse; 2 A FF; 5 mm wide; gray



Item No.: 280-850

Fuse plug; with soldered miniature fuse; 250 mA FF; 5 mm wide; gray



Item No.: 280-852

Fuse plug; with soldered miniature fuse; 500 mA FF; 5 mm wide; gray



Item No.: 280-854/281-415

Fuse plug; with soldered miniature fuse; with indicator lamp; LED (red); AC 15 - 30 V; 1 A FF; 5 mm wide; gray



Item No.: 280-856/281-415

Fuse plug; with soldered miniature fuse; with indicator lamp; LED (red); AC 15 - 30 V; 2 A FF; 5 mm wide; gray



Item No.: 280-850/281-415

Fuse plug; with soldered miniature fuse; with indicator lamp; LED (red); AC 15 - 30 V; 250 mA FF; 5 mm wide; gray



Item No.: 280-852/281-415

Fuse plug; with soldered miniature fuse; with indicator lamp; LED (red); AC 15 - 30 V; 500 mA FF; 5 mm wide; gray



Item No.: 280-854/281-413

Fuse plug; with soldered miniature fuse; with indicator lamp; LED (red); DC 15 - 30 V; 1 A FF; 5 mm wide; gray



Item No.: 280-856/281-413

Fuse plug; with soldered miniature fuse; with indicator lamp; LED (red); DC 15 - 30 V; 2 A FF; 5 mm wide; gray



Item No.: 280-850/281-413

Fuse plug; with soldered miniature fuse; with indicator lamp; LED (red); DC 15 - 30 V; 250 mA FF; 5 mm wide; gray



Item No.: 280-852/281-413

Fuse plug; with soldered miniature fuse; with indicator lamp; LED (red); DC 15 - 30 V; 500 mA FF; 5 mm wide; gray



Item No.: 280-854/281-414

Fuse plug; with soldered miniature fuse; with indicator lamp; LED (red); DC 30 - 65 V; 1 A FF; 5 mm wide; gray



Item No.: 280-856/281-414

Fuse plug; with soldered miniature fuse; with indicator lamp; LED (red); DC 30 - 65 V; 2 A FF; 5 mm wide; gray



Item No.: 280-850/281-414

Fuse plug; with soldered miniature fuse; with indicator lamp; LED (red); DC 30 - 65 V; 250 mA FF; 5 mm wide; gray



Item No.: 280-852/281-414

Fuse plug; with soldered miniature fuse; with indicator lamp; LED (red); DC 30 - 65 V; 500 mA FF; 5 mm wide; gray

1.2.8 Protective warning marker

1.2.8.1 Cover



Item No.: 280-415

Protective warning marker; for 5 terminal blocks; with high-voltage symbol, black; yellow

1.2.9 Push-in type wire jumper

1.2.9.1 Jumper



Item No.: 249-126

Push-in type wire jumper; 0.75 mm²; insulated; 110 mm long; black



Item No.: 249-123

Push-in type wire jumper; 0.75 mm²; insulated; 180 mm long; black



Item No.: 249-127

Push-in type wire jumper; 0.75 mm²; insulated; 250 mm long; black



Item No.: 249-125

Push-in type wire jumper; insulated; 60 mm long; black

1.2.10 Test and measurement

1.2.10.1 Testing accessories



Item No.: 249-142

L-type end module; modular; with rigid contact pin; End module; 1,50 mm²; gray



Item No.: 249-141

L-type test plug module; modular; with spring-loaded contact pin; Center module; 1,50 mm²; gray

1.2.11 Tool

1.2.11.1 Operating tool



Item No.: 210-658

Operating tool; Blade: 3.5 x 0.5 mm; with a partially insulated shaft; angled; short; multicoloured



Item No.: 210-720

Operating tool; Blade: 3.5 x 0.5 mm; with a partially insulated shaft; multicoloured



Item No.: 210-657

Operating tool; Blade: 3.5 x 0.5 mm; with a partially insulated shaft; short; multicoloured

Installation Notes

Installation

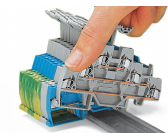

Snapping a terminal block onto the DIN-rail.

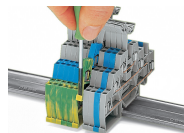

Removing a terminal block from the assembly.

Conductor termination

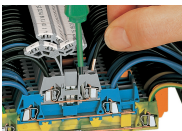

CAGE CLAMP® connection

Inserting a conductor.

With ferruled conductors, it is necessary to use a terminal block one size smaller than the conductor's nominal cross-section.

Commoning

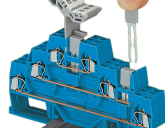
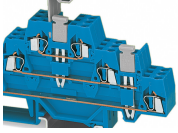

A vertical jumper commons the upper and lower decks, creating a 6-conductor feed-through terminal block in one housing. Two adjacent triple-deck terminal blocks may be commoned together on the same deck using a push-in adjacent jumper.

Combining vertical and adjacent jumpers.

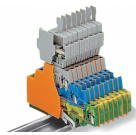
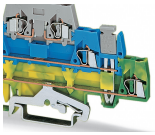

Grounding to DIN-rail:
Connecting N-level to ground level via vertical jumper.

When triple-deck terminal blocks are used with a fuse plug (6 mm wide) in the receptacle (top) level, the extra width of the 280 Series (5 mm wide) can be compensated for via intermediate plates (1.1 mm thick).

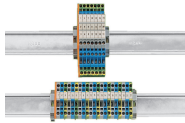

Use 67% less rail space with triple-deck terminal blocks.

Marking



Labeling via WMB Multi Marking System.