

Edition 11

31266850100 Waschtischunterbau

**PRODUKT**

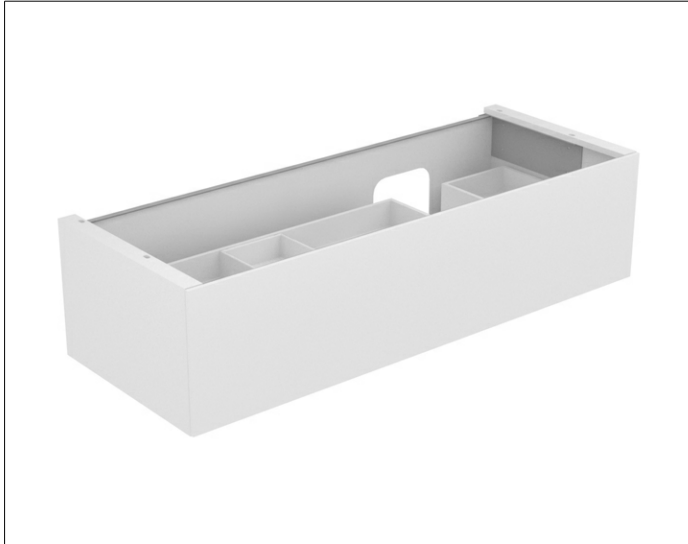

**ZEICHNUNG**

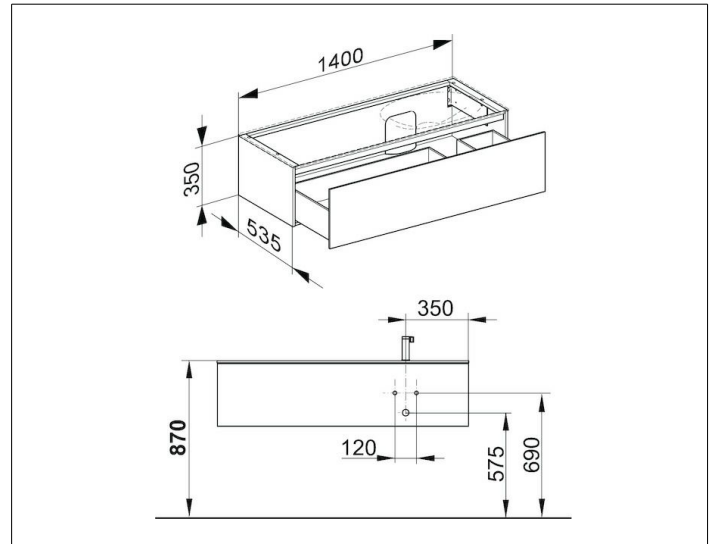

EEK: F , 10 kWh/1000h

**OBERFLÄCHE**

Tabak-Eiche Furnier/Tabak-Eiche Furnier

**ABMESSUNG**

1400 x 350 x 535 mm