

# Productinformatieblad

Specificaties



## Druknop, Harmony XB4, metaal, Vlak, groen, 22mm, veerretour, wit gemarkeerd I, 1 NO, compacte Push-in

XB4BA33115

EAN Code: 3606480360749

### Hoofd

range of product	Harmony XB4
device short name	XB4
product or component type	Druknop
kraag materiaal	Verchroomd metaal
materiaal bevestigingskraag	Zamak
bevestigingsdiameter	22,5 mm
verkoop per ondeelbare hoeveelheid	1
vorm van kop signaleringseenheid	Rond
type operator	terugverend
operator profiel	Groen verzonken, I (wit)
koptype	Standaard
type en samenstelling contacten	1 NO
werking contacten	Slow-break
aansluitingen - aansluitklemmen	Insteek, $\leq 2 \times 1,5 \text{ mm}^2$ met kabeluiteinde met aansluitflensbus conform aan IEC 60947-1 Insteek, $\geq 1 \times 0,34 \text{ mm}^2$ zonder draadeinddop conform aan IEC 60947-1

### Complementair

height	47 mm
width	30 mm
depth	43,2 mm
beschrijving klemmen ISO n°1	(13-14)NO
net weight	0,076 kg
weerstand hoge druk drukkring	7000000 Pa bij 55 °C, afstand: 0.1 m
contact gebruik	Standaardcontacten
positieve opening	Zonder
bedrijfstraject	2,05 mm (normaal open elektrische status wijzigen) 4,3 mm (totale reis)
bedieningskracht	2,45 N normaal open elektrische status wijzigen
mechanical durability	10000000 cycles
contact materiaal	Zilverlegering (Ag/Ni)
kortsluitbeveiliging	10 A smeltpatroon type gG conform aan IEC 60947-5-1

De weergegeven prijs is de adviesprijs in euro excl. BTW. Deze kan onderhevig zijn aan korting. Neem contact op met uw lokale distributeur of detailhandel voor de daadwerkelijke prijs

<b>lth conventionele thermische stroom in vrije lucht</b>	10 A conform aan IEC 60947-5-1
<b>Ui nom isolatiespanning</b>	300 V (vervuilingsgraad 3) conform aan IEC 60947-1
<b>Uimp nom. schokgolfspanning</b>	4 kV conform aan IEC 60947-1
<b>le nom. bedrijfstrom</b>	6 A bij 120 V, AC-15, A300 conform aan IEC 60947-5-1 3 A bij 240 V, AC-15, A300 conform aan IEC 60947-5-1 0,55 A bij 125 V, DC-13, Q300 conform aan IEC 60947-5-1 0,27 A bij 250 V, DC-13, Q300 conform aan IEC 60947-5-1
<b>product presentatie</b>	Compleet product

## Omgeving

<b>beschermende behandeling</b>	TH
<b>ambient air temperature for storage</b>	-40...70 °C
<b>ambient air temperature for operation</b>	-40...70 °C
<b>overvoltage category</b>	Klasse I conforming to IEC 60536
<b>IP beschermingsgraad</b>	IP66 conform aan IEC 60529 IP67 IP69 IP69K
<b>NEMA beschermingsgraad</b>	NEMA 13 NEMA 4X
<b>IK-beschermingsgraad</b>	IK06 conforming to IEC 50102
<b>standards</b>	IEC 60947-1 IEC 60947-5-1 IEC 60947-5-4 IEC 60947-5-5 UL 60947-1 UL 60947-5-1 UL 60947-5-5 UL 1059 UL 486E CSA C22.2 Nr 60947-1 CSA C22.2 Nr 60947-5-1 CSA C22.2 Nr. 158 CSA C22.2 Nr 65 IACS E10
<b>product certifications</b>	EAC ECEE CB-regeling CCC UL CSA
<b>trilling bestendigheid</b>	5 gn (f= 10...500 Hz) conforming to IEC 60068-2-6 25 mm piek-piek (f= 2...10 Hz) conforming to IEC 60068-2-6
<b>schokbestendigheid</b>	25 gn (duur = 6 ms) voor 1000 schokken op elke as conform aan IEC 60068-2-27 30 gn (duur = 18 ms) voor halve sinusgolf versnelling conform aan IEC 60068-2-27 50 gn (duur = 11 ms) voor halve sinusgolf versnelling conform aan IEC 60068-2-27

## Verpakkingseenheid

<b>Unit Type of Package 1</b>	PCE
<b>Number of Units in Package 1</b>	1
<b>Package 1 Height</b>	3,000 cm
<b>Package 1 Width</b>	5,000 cm
<b>Package 1 Length</b>	8,500 cm
<b>Package 1 Weight</b>	79,000 g
<b>Unit Type of Package 2</b>	S02

<b>Number of Units in Package 2</b>	50
<b>Package 2 Height</b>	15,000 cm
<b>Package 2 Width</b>	30,000 cm
<b>Package 2 Length</b>	40,000 cm
<b>Package 2 Weight</b>	4,210 kg
<b>Unit Type of Package 3</b>	P06
<b>Number of Units in Package 3</b>	800
<b>Package 3 Height</b>	75,000 cm
<b>Package 3 Width</b>	80,000 cm
<b>Package 3 Length</b>	60,000 cm
<b>Package 3 Weight</b>	75,360 kg

## Environmental Data

Schneider Electric wil tegen 2050 de Net Zero-status hebben bereikt via partnerschappen in de toeleveringsketen, materialen met een lagere impact en circulariteit via onze doorlopende campagne "Use Better, Use Longer, Use Again" om de levensduur van producten en de recycleerbaarheid te verlengen.

[Uitleg van Environmental Data](#) >

[Hoe evalueren we de duurzaamheid van producten?](#) >

### Milieuoetafdruk

Totale levenscyclus ecologische voetafdruk 1

Milieuprofiel van product (PEP) [Milieuprofiel van het product](#)

## Use Better

### Materialen en verpakking

Pakket met gerecycleerd karton Ja

Verpakkingen zonder kunststof Ja

[EU-richtlijn RoHS](#) Voldoet pro-actief (Product valt niet onder de EU RoHS juridische scope)

REACH-regelgeving [REACH-verklaring](#)

## Use Again

### Herverpakken en herfabriceren

Circulair Profiel [Informatie over einde levensduur](#)

Terugname No

WEEE Label  Het product moet op markten van de Europese Unie worden afgevoerd volgens specifieke afvalinzamelingsregels en mag nooit in een gewone vuilnisbak terechtkomen.

Dimensions Drawings

Dimensions

---

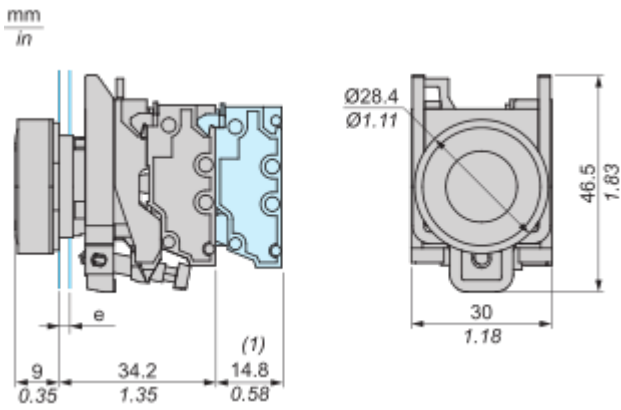

e : Clamping thickness: 1 to 6 mm / 0.04 to 0.24 in.

(1) : Additional row of contacts or double contact

Mounting and Clearance

Mounting

---

Mounting and Unmounting



Panel cut-out Dimension

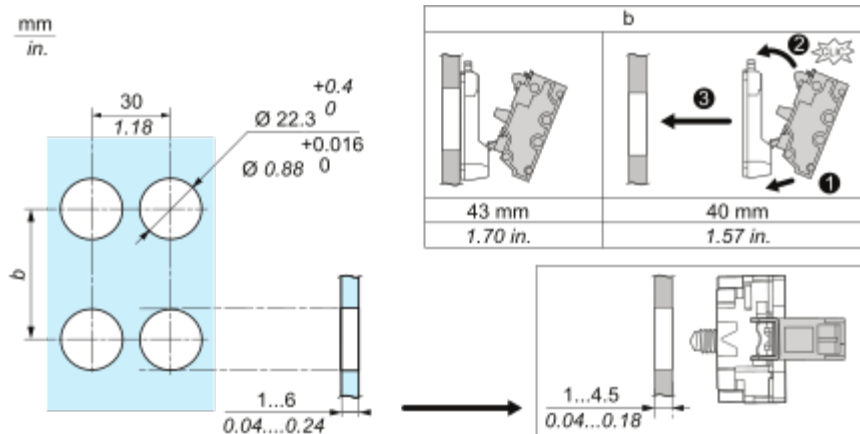

Connections and Schema

Wiring

Wiring and Unwiring

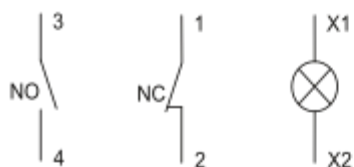

mm	8
in.	0.32
mm <sup>2</sup>	0.34...1.5
AWG	22...16

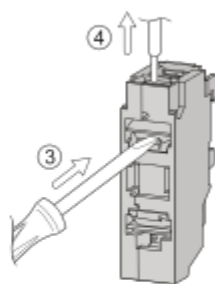
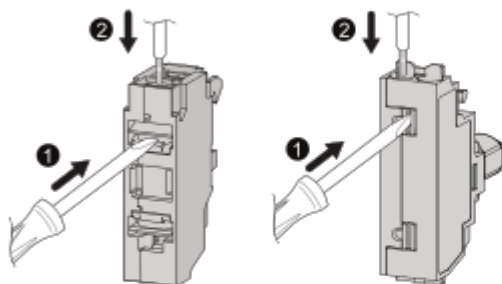
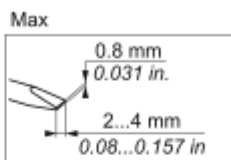

mm	8	8	8
in.	0.32	0.32	0.32
mm <sup>2</sup>	0.34...1.5	0.34...1	0.34...1.5
AWG	22...16	22...18	22...16

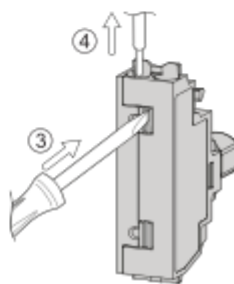
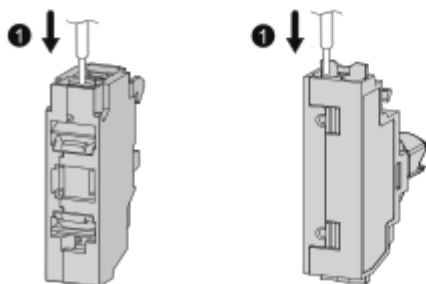

Technical Illustration

Dimensions

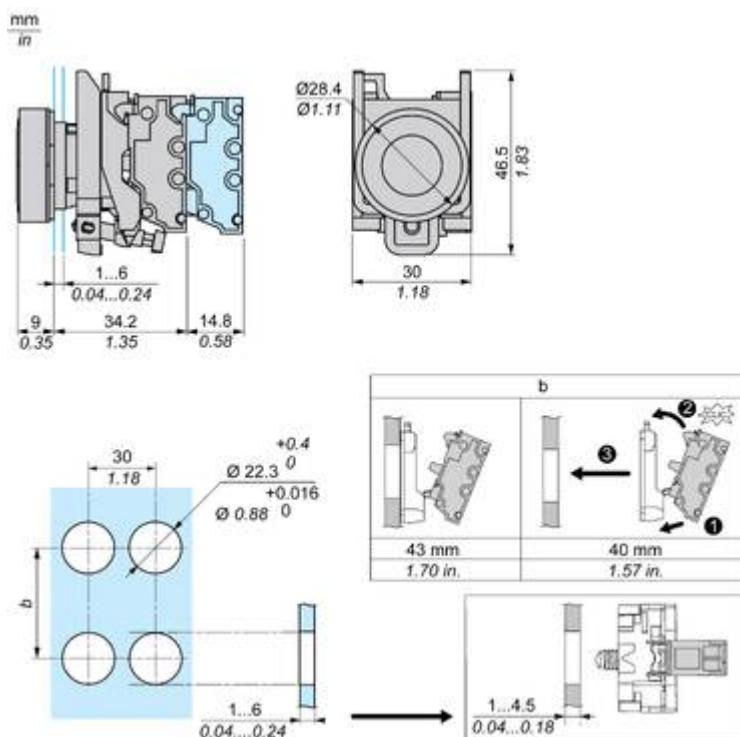

Technical Illustration

Wiring diagram

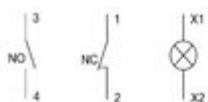

mm	8
in.	0.32
mm <sup>2</sup>	0.34...1.5
AWG	22...18

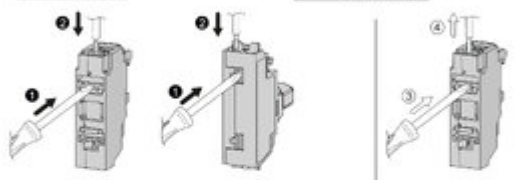
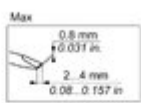

mm	8	8	8	Max
in.	0.32	0.32	0.32	1.9
mm <sup>2</sup>	0.34...1.5	0.34...1	0.34...1.5	0.09
AWG	22...18	22...18	22...18	0.09



Offer Marketing Illustration

Product benefits / Features

---

### Features Harmony XB4

- Quick and easy assembly and disassembly
- Excellent mechanical connection with operator head
- Various types of connection: screw clamp, connector, Faston connector, spring terminal, or printed circuit board
- Large set of accessories to customize your panels
- Robustness to withstand harsh environments

Offer Marketing Illustration

Product benefits / Features

---

## Technical Benefits

### Harmony XB4

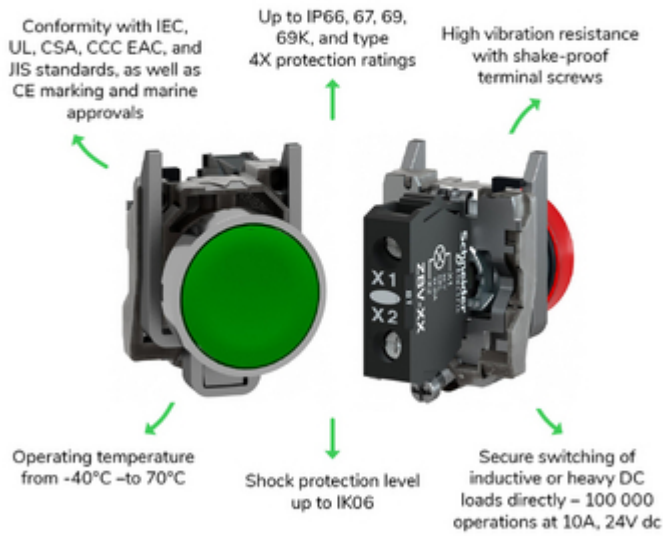

Image of product / Alternate images

Alternative

---

