

Productinformatieblad

Specificaties

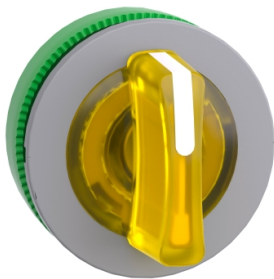

flush mounted XB5 yellow selector switch 3-position. cp grey

ZB5FK1583C0

Belangrijk bericht: A change in appearance may be noted on the product but does not affect its use in terms of function and safety. This makes it compatible with our Universal LED blocks
EAN Code: 3606489753894

Prijs: 31,85 EUR

Hoofd

range of product	Harmony XB5
product of component type	Kop voor verlichte keuzeschakelaar
compatibiliteit product	Universele LED
device short name	ZB5
kraag materiaal	Kunststof gekleurd grijs
bevestigingsdiameter	30,5 mm
koptype	Built-in-flush
verkoop per ondeelbare hoeveelheid	1
vorm van kop signaleringseenheid	Rond
type operator	Naar het midden terugverend
operator profiel	Geel standaard hendel
informatie positie operator	3 standen +/- 45°

Complementair

CAD totale breedte	37 mm
CAD totale hoogte	37 mm
CAD totale diepte	46 mm
gewicht product	0,03 kg
elektrische samenstellingscode	M3 voor <4 contacten gebruik enkelvoudig blokken in vooraan gemonteerd met integrale LED M6 voor <2 contacten gebruik enkelvoudig blokken in vooraan gemonteerd met ingebouwde LED en transformator M10 voor <2 contacten gebruik enkelvoudig blokken in vooraan gemonteerd met integrale LED MF1 voor <2 contacten gebruik enkelvoudig blokken in vooraan gemonteerd met integrale LED M4 voor <4 contacten gebruik enkelvoudig en dubbel blokken in vooraan gemonteerd met integrale LED

product presentatie	Basisonderdeel
---------------------	----------------

Omgeving

beschermende behandeling	TH
ambient air temperature for storage	-40...70 °C
omgevingstemperatuur voor werking	-40...70 °C

De weergegeven prijs is de adviesprijs in euro excl. BTW. Deze kan onderhevig zijn aan korting. Neem contact op met uw lokale distributeur of detailhandel voor de daadwerkelijke prijs

overvoltage category	Klasse II In overeenstemming met IEC 60536
IP beschermingsgraad	IP66 In overeenstemming met IEC 60529 IP67
Enclosure Type	UL type 4X/13
weerstand hoge druk drukring	7000000 Pa om 55 °C, afstand: 0.1 m
IK-beschermingsgraad	IK03 In overeenstemming met IEC 50102
standards	UL 508 EN/IEC 60947-5-4 JIS C8201-5-1 EN/IEC 60947-1 EN/IEC 60947-5-5 CSA C22.2 Nr 14 EN/IEC 60947-5-1 JIS C8201-1
product certifications	CSA DNV BV LROS (Lloyds register of shipping) UL listed
trilling bestendigheid	5 gn (f= 2...500 Hz) In overeenstemming met IEC 60068-2-6
schokbestendigheid	30 gn (duur = 18 ms) voor halve sinusgolf versnelling In overeenstemming met IEC 60068-2-27 50 gn (duur = 11 ms) voor halve sinusgolf versnelling In overeenstemming met IEC 60068-2-27

Verpakkingseenheid

Eenheidstype van verpakking 1	PCE
Aantal eenheden in verpakking 1	1
verpakking 1 hoogte	5,45 cm
verpakking 1 breedte	4,3 cm
verpakking 1 lengte	5,2 cm
verpakking_1_gewicht	22,0 g

contractuele waarborg

Garantie (in maanden)	18
------------------------------	----



Environmental Data

Schneider Electric wil tegen 2050 de Net Zero-status hebben bereikt via partnerschappen in de toeleveringsketen, materialen met een lagere impact en circulariteit via onze doorlopende campagne "Use Better, Use Longer, Use Again" om de levensduur van producten en de recycleerbaarheid te verlengen.

[Uitleg van Environmental Data >](#)

[Hoe evalueren we de duurzaamheid van producten? >](#)



Milieuvoetafdruk

Milieu Profiel

[Milieuprofiel van het product](#)

Use Better



Materialen en verpakking

Pakket met gerecycleerd karton

Nee

Verpakkingen zonder kunststof

Nee

RoHS-richtlijn van de EU

[Conform](#)

REACH-verordening

[Referentie bevat geen SVHC boven drempelwaarde](#)

Use Longer



Levensduurverlenging

Reparatie

Nee

Use Again



Herverpakken en herfabriceren

Circulair Profiel

[Informatie over einde levensduur](#)

Terugname

Ja

Dimensions Drawings

Dimensions

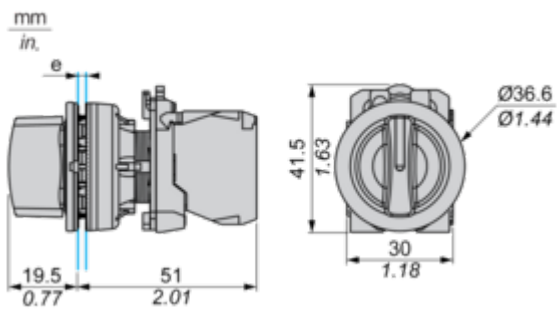

e: Clamping thickness: 1 to 6 mm / 0.04 to 0.24 in.

Mounting and Clearance

Panel Cut-out for Pushbuttons, Switches and Pilot Lights (Finished Holes, Ready for Installation)

Connection by Screw Clamp Terminals or Plug-in Connectors

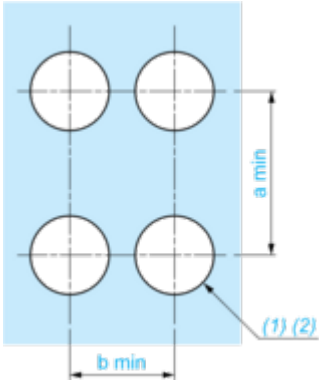

(1) Diameter on finished panel or support

(2) $\varnothing 30.75$ mm recommended ($\varnothing 30.5 \begin{smallmatrix} +0.5 \\ 0 \end{smallmatrix}$) / $\varnothing 1.21$ in. recommended ($\varnothing 1.20$ in. $\begin{smallmatrix} +0.0196 \\ 0 \end{smallmatrix}$)

Connections	a in mm	a in in.	b in mm	b in in.
By screw clamp terminals or plug-in connector	40	1.57	40	1.57
By Faston connectors	45	1.77	40	1.57

Technical Description

Electrical Composition Corresponding to Code M3

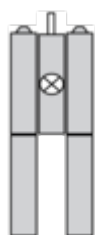

Electrical Composition Corresponding to Code M4

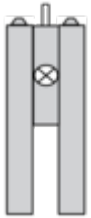

Electrical Composition Corresponding to Codes M6 and P2



Electrical Composition Corresponding to Codes M5, M10, MF1, MR1 and MF2

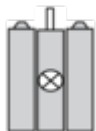

Legend

Single contact



Double contact



Light block



Possible location



Sequence of Contacts Fitted to 2-position Selector Switch Body

Position 315°



Push	Position	Top			
		Bottom			
	Location		Left		Right
	State		0		0
	Contacts	N/O			open
N/C		closed	closed		

Position 45°



Push	Position	Top			
		Bottom			
	Location		Left		Right
	State		1		1
Contacts	N/O		closed	closed	
	N/C		open	open	

Technical Illustration

Dimensions

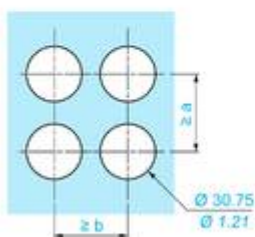
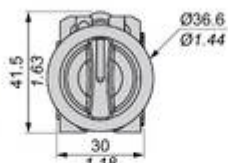
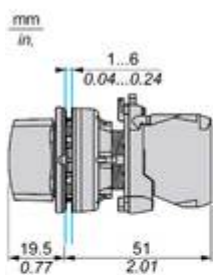







		a (mm)	a (in.)	b (mm)	b (in.)
		40	1.57	40	1.57
ZBE.....	ZBV.....				
		45	1.77	40	1.57
ZBE.....3	ZBV.....3				
		40	1.57	40	1.57
ZBE.....4	ZBV.....4				

Image of product / Alternate images

Alternative



