

Productinformatieblad

Specificaties



Harmony XB4, Dubbele verlichte drukknop, Groen verz./rood verhoogd, Ø22mm

ZB4BW7L3741

EAN Code: 3389119043779

Prijs: 23,55 EUR

Hoofd

range of product	Harmony XB4
product or component type	Kop voor verlichte drukknop met dubbele kop
compatibiliteit product	Integrale LED
device short name	ZB4
kraag materiaal	Verchroomd metaal
koptype	Standaard
bevestigingsdiameter	22 mm
verkoop per ondeelbare hoeveelheid	1
vorm van kop signaleringseenheid	Rechthoekig
type operator	terugverend
operator profiel	1 standaard knop - 1 verhoogde knop - 1 signaallamp
operatorbeschrijving	Groen 'I' - rood 'O'

Complementair

CAD totale breedte	30 mm
CAD totale hoogte	50 mm
CAD totale diepte	30 mm
net weight	0,056 kg
weerstand hoge druk drukkring	7000000 Pa bij 55 °C, afstand: 0.1 m
kleur van markering	Witte markering bij groene, rode of zwarte schildjes Zwarte markering bij witte schildjes
operator profiel	Groen verzonken, I (wit) Rood uitspringend, O (wit)
mechanical durability	1000000 cycles
elektrische samenstellingscode	M1 voor <6 contacten met enkelvoudig blokken in vooraan gemonteerd met integrale LED M2 voor <6 contacten met enkelvoudig en dubbel blokken in vooraan gemonteerd met integrale LED M6 voor <2 contacten met enkelvoudig blokken in vooraan gemonteerd met ingebouwde LED en transformator M10 voor <2 contacten met enkelvoudig blokken in vooraan gemonteerd met integrale LED
product presentatie	Basis sub-eenheden

Omgeving

De weergegeven prijs is de adviesprijs in euro excl. BTW. Deze kan onderhevig zijn aan korting. Neem contact op met uw lokale distributeur of detailhandel voor de daadwerkelijke prijs

beschermende behandeling	TH
ambient air temperature for storage	-40...70 °C
ambient air temperature for operation	-40...70 °C
beschermingsklasse tegen elektrische schokken	Klasse I conforming to IEC 61140
IP beschermingsgraad	IP66 conform aan IEC 60529 IP69K IP69 conform aan IEC 60529
NEMA beschermingsgraad	NEMA 13 NEMA 4X
IK-beschermingsgraad	IK06 conforming to IEC 50102
standards	IEC 60947-5-5 UL 508 CSA C22.2 Nr 14 IEC 60947-5-4 JIS C8201-5-1 IEC 60947-5-1 IEC 60947-1 JIS C8201-1
product certifications	CSA LROS (Lloyds register of shipping) BV UL listed DNV
trilling bestendigheid	5 gn (f= 2...500 Hz) conforming to IEC 60068-2-6
schokbestendigheid	30 gn (duur = 18 ms) voor halve sinusgolf versnelling conform aan IEC 60068-2-27 50 gn (duur = 11 ms) voor halve sinusgolf versnelling conform aan IEC 60068-2-27

Verpakkingseenheid

Unit Type of Package 1	PCE
Number of Units in Package 1	1
Package 1 Height	5,500 cm
Package 1 Width	3,300 cm
Package 1 Length	5,300 cm
Package 1 Weight	58,000 g
Unit Type of Package 2	S03
Number of Units in Package 2	200
Package 2 Height	30,000 cm
Package 2 Width	30,000 cm
Package 2 Length	40,000 cm
Package 2 Weight	12,006 kg

contractuele waarborg

Garantie	18 months
----------	-----------

Environmental Data

Schneider Electric wil tegen 2050 de Net Zero-status hebben bereikt via partnerschappen in de toeleveringsketen, materialen met een lagere impact en circulariteit via onze doorlopende campagne "Use Better, Use Longer, Use Again" om de levensduur van producten en de recycleerbaarheid te verlengen.

[Uitleg van Environmental Data](#) >

[Hoe evalueren we de duurzaamheid van producten?](#) >

Milieuoetafdruk

Totale levenscyclus ecologische voetafdruk 1

Milieuprofiel van product (PEP) [Milieuprofiel van het product](#)

Use Better

Materialen en verpakking

Pakket met gerecycleerd karton Ja

Verpakkingen zonder kunststof Ja

[EU-richtlijn RoHS](#)

Voldoet pro-actief (Product valt niet onder de EU RoHS juridische scope)

REACH-regelgeving

[REACH-verklaring](#)

Use Again

Herverpakken en herfabriceren

Circulair Profiel [Informatie over einde levensduur](#)

Terugname No

Dimensions Drawings

Dimensions

Without Boot

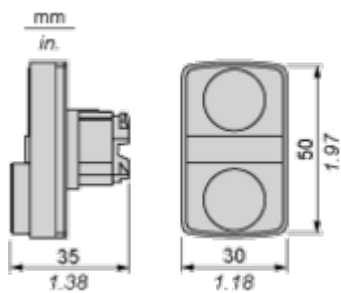

With Boot ZBA710

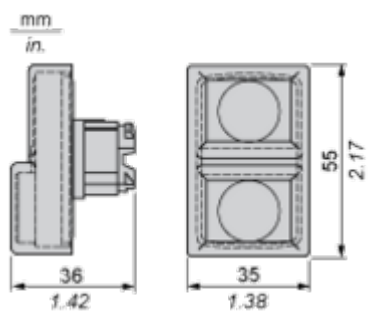

Mounting and Clearance

Panel Cut-out for Pushbuttons, Switches and Pilot Lights (Finished Holes, Ready for Installation)

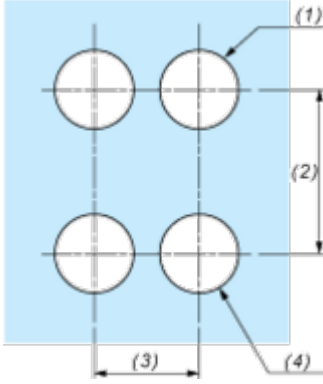
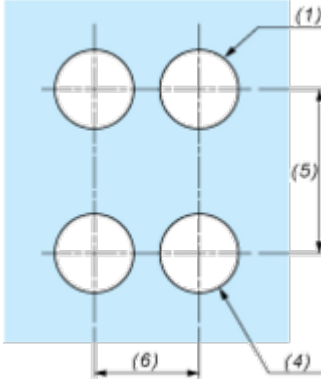
Connection by Screw Clamp Terminals or Plug-in Connectors or on Printed Circuit Board	Connection by Faston Connectors
	
<p>(1) Diameter on finished panel or support (2) 40 mm min. / 1.57 in. min. (3) 30 mm min. / 1.18 in. min. (4) $\varnothing 22.5 \text{ mm} / 0.89 \text{ in.}$ recommended ($\varnothing 22.3 \text{ mm} \begin{smallmatrix} +0.4 \\ 0 \end{smallmatrix} / 0.88 \text{ in.} \begin{smallmatrix} +0.016 \\ 0 \end{smallmatrix}$) (5) 45 mm min. / 1.78 in. min. (6) 32 mm min. / 1.26 in. min.</p>	



A: 1.18 in. min.

B: 1.57 in. min.

General Tolerances of the Panel and Printed Circuit Board

The cumulative tolerance must not exceed 0.3 mm / 0.012 in: $T1 + T2 = 0.3 \text{ mm max.}$

Installation Precautions

- Minimum thickness of circuit board: 1.6 mm / 0.06 in.
- Cut-out diameter: 22.4 mm \pm 0.1 / 0.88 in. \pm 0.004
- Orientation of body/fixing collar ZB4 BZ009: $\pm 2^\circ 30'$ (excluding cut-outs marked a and b).
- Tightening torque of screws ZBZ 006: 0.6 N.m (5.3 lbf.in) max.
- Allow for one ZB4 BZ079 fixing collar/pillar and its fixing screws:
 - every 90 mm / 3.54 in. horizontally (X), and 120 mm / 4.72 in. vertically (Y).
 - with each selector switch head (ZB4 BD*, ZB4 BJ*, ZB4 BG*).

The fixing centers marked a and b are diagonally opposed and must align with those marked 4 and 5.

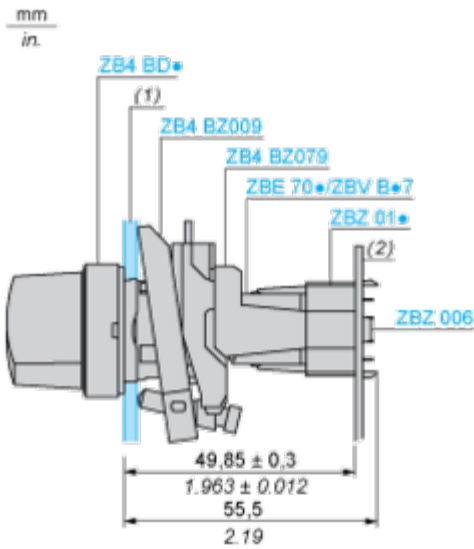

(1) Panel

(2) Printed circuit board

Mounting of Adapter (Socket) ZBZ 01•

- 1 2 elongated holes for ZBZ 006 screw access
- 2 1 hole $\varnothing 2.4 \text{ mm} \pm 0.05 / 0.09 \text{ in.} \pm 0.002$ for centring adapter ZBZ 01•
- 3 $8 \times \varnothing 1.2 \text{ mm} / 0.05 \text{ in.}$ holes
- 4 1 hole $\varnothing 2.9 \text{ mm} \pm 0.05 / 0.11 \text{ in.} \pm 0.002$, for aligning the printed circuit board (with cut-out marked a)
- 5 1 elongated hole for aligning the printed circuit board (with cut-out marked b)
- 6 4 holes $\varnothing 2.4 \text{ mm} / 0.09 \text{ in.}$ for clipping in adapter ZBZ 01•

Dimensions An + 18.1 relate to the $\varnothing 2.4 \text{ mm} \pm 0.05 / 0.09 \text{ in.} \pm 0.002$ holes for centring adapter ZBZ 01•.

Technical Description

Electrical Composition Corresponding to Codes M1 and M7

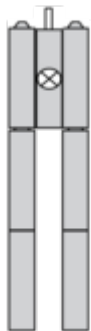

Electrical Composition Corresponding to Codes M2 and M8

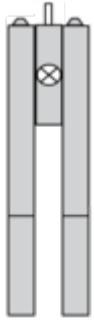

Electrical Composition Corresponding to Codes M6 and P2

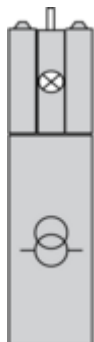

Electrical Composition Corresponding to Codes M5, M10, MF1, MR1 and MF2

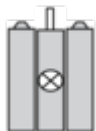

Legend

Single contact



Double contact



Light block



Possible location



Technical Illustration

Dimensions

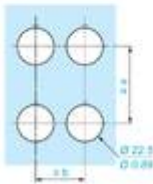
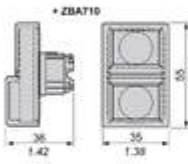
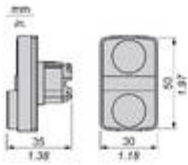

		a (mm)	a (in.)	b (mm)	b (in.)
		40	1.57	30	1.18
ZB1*****	ZB1*****				
		45	1.77	32	1.26
ZB1*****5	ZB1*****3				
		40	1.57	30	1.18
ZB1*****4	ZB1*****4				
		50	1.97	30	1.18
ZB1*****5	ZB1*****5				
		40	1.57	30	1.18
ZB1*****9	ZB1*****9				
ZBRT*	ZBRV1	40	1.57	30	1.18

Offer Marketing Illustration

Product benefits / Features

Features
Harmony XB4/XB5 Illuminated functions

NEW universal LED Block for all colors

Simple stock management

Improved installation time and easy selection

Improved color intensity and brightness

The image features a green background with the title 'Features' and subtitle 'Harmony XB4/XB5 Illuminated functions'. It displays four key benefits, each with a circular icon and a corresponding photograph of the product. The benefits are: 1. 'NEW universal LED Block for all colors' with a square icon containing a smaller square. 2. 'Simple stock management' with an icon of a person holding a clipboard. 3. 'Improved installation time and easy selection' with a circular arrow icon. 4. 'Improved color intensity and brightness' with a sun icon. The product images show various colored buttons (green, red, yellow) and their internal LED components.



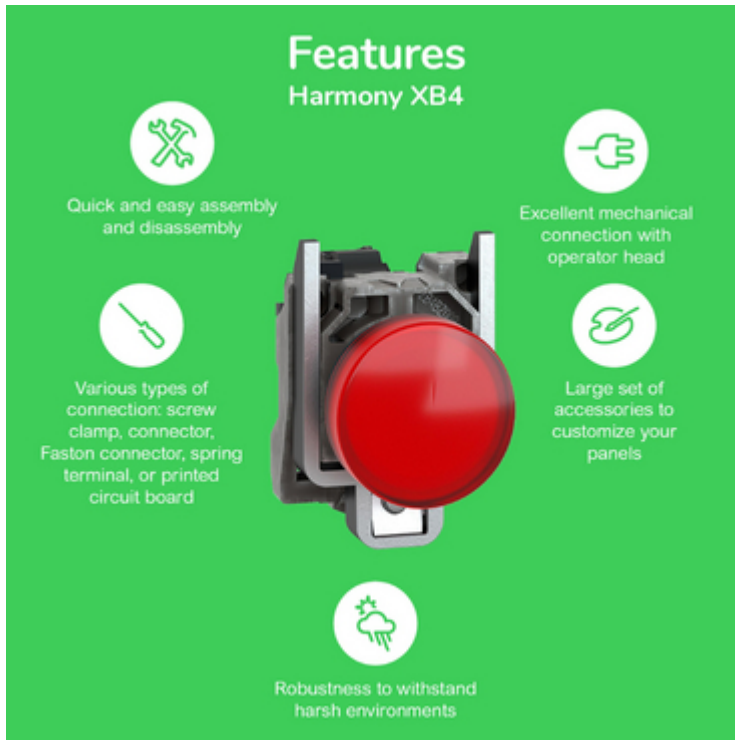

Offer Marketing Illustration

Product benefits / Features



The infographic features a central image of a red Schneider XB4 circuit breaker. It is surrounded by five circular icons, each with a corresponding text description of a feature. The background is a solid green color.

Features Harmony XB4

-  Quick and easy assembly and disassembly
-  Various types of connection: screw clamp, connector, Faston connector, spring terminal, or printed circuit board
-  Excellent mechanical connection with operator head
-  Large set of accessories to customize your panels
-  Robustness to withstand harsh environments

Offer Marketing Illustration

Product benefits / Features

Technical Benefits

Harmony XB4

Conformity with IEC, UL, CSA, CCC EAC, and JIS standards, as well as CE marking and marine approvals

Up to IP66, 67, 69, 69K, and type 4X protection ratings

High vibration resistance with shake-proof terminal screws

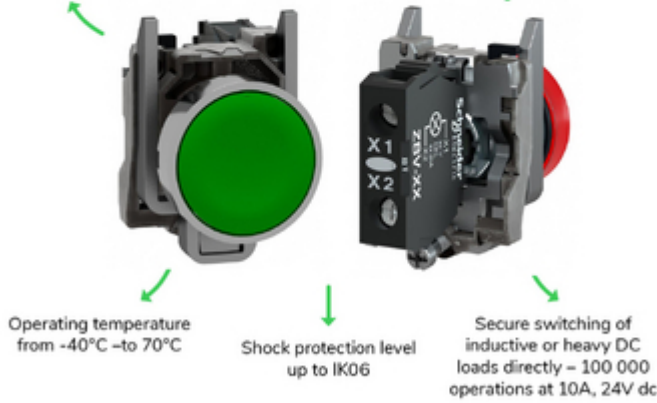

Operating temperature from -40°C to 70°C

Shock protection level up to IK06

Secure switching of inductive or heavy DC loads directly – 100 000 operations at 10A, 24V dc

Image of product / Alternate images

Alternative



