







36 211 705

- Drehumstellung
- Rosette 60 x 60 mm

Passt zu CL.1



	Champagne gebürstet (22kt Gold)	36 211 705-46
	Chrom	36 211 705-00
	Platin gebürstet	36 211 705-06
	Dark Chrome	36 211 705-19
	Champagne (22kt Gold)	36 211 705-47
	Dark Platinum gebürstet	36 211 705-99

36 211 705

mm [inches]

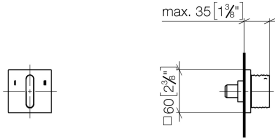

Durchflussdiagramm



Codes & Standards

DIN 4109

ISO 3822

Scottish Water
Byelaws

UK Water Supply
Regulations

Ü-Zeichen



CL.1 UP-Dreiwege-Umstellung - Champagne gebürstet (22kt Gold)

CL.1

36 211 705

Zertifikate

WRAS_2307

LGA_38

36 211 705

Produktversion ab 4/1/2022

Ersatzteile für die
anderen
Oberflächenvarianten
finden Sie hier:
Chrom

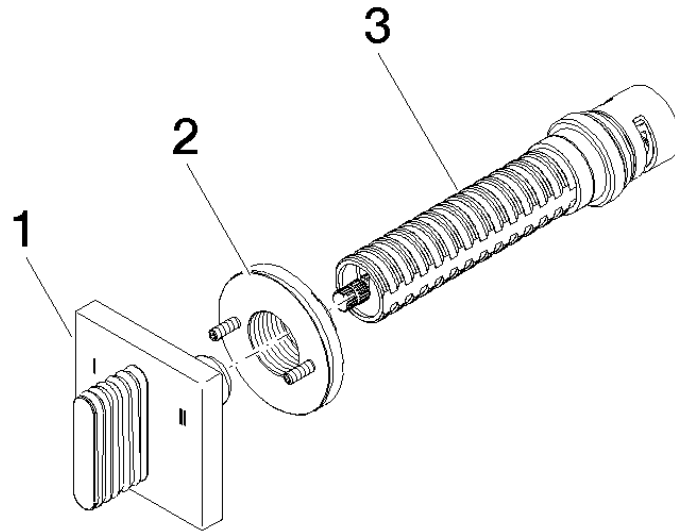



CL.1 UP-Dreiwege-Umstellung - Champagne gebürstet (22kt Gold)

CL.1

36 211 705

Ersatzteilstückliste

Produktversion ab 4/1/2022

Nr.	Artikelnummer	Benennung	Verbaumenge	Lieferzeit
	90 20 70 055 10-46	Griff - Champagne gebürstet (22kt Gold)	3	30