

Data Sheet | Item Number: 2092-1603

Gripping plate; for female and male connectors; 1 part; Pin spacing 5 mm; light gray

<https://www.wago.com/2092-1603>

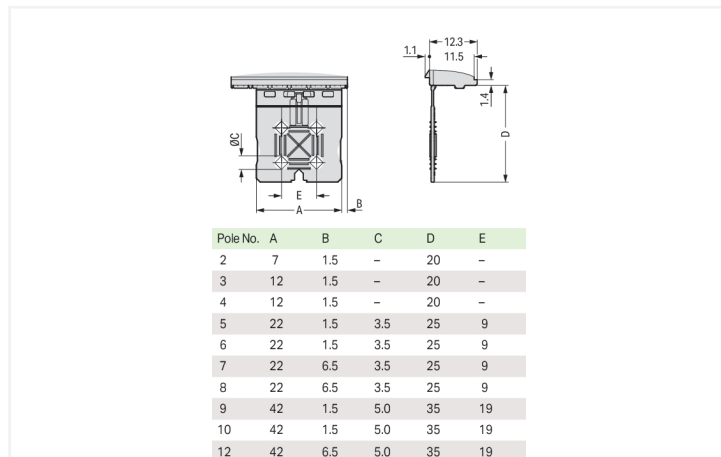

Color: ■ light gray

Similar to illustration

Dimensions in mm

Physical data

Pin spacing	5 mm / 0.197 inches
Width	42 mm

Material data

Note (material data)	Information on material specifications can be found here
Color	light gray
Fire load	0.04 MJ
Weight	1.3 g

Commercial data

Product Group	26 (picoMAX Connectors)
PU (SPU)	100 (25) pcs
Packaging type	Box
Country of origin	DE
GTIN	4050821164333
Customs tariff number	85389099990

Product Classification

UNSPSC	39121409
eCl@ss 10.0	27-14-11-92
eCl@ss 9.0	27-14-11-92
ETIM 9.0	EC002848
ETIM 10.0	EC002848
ECCN	NO US CLASSIFICATION

Environmental Product Compliance

RoHS Compliance Status

Compliant, No Exemption

Downloads

Environmental Product Compliance

Compliance Search

Environmental Product
Compliance 2092-1603



Documentation

Additional Information

Technical Section

03.04.2019

pdf

2027.26 KB



Installation Notes

Strain relief

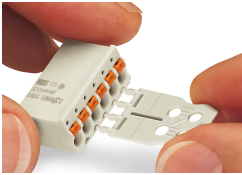

Gripping plates are suitable for factory and field assembly.