

# Surge Protection SPBT12



*Powering Business Worldwide*

sg03316



## Description

- Combined test class 1/2 tested SPD
- Suitable for applications with an external lightning protection system (where also a limp of 12,5 kA per phase is needed)
- For TT, TN-C and TN-S supply systems
- Auxiliary contact and busbar available as an accessory

## Types

### SPB „BB“

- SPD which can be connected via busbar to a 4pole protective device/switch disconnecter

### SPB „NPE“

- Galvanic separated SPD path between neutral and protective earth
- Suitable for TT and TN-S systems due to the 3+1 connection

Description	Type Designation	Article No.	Units per package
-------------	---------------------	-------------	----------------------

### Lightning current arrester - surge arrester sets, Lightning protection classes III, IV

sg28912



#### Single phase supply / 2+0 connection

TN-S-Set 2pole	SPBT12-280/2	158309	1 / 60
----------------	--------------	--------	--------

sg03216



#### Single phase supply / 1+1 connection

TN-S/TT Set 1+N Set 50kA	SPBT12-280-1+NPE50	184752	1 / 30
TN-S/TT-Set 1+1pole 100kA	SPBT12-280-1+NPE	158308	1 / 40

sg29612



#### Three phase supply

TN-C-Set 3pole (3+0 connection)	SPBT12-280/3	158330	1 / 40
TN-S-Set 4pole (4+0 connection)	SPBT12-280/4	158331	1 / 30

sg03316



#### Three phase supply / 3+1 connection (50 kA)

TN-S/TT Set 3+N Set	SPBT12-280-3+NPE50	184750	1 / 80
TN-S/TT Set 3+N Set with busbar	SPBT12-280-3+NPE50/BB	184751	1

sg65112



#### Three phase supply / 3+1 connection (100 kA)

TN-S/TT-Set 3+1pole	SPBT12-280-3+NPE	158332	1 / 20
TN-S/TT-Set 3+1pole with busbar	SPBT12-280-3+NPE/BB	158333	1

Description	Type Designation	Article No.	Units per package
-------------	------------------	-------------	-------------------

**Accessories**

Auxiliary switch for SPBT12-280	ASAUWSC-SPM	131785	4/120
Busbar	ZV-KSBL...		

Impulse current $I_{imp}$ (10/350) $\mu$ s	Type Designation	Article No.	Units per package
-----------------------------------------------	------------------	-------------	-------------------

**Lightning current arrester - surge arrester SPBT12**

**Complete**

12.5 kA L - (PE) N	SPBT12-280/1	158306	12/120
50 kA N-PE	SPBT12-NPE50	184749	1/60
100 kA N-PE	SPBT12-NPE100	158307	1/60

**Insert**

12.5 kA Insert	SPBT12-280	167341	2/120
----------------	------------	--------	-------

sg63312



### Description Surge Protective Class T1&T2

- Field of application:  
For the protection of low voltage distribution systems against transient overvoltage caused by direct and indirect lightning stroke and switching operations
- Application according to IEC 60364-5-53 Clause 534
- Test class **I**, **II** according to IEC 61643-11
- SPD-type **T1**, **T2** according to EN 61643-11
- Lightning protection classes III and IV according to IEC 62305
- Busbars ZV-KSBI are available for all customary applications

### Technical Data

		SPBT12-280...	SPBT12-NPE50	SPBT12-NPE100
<b>Electrical</b>	per pole			
Responding time (rate of voltage rise 5 kV/μs)		< 25 ns	< 100 ns	< 100 ns
Voltage protection level	$U_p$	≤ 1.5 kV	< 1.4 kV	< 1.5 kV
Voltage protection level at 5 kA (8/20) μs	$U_p$	950 V	–	–
Max. continuous operating voltage	$U_c$	280 VAC	260 VAC	255 VAC
TOV test value	$U_T$	335 VAC (5 s)	1200 VAC (200 ms)	1200 VAC (200 ms)
Rated frequency		50 Hz	50 Hz	50 Hz
Open circuit voltage	$U_{oc}$	10 kV	–	20 kV
Nominal discharge current (8/20) μs	$I_n$	25 kA	50 kA	100 kA
Max. discharge current	$I_{max}$	50 kA	100 kA	100 kA
Impulse current (10/350) μs	$I_{imp}$			
Peak current		12.5 kA	50 kA	100 kA
Follow current interrupt rating	$I_{fi}$	–	100 A <sub>r.m.s.</sub>	100 A <sub>r.m.s.</sub>
Maximum back-up fuse		160 AgL/gG	–	–
Maximum short-circuit current		50 kA <sub>r.m.s.</sub>	–	–

Connection diagram

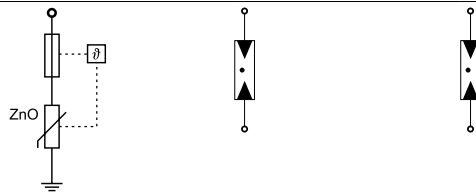

### Mechanical

Frame size		45 mm	45 mm	45 mm
Device height		80 mm	80 mm	80 mm
Device width		17.5 mm	17.5 mm	35 mm
Weight		121 g	93 g	250 g
Permitted ambient temperature		-40°C to +70°C	-40°C to +70°C	-40°C to +70°C
Degree of protection		IP20	IP20	IP20
Upper and lower lift terminal capacity		4 - 25 mm <sup>2</sup>	top 4 - 50 mm <sup>2</sup> , bottom 4 - 35 mm <sup>2</sup>	4 - 35 mm <sup>2</sup>
Upper and lower open mouthed terminals for busbar thickness up to		1.5 mm	top - / bottom 1.5 mm	1.5 mm
Tightening torque of terminal screws		2.4 - 3 Nm	2.4 - 3 Nm	2.4 - 3 Nm
Quick fastening on DIN rail according to		IEC/EN 60715	IEC/EN 60715	IEC/EN 60715
Accessories: busbars 16 mm <sup>2</sup>		Type ZV-KSBI ...	Type ZV-KSBI ...	Type ZV-KSBI ...

### Dimensions (mm)

SPBT12-280 SPBT12-NPE100  
SPBT12-NPE50

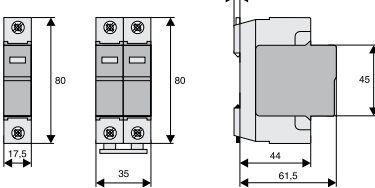

### Lightning current arrester - surge arrester sets, Lightning protection classes III, IV

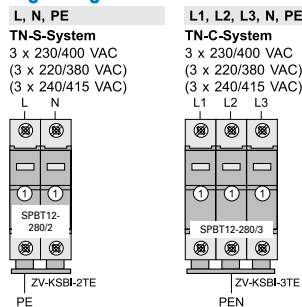

① ... SPBT12-280

Technical Data

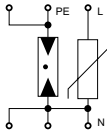
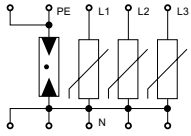
		SPBT12-280-1+NPE50	SPBT12-280-3+NPE50
<b>Electrical</b>			
		per pole	
Responding time (rate of voltage rise 5 kV/μs)	L-N / N-PE	< 25 ns / < 100 ns	< 25 ns / < 100 ns
Voltage protection level	L-N / L-PE / N-PE	$U_p$ < 1.5 kV	< 1.5 kV
Max. continuous operating voltage	L-N / N-PE	$U_c$ 280 VAC / 260 VAC	280 VAC / 260 VAC
TOV test value		$U_T$	
5 s	L-N / L-PE	348 VAC / 370 VAC	348 VAC / 370 VAC
200 ms	N-PE	1200 VAC	1200 VAC
Rated frequency		50/60 Hz	50/60 Hz
Open circuit voltage		$U_{oc}$ 10 kV	20 kV
Nominal discharge current (8/20) μs	L-N / N-PE	$I_n$ 25 kA / 50 kA	3x25 kA / 50 kA
Max. discharge current	L-N / N-PE	$I_{max}$ 50 kA / 100 kA	3x50 kA / 100 kA
Impulse current (10/350) μs		$I_{imp}$	
Peak current	L-N / N-PE	12.5 kA / 50 kA	3x12.5 kA / 50 kA
Follow current interrupt rating	N-PE	$I_{fi}$ 100 $A_{r.m.s.}$	100 $A_{r.m.s.}$
Maximum back-up fuse		—	—
Maximum short-circuit current		—	—
Connection diagram			

Mechanical

Frame size	45 mm	45 mm
Device height	80 mm	80 mm
Device width	35 mm	70 mm
Weight	218 g	470 g
Permitted ambient temperature	-40°C to +70°C	-40°C to +70°C
Degree of protection (built-in)	IP40	IP40
Upper and lower lift terminal capacity		
L, N	4 - 25 mm <sup>2</sup>	4 - 25 mm <sup>2</sup>
N, PE	4 - 50 mm <sup>2</sup>	4 - 50 mm <sup>2</sup>
Upper and lower open mouthed terminals for busbar thickness up to	1.5 mm	1.5 mm
Tightening torque of terminal screws	2.4 - 3 Nm	2.4 - 3 Nm
Quick fastening on DIN rail according to	IEC/EN 60715	IEC/EN 60715
Accessories: busbars 16 mm <sup>2</sup>	Type ZV-KSBI ...	Type ZV-KSBI ...

Lightning current arrester - surge arrester sets, Lightning protection classes III, IV

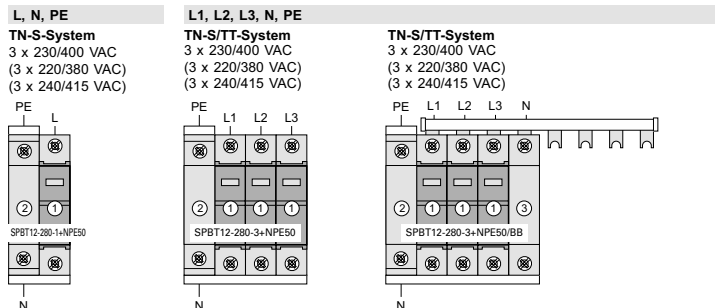

- ① ... SPBT12-280
- ② ... SPBT12-NPE50
- ③ ... ASLTT-63

### Technical Data

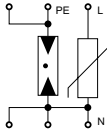
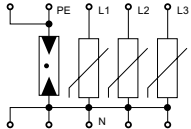
		<b>SPBT12-280-1+NPE</b>	<b>SPBT12-280-3+NPE</b>
<b>Electrical</b>	per pole		
Responding time (rate of voltage rise 5 kV/μs)	L-N / N-PE	< 25 ns / < 100 ns	< 25 ns / < 100 ns
Voltage protection level	L-N / L-PE / N-PE	$U_p$ < 1.5 kV	< 1.5 kV
Max. continuous operating voltage	L-N / N-PE	$U_c$ 280 VAC / 255 VAC	280 VAC / 255 VAC
TOV test value		$U_T$	
5 s	L-N / L-PE	348 VAC / 370 VAC	348 VAC / 370 VAC
200 ms	N-PE	1200 VAC	1200 VAC
Rated frequency		50 Hz	50 Hz
Open circuit voltage		$U_{oc}$ 10 kV	20 kV
Nominal discharge current (8/20) μs	L-N / N-PE	$I_n$ 25 kA / 100 kA	3x25 kA / 100 kA
Max. discharge current	L-N / N-PE	$I_{max}$ 50 kA / 100 kA	3x50 kA / 100 kA
Impulse current (10/350) μs		$I_{imp}$	
Peak current	L-N / N-PE	12.5 kA / 100 kA	3x12.5 kA / 100 kA
Follow current interrupt rating	N-PE	100 $A_{r.m.s.}$	100 $A_{r.m.s.}$
Maximum back-up fuse		160 AgL/gG	160 AgL/gG
Maximum short-circuit current		50 $kA_{r.m.s.}$	50 $kA_{r.m.s.}$
Connection diagram			
<b>Mechanical</b>			
Frame size		45 mm	45 mm
Device height		80 mm	80 mm
Device width		52.5 mm	87.5 mm
Weight		375 g	626 g
Permitted ambient temperature		-40°C to +70°C	-40°C to +70°C
Degree of protection (built-in)		IP40	IP40
Upper and lower lift terminal capacity			
L, N		4 - 25 mm <sup>2</sup>	4 - 25 mm <sup>2</sup>
N, PE		4 - 35 mm <sup>2</sup>	4 - 35 mm <sup>2</sup>
Upper and lower open mouthed terminals for busbar thickness up to		1.5 mm	1.5 mm
Tightening torque of terminal screws		2.4 - 3 Nm	2.4 - 3 Nm
Quick fastening on DIN rail according to		IEC/EN 60715	IEC/EN 60715
Accessories: busbars 16 mm <sup>2</sup>		Type ZV-KSBI ...	Type ZV-KSBI ...

### Lightning current arrester - surge arrester sets, Lightning protection classes III, IV

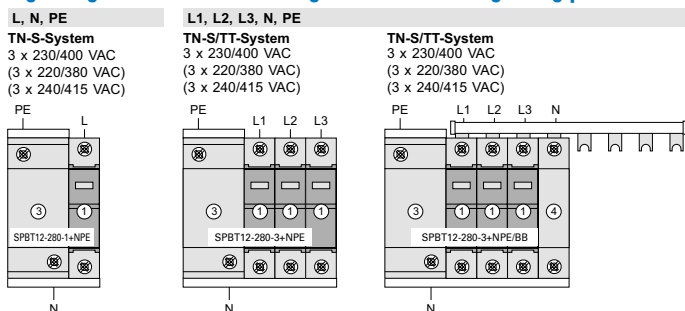







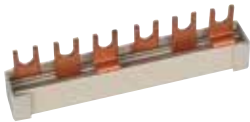







- ① ... SPBT12-280
- ② ... ASAXSC-SPM
- ③ ... SPBT12-NPE100
- ④ ... ASLTT-63

Used for	Type Designation	Article No.	Units per package
<b>Busbar Z-GV-16/3P-3TE/6</b>			
for SPBT12 & SPCT2	Z-GV-16/3P-3TE/6	267511	12/240

WA\_SG11202





	Poles	Type Designation	Article No.	Units per package
<b>Busbar ZV-KSBI for SPBT12 &amp; SPCT2</b>				
 ZV-KSBI-2TE	2MU	ZV-KSBI-2MU	263961	10/600
 ZV-KSBI-3TE	3MU	ZV-KSBI-3TE	263962	10/600
 ZV-KSBI-3TE/S	3MU	ZV-KSBI-3TE/S	263963	10/600
 ZV-KSBI-3TE+HI	2MU+1.5MU	ZV-KSBI-3TE+HI	112370	50/150
 ZV-KSBI-4TE	4MU	ZV-KSBI-4TE	263964	10/600
 ZV-KSBI-5TE	5MU	ZV-KSBI-5TE	263965	10/200
 ZV-KSBI-5TE/N	5MU	ZV-KSBI-5TE/N	263966	10/200
 ZV-KSBI-5TE+HI	2MU+3x1.5MU	ZV-KSBI-5TE+HI	112371	50/150
 ZV-KSBI-6TE	6MU	ZV-KSBI-6TE	113118	50/500
 ZV-KSBI-7TE	7MU	ZV-KSBI-7TE	263967	50/500
 ZV-KSBI-7TE/S	7MU	ZV-KSBI-7TE/S	263968	10/100
 ZV-KSBI-7TE/N	7MU	ZV-KSBI-7TE/N	263969	10/100
 ZV-KSBI-9TE/N	9MU	ZV-KSBI-9TE/N	266874	50/500
 ZV-KSBI-11TE	11MU	ZV-KSBI-11MU	263970	50/500

### Description busbar ZV-KSBI

- With the ZV KSBI busbar bracket you can realize the common combinations of arrestors.
- Used for SPB-..., SPC-..., Z-D63
- The rated cross-section of the ZV-KSBI bridge metals is 16 mm<sup>2</sup>
- The busbar mounting bracket can be shortened

### Technical Data

ZV-KSBI	
<b>Electrical</b>	
Rated voltage	230/400 V, 50/60 Hz
Rated current	63 A
<b>Mechanical</b>	
Busbar cross section	16 mm <sup>2</sup> Cu

### Design

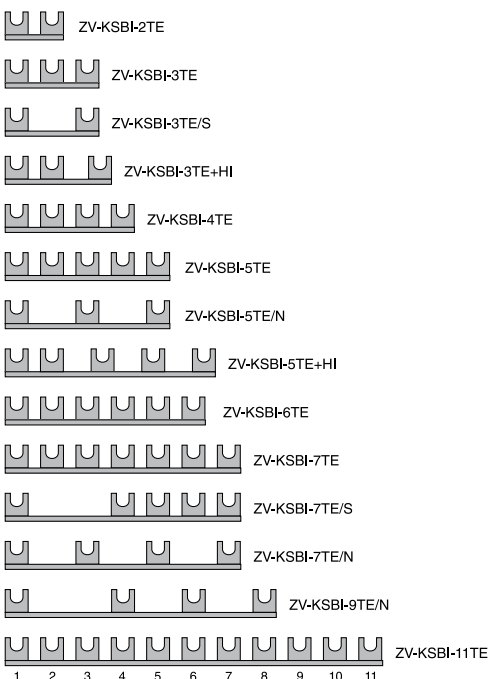

Eaton's electrical business is a global leader with deep regional application expertise in power distribution and circuit protection; power quality, backup power and energy storage; control and automation; life safety and security; structural solutions; and harsh and hazardous environment solutions. Through end-to-end services, channel and an integrated digital platform & insights Eaton is powering what matters across industries and around the world, helping customers solve their most critical electrical power management challenges.

For more information, visit [Eaton.com](https://www.eaton.com).



**Eaton Industries (Austria) GmbH**  
Scheydgasse 42  
1210 Vienna  
Austria

**Eaton**  
EMEA Headquarters  
Route de la Longeraie 7  
1110 Morges, Switzerland

© 2022 Eaton  
All Rights Reserved  
Publication No. CA010002EN  
Article number 301974-MK  
January 2022

Changes to the products, to the information contained in this document, and to prices are reserved; as are errors and omissions. Only order confirmations and technical documentation by Eaton is binding. Photos and pictures also do not warrant a specific layout or functionality. Their use in whatever form is subject to prior approval by Eaton. The same applies to trademarks (especially Eaton, Moeller, and Cutler-Hammer). The Terms and Conditions of Eaton apply, as referenced on Eaton Internet pages and Eaton order confirmations.

Eaton is a registered trademark.

All other trademarks are property of their respective owners.

Follow us on social media to get the latest product and support information.

