

# Productinformatieblad

Specificaties



## Driedubbele drukknoppen, Verzonken, Ø22mm, Met markering, Groen / rood

ZB4BA7341

EAN Code: 3389119043847

**Prijs: 17,75 EUR**

### Hoofd

range of product	Harmony XB4
product of component type	Kop voor drukknop met dubbele kop
device short name	ZB4
kraag materiaal	Verchroomd metaal
bevestigingsdiameter	22 mm
koptype	Standaard
verkoop per ondeelbare hoeveelheid	1
vorm van kop signaleringseenheid	Rechthoekig
type operator	terugverend
operator profiel	2 standaard knoppen
operatorbeschrijving	Groen 'I' - rood 'O'

### Complementair

gewicht product	0,056 kg
weerstand hoge druk drukkring	7000000 Pa om 55 °C, afstand: 0.1 m
kleur van markering	Zwarte markering bij witte schildjes Witte markering bij groene, rode of zwarte schildjes
operator profiel	Groen verzonken, I (wit) Rood verzonken, O (wit)
mechanical durability	1000000 cycles
elektrische samenstellingscode	C3 voor <6 contacten gebruik enkelvoudig blokken in vooraan gemonteerd C4 voor <6 contacten gebruik enkelvoudig en dubbel blokken in vooraan gemonteerd C14 voor <2 contacten gebruik enkelvoudig blokken in vooraan gemonteerd
product presentatie	Basisonderdeel

### Omgeving

ambient air temperature for storage	-40...70 °C
omgevingstemperatuur voor werking	-40...70 °C
beschermingsklasse tegen elektrische schokken	Klasse I In overeenstemming met IEC 60536
IP beschermingsgraad	IP67 In overeenstemming met IEC 60529 IP69 In overeenstemming met IEC 60529 IP66 In overeenstemming met IEC 60529
Enclosure Type	UL type 4X/13

De weergegeven prijs is de adviesprijs in euro excl. BTW. Deze kan onderhevig zijn aan korting. Neem contact op met uw lokale distributeur of detailhandel voor de daadwerkelijke prijs

<b>IK-beschermingsgraad</b>	IK06 In overeenstemming met IEC 50102
<b>standards</b>	IEC 60947-5-5 CSA C22.2 Nr 14 UL 508 IEC 60947-5-4 JIS C8201-5-1 IEC 60947-5-1 IEC 60947-1 JIS C8201-1
<b>product certifications</b>	CSA LROS (Lloyds register of shipping) BV UL listed DNV
<b>trilling bestendigheid</b>	5 gn (f= 2...500 Hz) In overeenstemming met IEC 60068-2-6
<b>schokbestendigheid</b>	30 gn (duur = 18 ms) voor halve sinusgolf versnelling In overeenstemming met IEC 60068-2-27 50 gn (duur = 11 ms) voor halve sinusgolf versnelling In overeenstemming met IEC 60068-2-27

## Verpakkingseenheid

<b>Eenheidstype van verpakking 1</b>	PCE
<b>Aantal eenheden in verpakking 1</b>	1
<b>verpakking 1 hoogte</b>	5,500 cm
<b>verpakking 1 breedte</b>	3,500 cm
<b>verpakking 1 lengte</b>	5,500 cm
<b>verpakking_1_gewicht</b>	58,000 g
<b>Eenheidstype van verpakking 2</b>	S03
<b>Aantal eenheden in verpakking 2</b>	200
<b>verpakking 2 hoogte</b>	30,000 cm
<b>verpakking 2 breedte</b>	30,000 cm
<b>verpakking 2 lengte</b>	40,000 cm
<b>verpakking 2 gewicht</b>	12,076 kg

## contractuele waarborg

<b>Garantie (in maanden)</b>	18
------------------------------	----

Schneider Electric wil tegen 2050 de Net Zero-status hebben bereikt via partnerschappen in de toeleveringsketen, materialen met een lagere impact en circulariteit via onze doorlopende campagne "Use Better, Use Longer, Use Again" om de levensduur van producten en de recycleerbaarheid te verlengen.

[Uitleg van Environmental Data >](#)

[Hoe evalueren we de duurzaamheid van producten? >](#)

### Milieuoetafdruk

Totale levenscyclus ecologische voetafdruk	0.5 kg CO2 eq.
Koolstofvoetafdruk van de fabricagefase [A1–A3]	0.4 kg CO2 eq.
Koolstofvoetafdruk van de distributiefase [A4]	0 kg CO2 eq.
Koolstofvoetafdruk van de installatiefase [A5]	0 kg CO2 eq.
Koolstofvoetafdruk van de gebruiksfase [B2, B3, B4, B6]	0 kg CO2 eq.
Koolstofvoetafdruk van de einde-levensfase [C1–C4]	0.1 kg CO2 eq.

## Use Better

### Materialen en verpakking

Gemiddeld percentage gerecycleerde kunststof	14 %
Gemiddeld percentage gerecycleerd metaal	21 %
Pakket met gerecycleerd karton	Ja
Verpakkingen zonder kunststof	Ja
RoHS-richtlijn van de EU	<a href="#">Conform</a>
REACH-verordening	<a href="#">Referentie bevat geen SVHC boven drempelwaarde</a>

## Use Longer

### Levensduurverlenging

Reparatie	Nee
-----------	-----

## Use Again

### Herverpakken en herfabriceren

Circulair Profiel	<a href="#">Informatie over einde levensduur</a>
Terugname	Ja

Dimensions Drawings

Dimensions

---

Without Boot

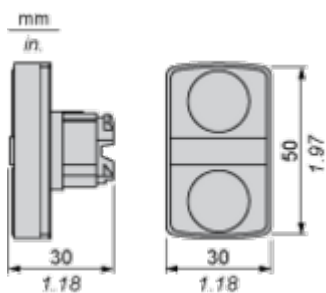

Without Boot ZBA708

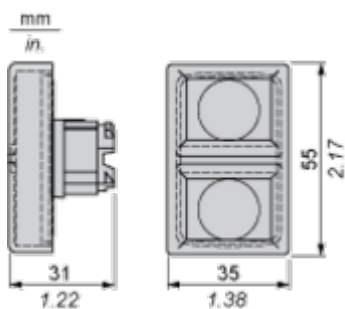

Mounting and Clearance

Panel Cut-out for Pushbuttons, Switches and Pilot Lights (Finished Holes, Ready for Installation)

Connection by Screw Clamp Terminals or Plug-in Connectors or on Printed Circuit Board	Connection by Faston Connectors
	
<p>(1) Diameter on finished panel or support                  (2) 40 mm min. / 1.57 in. min.                  (3) 30 mm min. / 1.18 in. min.                  (4) <math>\varnothing 22.5 \text{ mm} / 0.89 \text{ in. recommended } (\varnothing 22.3 \text{ mm }_0^{+0.4} / 0.88 \text{ in. }_0^{+0.016})</math>                  (5) 45 mm min. / 1.78 in. min.                  (6) 32 mm min. / 1.26 in. min.</p>	





A: 1.18 in. min.

B: 1.57 in. min.

**General Tolerances of the Panel and Printed Circuit Board**

The cumulative tolerance must not exceed 0.3 mm / 0.012 in: T1 + T2 = 0.3 mm max.

**Installation Precautions**

- Minimum thickness of circuit board: 1.6 mm / 0.06 in.
- Cut-out diameter: 22.4 mm ± 0.1 / 0.88 in. ± 0.004
- Orientation of body/fixing collar ZB4 BZ009: ± 2° 30' (excluding cut-outs marked a and b).
- Tightening torque of screws ZBZ 006: 0.6 N.m (5.3 lbf.in) max.
- Allow for one ZB4 BZ079 fixing collar/pillar and its fixing screws:
  - every 90 mm / 3.54 in. horizontally (X), and 120 mm / 4.72 in. vertically (Y).
  - with each selector switch head (ZB4 BD\*, ZB4 BJ\*, ZB4 BG\*).

The fixing centers marked a and b are diagonally opposed and must align with those marked 4 and 5.



(1) Panel

(2) Printed circuit board

#### Mounting of Adapter (Socket) ZBZ 01•

- 1 2 elongated holes for ZBZ 006 screw access
- 2 1 hole  $\varnothing 2.4 \text{ mm} \pm 0.05 / 0.09 \text{ in.} \pm 0.002$  for centring adapter ZBZ 01•
- 3  $8 \times \varnothing 1.2 \text{ mm} / 0.05 \text{ in.}$  holes
- 4 1 hole  $\varnothing 2.9 \text{ mm} \pm 0.05 / 0.11 \text{ in.} \pm 0.002$ , for aligning the printed circuit board (with cut-out marked a)
- 5 1 elongated hole for aligning the printed circuit board (with cut-out marked b)
- 6 4 holes  $\varnothing 2.4 \text{ mm} / 0.09 \text{ in.}$  for clipping in adapter ZBZ 01•

Dimensions An + 18.1 relate to the  $\varnothing 2.4 \text{ mm} \pm 0.05 / 0.09 \text{ in.} \pm 0.002$  holes for centring adapter ZBZ 01•.

Technical Description

Electrical Composition Corresponding to Code C3

---



Electrical Composition Corresponding to Code C4

---



Electrical Composition Corresponding to Codes C14, SF2 and SR2



**Legend**

---

Single contact



Double contact



Light block



Possible location



Technical Illustration

Dimensions

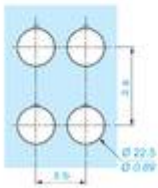
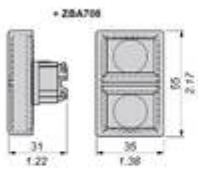
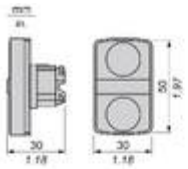

		a (mm)	a (in.)	b (mm)	b (in.)
		40	1.57	30	1.18
ZBE*****	ZD*****				
		45	1.77	32	1.26
ZBE*****5	ZD*****3				
		40	1.57	30	1.18
ZDE*****4	ZD*****4				
		50	1.97	30	1.18
ZDE*****5	ZD*****5				
		40	1.57	30	1.18
ZDE*****9	ZD*****9				
ZBRT*	ZBRV1	40	1.57	30	1.18

Offer Marketing Illustration

Product benefits / Features

---

## Technical Benefits

### Harmony XB4

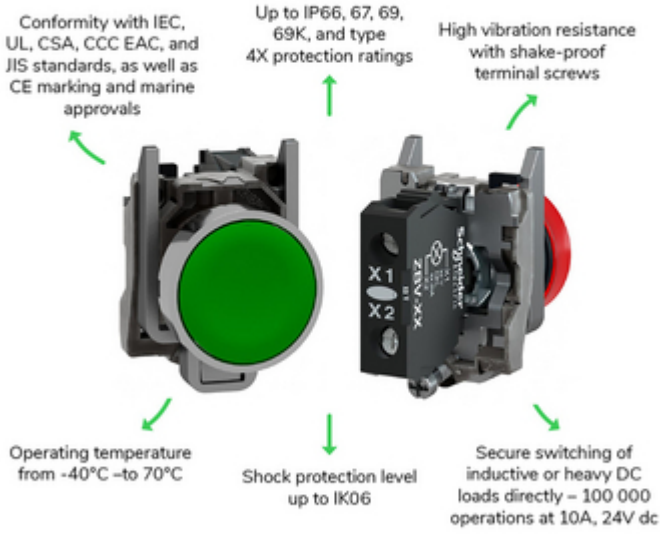

Offer Marketing Illustration

Product benefits / Features

---

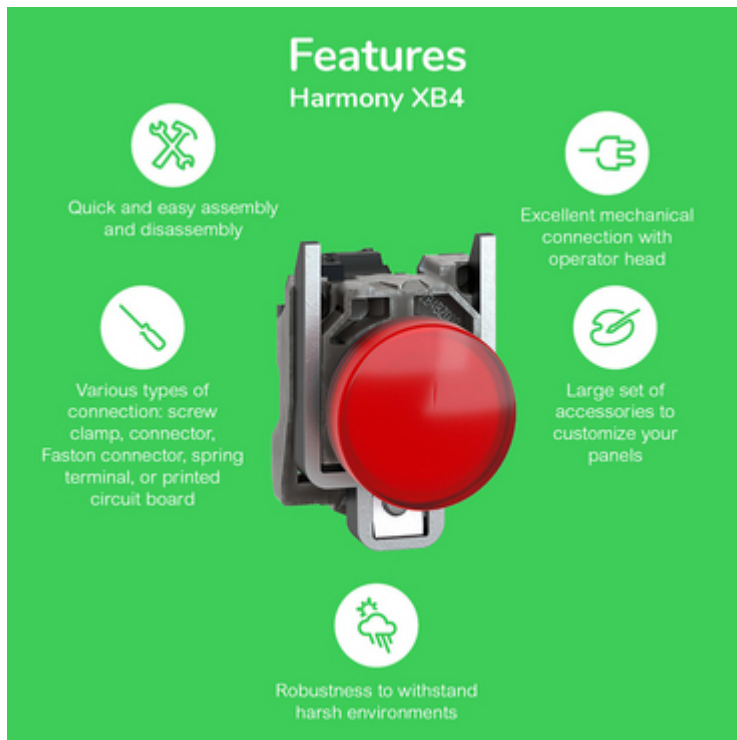

The infographic features a central image of a red Schneider XB4 terminal block against a green background. Surrounding the central image are five circular icons, each with a corresponding text description of a feature. The features are: quick and easy assembly and disassembly (wrench and screwdriver icon), excellent mechanical connection with operator head (hand icon), various types of connection (screw clamp, connector, Faston connector, spring terminal, or printed circuit board) (screwdriver icon), a large set of accessories to customize panels (screwdriver icon), and robustness to withstand harsh environments (lightning bolt icon).

### Features Harmony XB4

- Quick and easy assembly and disassembly
- Excellent mechanical connection with operator head
- Various types of connection: screw clamp, connector, Faston connector, spring terminal, or printed circuit board
- Large set of accessories to customize your panels
- Robustness to withstand harsh environments

Image of product / Alternate images

Alternative

---

