





36 210 985



- Drehumstellung
- Rosette 60 x 60 mm

Passt zu IMO

Passt zu IMO

	Platin gebürstet	36 210 985-06
	Chrom	36 210 985-00
	Light Gold gebürstet	36 210 985-27
	Messing gebürstet (23kt Gold)	36 210 985-28
	Champagne gebürstet (22kt Gold)	36 210 985-46
	Champagne (22kt Gold)	36 210 985-47
	Dark Platinum gebürstet	36 210 985-99

Benötigtes Zubehör



UP-Dreiwege-Umstellung -

35 203 970 90

- Max. Einbautiefe 160 mm
- Min. Einbautiefe 85 mm

36 210 985

mm [inches]

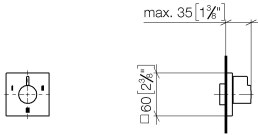

Durchflussdiagramm



Codes & Standards

DIN 4109

ISO 3822

Scottish Water
Byelaws

UK Water Supply
Regulations

Ü-Zeichen



SYMETRICS UP-Dreiwege-Umstellung - Platin gebürstet

IMO

36 210 985

Zertifikate

WRAS_2307

LGA_38

36 210 985

Produktversion ab 4/1/2022

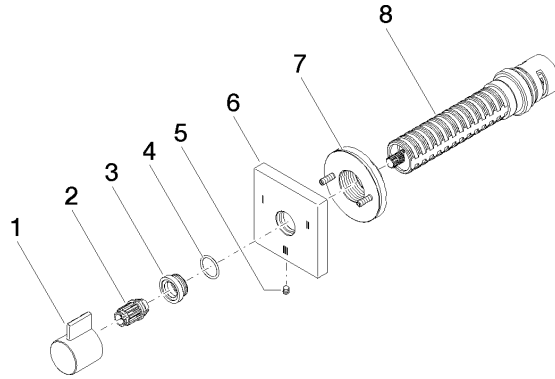



SYMETRICS UP-Dreiwege-Umstellung - Platin gebürstet

IMO

36 210 985

Ersatzteilstückliste

Produktversion ab 4/1/2022

Nr.	Artikelnummer	Benennung	Verbaumenge	Lieferzeit
	09 20 98 002-06	Griff mit Nase Ø 25 x 25 mm - Platin gebürstet	8	10