

Towel bar - Brushed Dark Bronze (PVD)













SERIES SPECIFIC

83 080 979 Product version from 7/1/2023



- gauge 800 mm
- width 840mm
- height 40 mm
- rosette Ø 40 mm
- 65mm projection

Fits ELIO, ENO, MEM, META SQUARE, SYNC and TARA ULTRA

	Brushed Dark Bronze (PVD)	83 080 979-43
	Chrome	83 080 979-00
	Brushed Platinum	83 080 979-06
	Dark Chrome	83 080 979-19
	Brushed Durabronze (23kt Gold)	83 080 979-28
	Matte Black	83 080 979-33
	Brushed Gold (PVD)	83 080 979-37
	Brushed Dark Brass (PVD)	83 080 979-39
	Brushed Bronze (PVD)	83 080 979-42
	Brushed Champagne (22kt Gold)	83 080 979-46
	Champagne (22kt Gold)	83 080 979-47
	Brushed Chrome	83 080 979-93
	Brushed Dark Platinum	83 080 979-99

83 080 979 Product version from 7/1/2023

mm [inches]

M 1:10

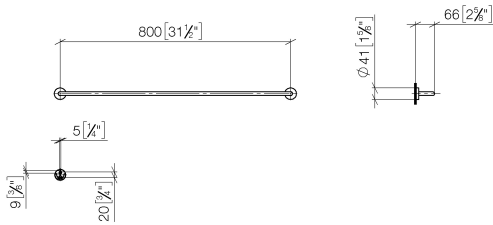

83 080 979 Product version from 7/1/2023

Parts for other finishes can be found here: [Chrome](#)

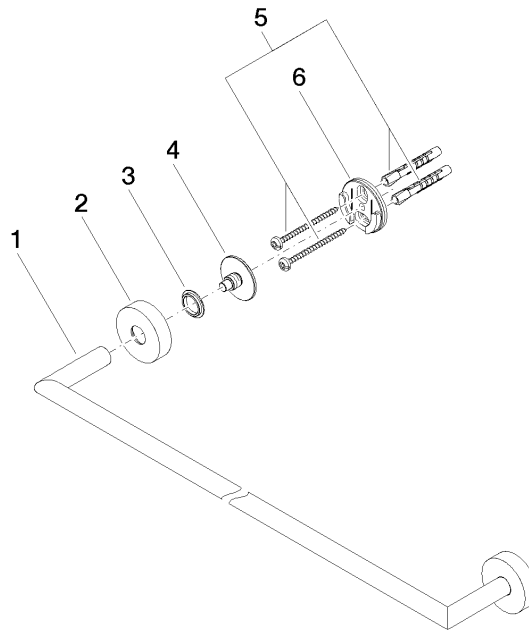

Spare parts list

No.	Item Number	Name	Quantity used	Delivery time
5	05 30 31 025 00 90	Mounting Bolt Round head 4,5 x 60 mm -	2.00	14
6	08 17 97 501 07	Holder Ø 38 x 9 mm -	2.00	14
3	08 30 11 516 90	Ring Ø 20 x 3 mm -	2.00	14
4	08 17 97 560 90	Holder Ø 32 x 16 mm -	2.00	14
2	08 27 97 500-43	rosette	2.00	82
1	05 28 22 623 00-43	holder	1.00	-

Spare part can no longer be ordered, please order the replacement item