

Edition 11

3125130000 Waschtischunterbau

**PRODUKT**

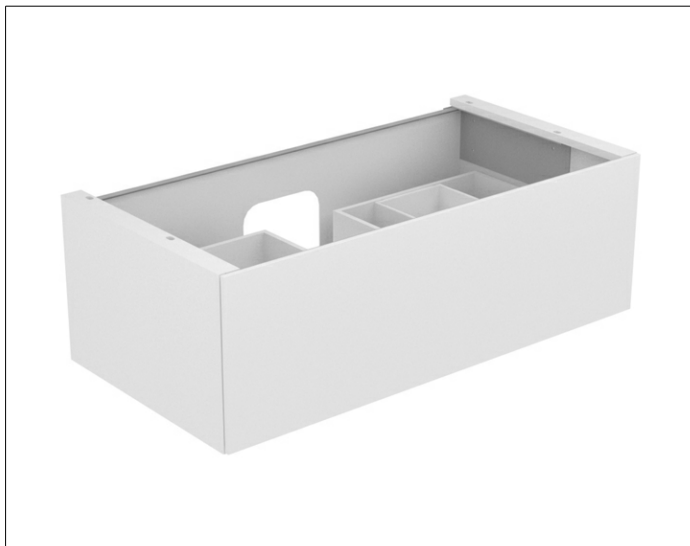

**ZEICHNUNG**

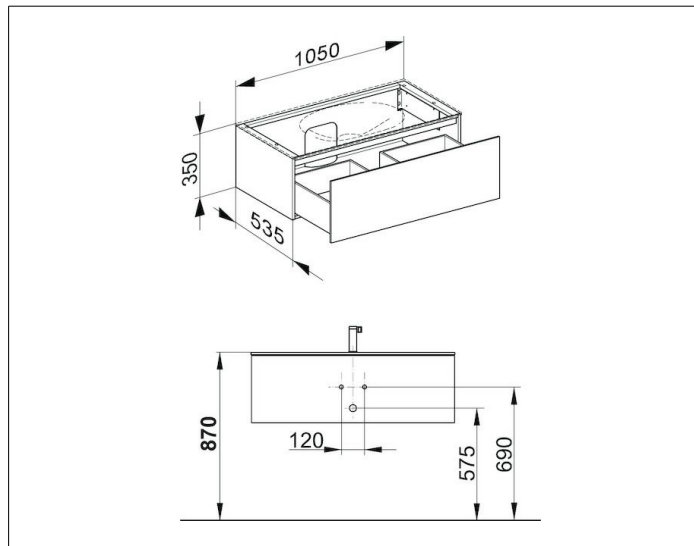

**OBERFLÄCHE**

weiß/Glas weiß

**ABMESSUNG**

1050 x 350 x 535 mm