

Product data sheet Spirotech

Product name

SpiroVent -DN80 -Weld -HiFlow

Product properties

A steel (microbubble) deaerator for high flow rate (3 m/s) with a DN50 - DN150 weld connection

- Removes all circulating air and micro bubbles effectively
- Applicable for high flow rate systems (3 m/s)
- Removes trapped air when installed at the correct location
- Greatly reduces the need for manual venting
- Applicable with 50/50 Glycol / Water (Volume)
- Constant low-pressure drop
- No unnecessary shutdown
- Weld connections
- Connection diameters from DN50 to DN150, larger diameters available on request
- Exceptional guarantee

Article number

HA080L

Product image



Product dimensions

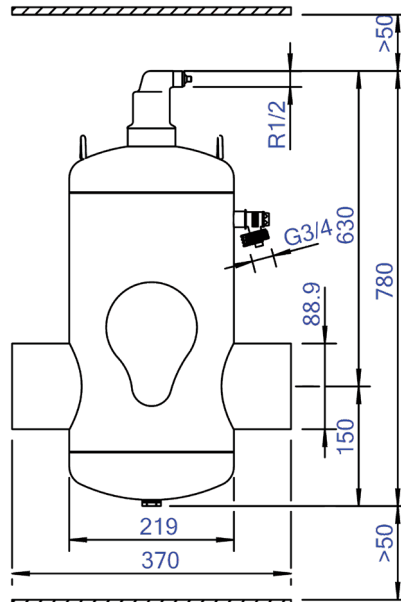

Product data sheet Spirotech

ETIM product data

Housing material	Steel	Construction length	370 mm
With drain valve	No	Article compression class	PN 10
Housing material quality	St 37 (1.0254)	Surface protection	Lacquered
Backwash filter	No	Suitable for open system	No
Medium temperature (continuous)	0 - 110 °C	Suitable for closed system	Yes
Max. operating pressure	10 bar	Suitable for solar	No
KVS value [m ³ /h] at ΔP 1 bar	153.4 m ³ /h	With dismountable filter	No
Variable flow direction	Yes	Filter volume	25 l
With insulation	No	Magnet operating principle	No
Separator type	Air	With automatic de-aerator	Yes
Connection	Welded end	With couplers	No
Model	Horizontal	Inlet/outlet offset distance	0 mm
Nominal diameter	DN 80	Material of connection	Steel
Max. glycol mixture	50 %	Flow-through capacity	0 - 54 m ³ /h
Suitable for heating	Yes	Flange standard	Other
Suitable for cooling	Yes		

Disclaimer

This product sheet has been compiled with the greatest possible care. Nevertheless, it may contain errors or omissions. For the most current and correct information we refer you to our website

