







36 210 980

- Drehumstellung
- Rosette 60 x 60 mm

Passt zu IMO



	Light Gold gebürstet	36 210 980-27
	Chrom	36 210 980-00
	Platin gebürstet	36 210 980-06
	Messing gebürstet (23kt Gold)	36 210 980-28
	Champagne gebürstet (22kt Gold)	36 210 980-46
	Champagne (22kt Gold)	36 210 980-47
	Dark Platinum gebürstet	36 210 980-99

36 210 980

mm [inches]

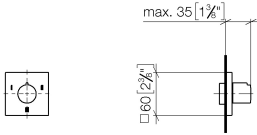

Durchflussdiagramm



Codes & Standards

DIN 4109

ISO 3822

Scottish Water
Byelaws

UK Water Supply
Regulations

Ü-Zeichen



SYMETRICS UP-Dreiwege-Umstellung - Light Gold gebürstet

IMO

36 210 980

Zertifikate

WRAS_2307

LGA_38

36 210 980

Ersatzteile für die
anderen
Oberflächenvarianten
finden Sie hier:
Chrom

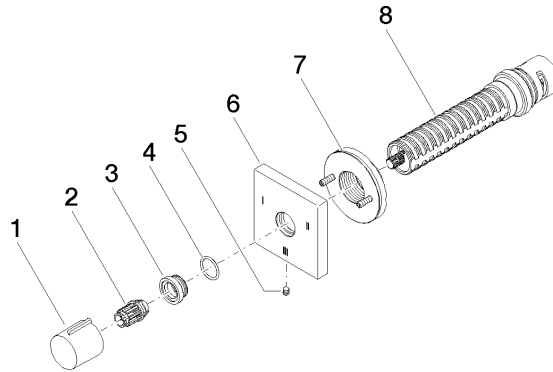



Ersatzteilstückliste