

# Productinformatieblad

Specificaties



## Harmony XB5, Kop sleutelschakelaar, 2 standen, Ø22mm, Zwart, Dom 8D1

ZB5AG2D

EAN Code: 3389110136463

**Prijs: 38,80 EUR**

### Hoofd

range of product	Harmony XB5
product of component type	Kop voor sleutelkeuzeschakelaar
device short name	ZB5
kraag materiaal	Donkergrijs kunststof
bevestigingsdiameter	22 mm
koptype	Standaard
verkoop per ondeelbare hoeveelheid	1
vorm van kop signaleringseenheid	Rond
type operator	blijven
operator profiel	Zwart sleutelschakelaar
informatie positie operator	2 standen 90°
type slot met sleutel	Dom 8D1
terugtrekpositie sleutel	Links

### Complementair

CAD totale breedte	29 mm
CAD totale hoogte	29 mm
CAD totale diepte	72 mm
gewicht product	0,057 kg
mechanical durability	1000000 cycles
naam station	XALD 1...5 uitsnijdingen XALK 2...5 uitsnijdingen
elektrische samenstellingscode	C4 voor <6 contacten gebruik enkelvoudig en dubbel blokken in vooraan gemonteerd C5 voor <5 contacten gebruik enkelvoudig blokken in vooraan gemonteerd C6 voor <5 contacten gebruik enkelvoudig en dubbel blokken in vooraan gemonteerd C7 voor <4 contacten gebruik enkelvoudig blokken in vooraan gemonteerd C8 voor <4 contacten gebruik enkelvoudig en dubbel blokken in vooraan gemonteerd C11 voor <3 contacten gebruik enkelvoudig blokken in vooraan gemonteerd C3 voor <6 contacten gebruik enkelvoudig blokken in vooraan gemonteerd SF1 voor <3 contacten gebruik enkelvoudig blokken in vooraan gemonteerd SR1 voor <3 contacten gebruik enkelvoudig blokken in montage aan achterzijde C15 voor <1 contacten gebruik enkelvoudig blokken in vooraan gemonteerd
product presentatie	Basisonderdeel

### Omgeving

beschermende behandeling	TH
--------------------------	----

De weergegeven prijs is de adviesprijs in euro excl. BTW. Deze kan onderhevig zijn aan korting. Neem contact op met uw lokale distributeur of detailhandel voor de daadwerkelijke prijs

ambient air temperature for storage	-40...70 °C
omgevingstemperatuur voor werking	-40...70 °C
overvoltage category	Klasse II In overeenstemming met IEC 60536
IP beschermingsgraad	IP66 In overeenstemming met IEC 60529 IP67 IP69 IP69K
Enclosure Type	UL type 4X/13
weerstand hoge druk drukring	7000000 Pa om 55 °C, afstand: 0.1 m
IK-beschermingsgraad	IK06 In overeenstemming met IEC 50102
standards	IEC 60947-1 UL 508 CSA C22.2 Nr 14 JIS C8201-5-1 IEC 60947-5-1 IEC 60947-5-4 JIS C8201-1
product certifications	DNV CSA BV LROS (Lloyds register of shipping) UL listed
trilling bestendigheid	5 gn (f= 2...500 Hz) In overeenstemming met IEC 60068-2-6
schokbestendigheid	30 gn (duur = 18 ms) voor halve sinusgolf versnelling In overeenstemming met IEC 60068-2-27 50 gn (duur = 11 ms) voor halve sinusgolf versnelling In overeenstemming met IEC 60068-2-27

## Verpakkingseenheid

Eenheidstype van verpakking 1	PCE
Aantal eenheden in verpakking 1	1
verpakking 1 hoogte	3,500 cm
verpakking 1 breedte	5,500 cm
verpakking 1 lengte	9,100 cm
verpakking_1_gewicht	67,000 g
Eenheidstype van verpakking 2	BB1
Aantal eenheden in verpakking 2	5
verpakking 2 hoogte	8,800 cm
verpakking 2 breedte	3,400 cm
verpakking 2 lengte	26,600 cm
verpakking 2 gewicht	336,000 g
Eenheidstype van verpakking 3	S03
Aantal eenheden in verpakking 3	100
verpakking_3_hoogte	30,000 cm
verpakking 3 breedte	30,000 cm
verpakking 3 lengte	40,000 cm
verpakking 3 gewicht	7,153 kg

## contractuele waarborg



Schneider Electric wil tegen 2050 de Net Zero-status hebben bereikt via partnerschappen in de toeleveringsketen, materialen met een lagere impact en circulariteit via onze doorlopende campagne "Use Better, Use Longer, Use Again" om de levensduur van producten en de recycleerbaarheid te verlengen.

[Uitleg van Environmental Data >](#)

[Hoe evalueren we de duurzaamheid van producten? >](#)

### Milieuoetafdruk

Totale levenscyclus ecologische voetafdruk	0.6 kg CO2 eq.
Koolstofvoetafdruk van de fabricagefase [A1–A3]	0.4 kg CO2 eq.
Koolstofvoetafdruk van de distributiefase [A4]	0 kg CO2 eq.
Koolstofvoetafdruk van de installatiefase [A5]	0 kg CO2 eq.
Koolstofvoetafdruk van de gebruiksfase [B2, B3, B4, B6]	0 kg CO2 eq.
Koolstofvoetafdruk van de einde-levensfase [C1–C4]	0.1 kg CO2 eq.
Milieu Profiel	<a href="#">Milieuprofiel van het product</a>

## Use Better

### Materialen en verpakking

Pakket met gerecycleerd karton	Nee
Verpakkingen zonder kunststof	Nee
SCIP-nummer	F28cb399-1b6a-409d-ac7b-4169e47b25c8
RoHS-richtlijn van de EU	<a href="#">Conform door vrijstelling</a>
REACH-verordening	<a href="#">Referentie bevat zorgwekkende stoffen (SVHC) boven drempelwaarde</a>

## Use Longer

### Levensduurverlenging

Reparatie	Nee
-----------	-----

## Use Again

### Herverpakken en herfabriceren

Circulair Profiel	<a href="#">Informatie over einde levensduur</a>
Terugname	Ja

Dimensions Drawings

Dimensions

---

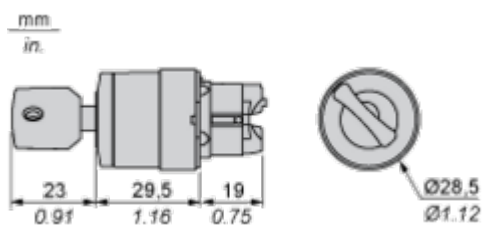

Mounting and Clearance

Panel Cut-out for Pushbuttons, Switches and Pilot Lights (Finished Holes, Ready for Installation)

Connection by Screw Clamp Terminals or Plug-in Connectors or on Printed Circuit Board



- (1) Diameter on finished panel or support
- (2) For selector switches and Emergency stop buttons, use of an anti-rotation plate type ZB5AZ902 is recommended.
- (3) Ø22.5 mm recommended ( $\text{Ø}22.3 \text{ }_0^{+0.4}$ ) / Ø0.89 in. recommended ( $\text{Ø}0.88 \text{ in. }_0^{+0.016}$ )

Connections	a in mm	a in in.	b in mm	b in in.
By screw clamp terminals or plug-in connector	40	1.57	30	1.18
By Faston connectors	45	1.77	32	1.26
On printed circuit board	30	1.18	30	1.18

Detail of Lug Recess



- (1) Diameter on finished panel or support
- (2) For selector switches and Emergency stop buttons, use of an anti-rotation plate type ZB5AZ902 is recommended.
- (3) Ø22.5 mm recommended ( $\text{Ø}22.3 \text{ }_0^{+0.4}$ ) / Ø0.89 in. recommended ( $\text{Ø}0.88 \text{ in. }_0^{+0.016}$ )





A: 1.18 in. min.

B: 1.57 in. min.

**General Tolerances of the Panel and Printed Circuit Board**

The cumulative tolerance must not exceed 0.3 mm / 0.012 in.: T1 + T2 = 0.3 mm max.

**Installation Precautions**

- Minimum thickness of circuit board: 1.6 mm / 0.06 in.
- Cut-out diameter: 22.4 mm ± 0.1 / 0.88 in. ± 0.004
- Orientation of body/fixing collar ZB5AZ009: ± 2° 30' (excluding cut-outs marked a and b).
- Tightening torque of screws ZBZ006: 0.6 N.m (5.3 lbf.in) max.
- Allow for one ZB5AZ079 fixing collar/pillar and its fixing screws:
  - every 90 mm / 3.54 in. horizontally (X), and 120 mm / 4.72 in. vertically (Y).
  - with each selector switch head (ZB5AD\*, ZB5AJ\*, ZB5AG\*).

The fixing centers marked a and b are diagonally opposed and must align with those marked 4 and 5.

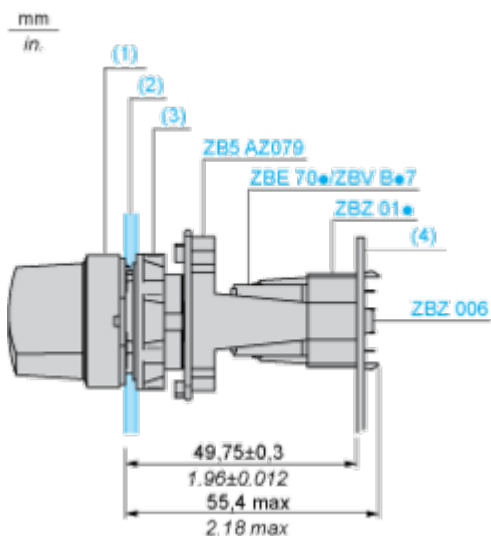

- (1) Head ZB5AD•
- (2) Panel
- (2) Nut
- (4) Printed circuit board

## Mounting of Adapter (Socket) ZBZ01•

- 1 2 elongated holes for ZBZ006 screw access
- 2 1 hole  $\varnothing$  2.4 mm  $\pm$  0.05 / 0.09 in.  $\pm$  0.002 for centring adapter ZBZ01•
- 3 8  $\times$   $\varnothing$  1.2 mm / 0.05 in. holes
- 4 1 hole  $\varnothing$  2.9 mm  $\pm$  0.05 / 0.11 in.  $\pm$  0.002, for aligning the printed circuit board (with cut-out marked **a**)
- 5 1 elongated hole for aligning the printed circuit board (with cut-out marked **b**)
- 6 4 holes  $\varnothing$  2.4 mm / 0.09 in. for clipping in adapter ZBZ01•

Dimensions An + 18.1 relate to the  $\varnothing$  2.4 mm  $\pm$  0.05 / 0.09 in.  $\pm$  0.002 holes for centring adapter ZBZ01•.

Technical Description

Electrical Composition Corresponding to Code C4

---



Electrical Composition Corresponding to Code C5

---

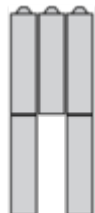

Electrical Composition Corresponding to Code C6

---



Electrical Composition Corresponding to Code C7

---



Electrical Composition Corresponding to Code C8

---



Electrical Composition Corresponding to Code C3

---



Electrical Composition Corresponding to Codes C9, C11, SF1 and SR1

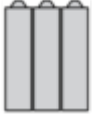

**Legend**

---

Single contact



Double contact



Light block



Possible location



Sequence of Contacts Fitted to 2-position Selector Switch Body

Position 315°



<b>Push</b>	Position	Top			
		Bottom			
	Location		Left	Centre	Right
	State		0	0	0
	Contacts		N/O	open	open
		N/C	closed	closed	closed

Position 45°



<b>Push</b>	Position	Top			
		Bottom			
	Location		Left	Centre	Right
	State		1	1	1
	Contacts		N/O	closed	closed
		N/C	open	open	open

Technical Illustration

Dimensions

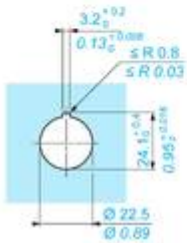
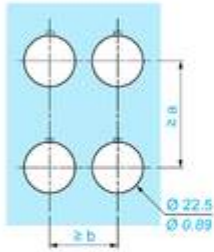
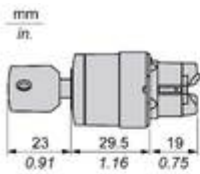

		a (mm)	a (in.)	b (mm)	b (in.)
		40	1.57	30	1.18
ZBE●●●●●	ZBV●●●●●				
		45	1.77	32	1.26
ZBE●●●●●3	ZBV●●●●●3				
		40	1.57	30	1.18
ZBE●●●●●4	ZBV●●●●●4				
		50	1.97	30	1.18
ZBE●●●●●5	ZBV●●●●●5				
		40	1.57	30	1.18
ZBE●●●●●9	ZBV●●●●●9				
		40	1.57	30	1.18
ZBRT●	ZBRV1				

Offer Marketing Illustration

Product benefits / Features

---



The infographic features a central image of a Schneider XB5 terminal block with a grey cover. It is surrounded by five circular icons, each with a corresponding text description of a feature. The background is a solid green color.

### Features Harmony XB5

-  Quick and easy assembly and disassembly
-  Excellent mechanical connection with operator head
-  Various types of connection: screw clamp, connector, Faston connector, spring terminal, or printed circuit board
-  Large set of accessories to customize your panels
-  Robustness to withstand harsh environments

Offer Marketing Illustration

Product benefits / Features

---

## Technical Benefits

Harmony XB5

Conformity with IEC, UL, CSA, CCC EAC, and JIS standards, as well as CE marking and marine approvals

Up to IP66, 67, 69, 69K, and type 4X protection ratings

High vibration resistance with shake-proof terminal screws



Operating temperature from -40°C to 70°C

Shock protection level up to IK06

Secure switching of inductive or heavy DC loads directly – 100 000 operations at 10A, 24V dc

Image of product / Alternate images

Alternative

---





