

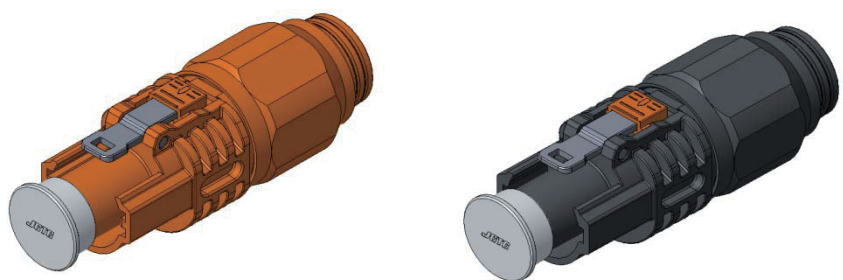

# Male Connector Installation Manual

35mm<sup>2</sup> DC Cable



## 1. Structure Description

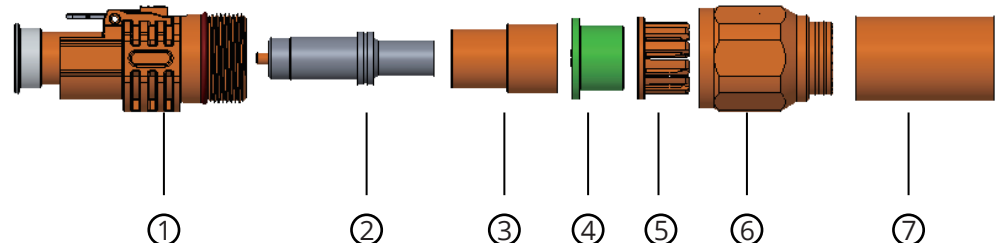

①	Body of the connector	2	⑤	Claw	2
②	Metal terminal	2	⑥	Back cover	2
③	Support sleeve	2	⑦	Heat-shrinkable sleeve	2
④	Sealing gasket	2			

2. Put the heat-shrinkable sleeve, back cover, claw, sealing gasket and support sleeve on the cable in sequence.

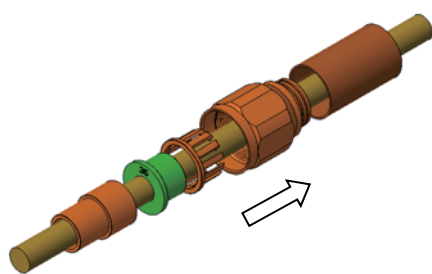

3. Strip the cable for 20 mm. And cover the stripped cable core with the metal terminal.

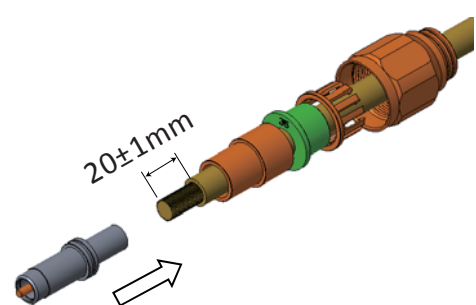

4. Clamp the terminal with a hydraulic clamp. (Pay attention that the right size dies should be chosen.)

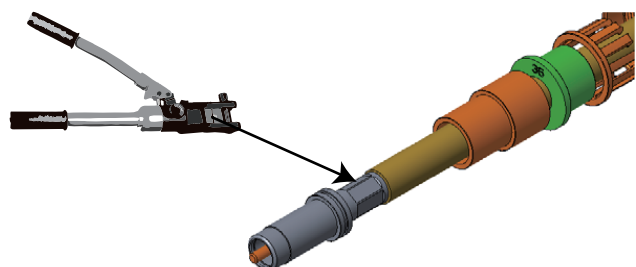

Qualified clamped cable data:

Crimp width(mm)	Crimp height(mm)	Pull-out force (N)
(15.0) (2.0)	8.9 ~ 9.2	≥ 2300N

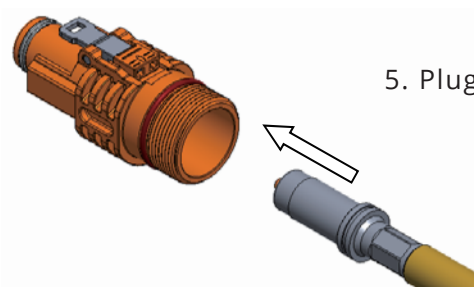

5. Plug the clamped terminal into the body.

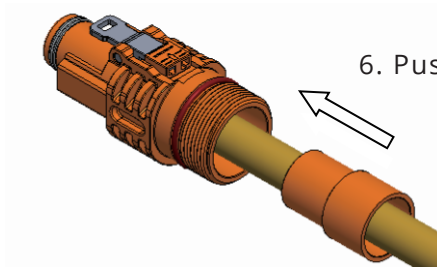

6. Push the support sleeve inside of the body.

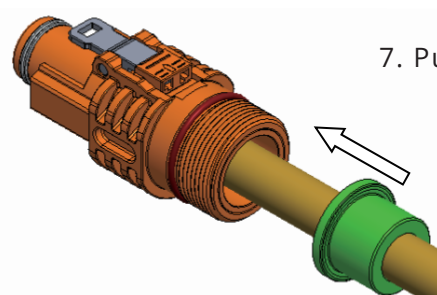

7. Push the sealing gasket close to the body.

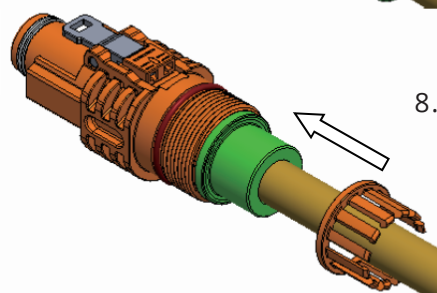

8. Cover the sealing gasket with the claw.

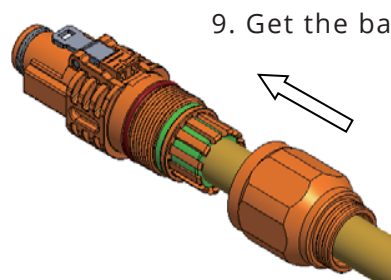

9. Get the back cover close to the body, and tighten them.

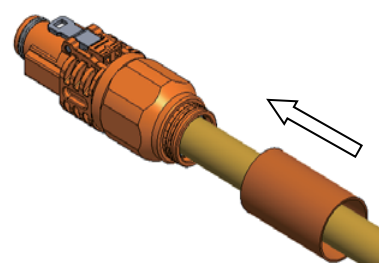

10. Get the heat shrinkable sleeve on the step of the back cover. Blow hot air, and make them fit well.

11. Remove the plastic cover before plugging it into the battery system.

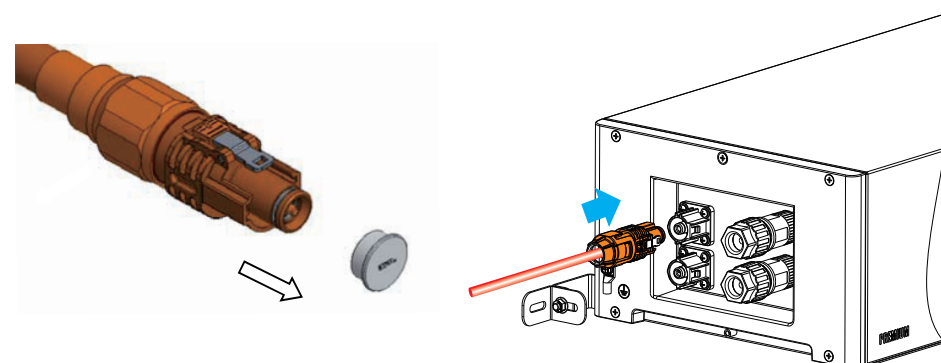

## Contact

**Australia:** Alps Power Pty Ltd  
service@alpspower.com.au  
Telephone:+61 2 8005 6688

**USA:** BYD US Service  
bboxusservice@byd.com  
Telephone:+1(833)338-8721

**LATAM:**  
BYD LATAM Service  
bboxservLATgrp@byd.com

**Europe:** EFT-Systems GmbH  
service@eft-systems.de  
Telephone:  
+49 9352 8523999  
+44(0)2037695998(UK)  
+34 91 060 22 67(ES)  
+39 0287 368364(IT)

**South Africa:**  
AFRIPLUS ENERGY GROUP (PTY)  
LTD  
Support@afriplusenergy.co.za  
Telephone:+27 21 140 3594

**BYD Global Service:**  
bboxservice@byd.com  
Telephone:  
+86 755 89888888-47175

Service policy is subject to BYD's product warranty.

Economic Operator In Europe: BYD Smart Device Hungary kft.

Brand: BYD

Address: H-2071 paty,Szeng Jozsef ut 4.