

Productinformatieblad

Specificaties

selector switch head key 455 3-position return center cp grey



ZB5AG7C0

EAN Code: 3606489766108

Prijs: 42,35 EUR

Hoofd

range of product	Harmony XB5
product of component type	Kop voor sleutelkeuzeschakelaar
device short name	ZB5
kraag materiaal	Kunststof gekleurd grijs
bevestigingsdiameter	22 mm
koptype	Standaard
verkoop per ondeelbare hoeveelheid	1
vorm van kop signaleringseenheid	Rond
type operator	Naar het midden terugverend
operator profiel	Zwart sleutelschakelaar
informatie positie operator	3 standen +/- 45°
type slot met sleutel	Sleutel 455
terugtrekpositie sleutel	Midden

Complementair

CAD totale breedte	29 mm
CAD totale hoogte	29 mm
CAD totale diepte	72 mm
gewicht product	0,057 kg
mechanical durability	1000000 cycles
naam station	XALD 1...5 uitsnijdingen XALK 2...5 uitsnijdingen
elektrische samenstellingscode	C4 voor <6 contacten gebruik enkelvoudig en dubbel blokken in vooraan gemonteerd C5 voor <5 contacten gebruik enkelvoudig blokken in vooraan gemonteerd C6 voor <5 contacten gebruik enkelvoudig en dubbel blokken in vooraan gemonteerd C7 voor <4 contacten gebruik enkelvoudig blokken in vooraan gemonteerd C8 voor <4 contacten gebruik enkelvoudig en dubbel blokken in vooraan gemonteerd C11 voor <3 contacten gebruik enkelvoudig blokken in vooraan gemonteerd C3 voor <6 contacten gebruik enkelvoudig blokken in vooraan gemonteerd SF1 voor <3 contacten gebruik enkelvoudig blokken in vooraan gemonteerd SR1 voor <3 contacten gebruik enkelvoudig blokken in montage aan achterzijde
product presentatie	Basisonderdeel

Omgeving

beschermende behandeling	TH
ambient air temperature for storage	-40...70 °C

De weergegeven prijs is de adviesprijs in euro excl. BTW. Deze kan onderhevig zijn aan korting. Neem contact op met uw lokale distributeur of detailhandel voor de daadwerkelijke prijs

omgevingstemperatuur voor werking	-40...70 °C
overvoltage category	Klasse II In overeenstemming met IEC 60536
IP beschermingsgraad	IP66 In overeenstemming met IEC 60529 IP67
Enclosure Type	UL type 4X/13
weerstand hoge druk drukring	7000000 Pa om 55 °C, afstand: 0.1 m
IK-beschermingsgraad	IK06 In overeenstemming met IEC 50102
standards	IEC 60947-5-1 JIS C8201-5-1 IEC 60947-1 UL 508 IEC 60947-5-4 CSA C22.2 Nr 14 JIS C8201-1
product certifications	DNV CSA BV LROS (Lloyds register of shipping) UL listed
trilling bestendigheid	5 gn (f= 2...500 Hz) In overeenstemming met IEC 60068-2-6
schokbestendigheid	30 gn (duur = 18 ms) voor halve sinusgolf versnelling In overeenstemming met IEC 60068-2-27 50 gn (duur = 11 ms) voor halve sinusgolf versnelling In overeenstemming met IEC 60068-2-27

Verpakkingseenheid

Eenheidstype van verpakking 1	PCE
Aantal eenheden in verpakking 1	1
verpakking 1 hoogte	3,400 cm
verpakking 1 breedte	5,300 cm
verpakking 1 lengte	9,100 cm
verpakking_1_gewicht	66,000 g

contractuele waarborg

Garantie (in maanden)	18
------------------------------	----

Schneider Electric wil tegen 2050 de Net Zero-status hebben bereikt via partnerschappen in de toeleveringsketen, materialen met een lagere impact en circulariteit via onze doorlopende campagne "Use Better, Use Longer, Use Again" om de levensduur van producten en de recycleerbaarheid te verlengen.

[Uitleg van Environmental Data](#) >

[Hoe evalueren we de duurzaamheid van producten?](#) >

Milieuoetadruk

Milieu Profiel

[Milieuprofiel van het product](#)

Use Better

Materialen en verpakking

Pakket met gerecycleerd karton

Ja

Verpakkingen zonder kunststof

Ja

SCIP-nummer

F28cb399-1b6a-409d-ac7b-4169e47b25c8

RoHS-richtlijn van de EU

[Conform door vrijstelling](#)

REACH-verordening

[Referentie bevat zorgwekkende stoffen \(SVHC\) boven drempelwaarde](#)

Use Longer

Levensduurverlenging

Reparatie

Nee

Use Again

Herverpakken en herfabriceren

Circulair Profiel

[Informatie over einde levensduur](#)

Terugname

Ja

Dimensions Drawings

Dimensions

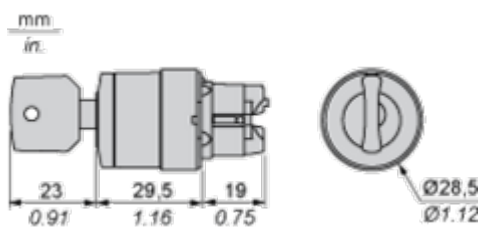

Mounting and Clearance

Panel Cut-out for Pushbuttons, Switches and Pilot Lights (Finished Holes, Ready for Installation)

Connection by Screw Clamp Terminals or Plug-in Connectors or on Printed Circuit Board



- (1) Diameter on finished panel or support
- (2) For selector switches and Emergency stop buttons, use of an anti-rotation plate type ZB5AZ902 is recommended.
- (3) Ø22.5 mm recommended (Ø22.3₀^{+0.4}) / Ø0.89 in. recommended (Ø0.88 in.₀^{+0.016})

Connections	a in mm	a in in.	b in mm	b in in.
By screw clamp terminals or plug-in connector	40	1.57	30	1.18
By Faston connectors	45	1.77	32	1.26
On printed circuit board	30	1.18	30	1.18

Detail of Lug Recess



- (1) Diameter on finished panel or support
- (2) For selector switches and Emergency stop buttons, use of an anti-rotation plate type ZB5AZ902 is recommended.
- (3) Ø22.5 mm recommended (Ø22.3₀^{+0.4}) / Ø0.89 in. recommended (Ø0.88 in.₀^{+0.016})

Pushbuttons, Switches and Pilot Lights for Printed Circuit Board Connection

Panel Cut-outs (Viewed from Installer's Side)

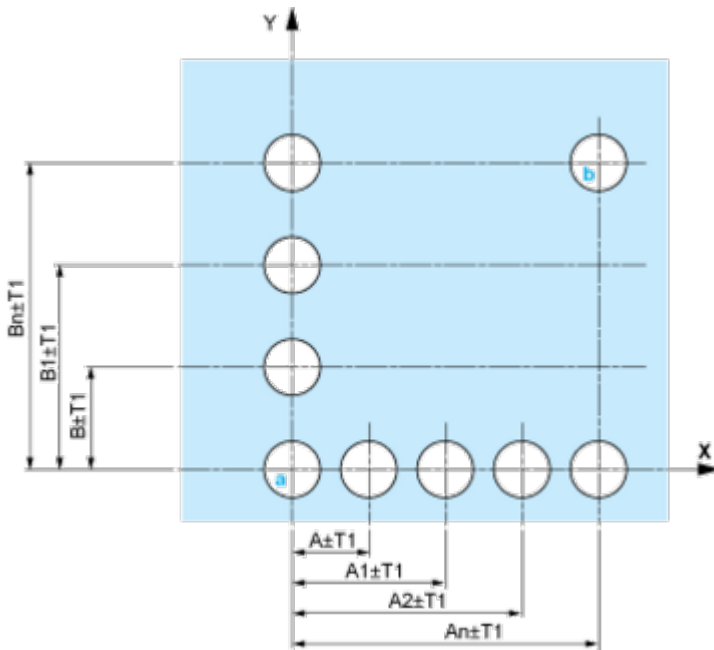

A: 30 mm min. / 1.18 in. min.

B: 40 mm min. / 1.57 in. min.

Printed Circuit Board Cut-outs (Viewed from Electrical Block Side)

Dimensions in mm

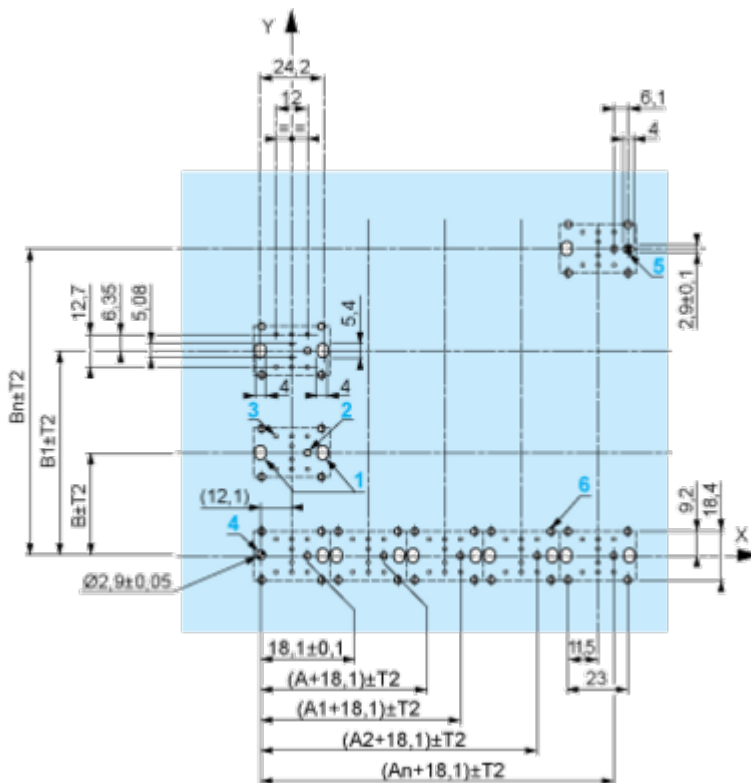

A: 30 mm min.

B: 40 mm min.

Dimensions in in.



A: 1.18 in. min.

B: 1.57 in. min.

General Tolerances of the Panel and Printed Circuit Board

The cumulative tolerance must not exceed 0.3 mm / 0.012 in.: T1 + T2 = 0.3 mm max.

Installation Precautions

- Minimum thickness of circuit board: 1.6 mm / 0.06 in.
- Cut-out diameter: 22.4 mm ± 0.1 / 0.88 in. ± 0.004
- Orientation of body/fixing collar ZB5AZ009: ± 2° 30' (excluding cut-outs marked a and b).
- Tightening torque of screws ZBZ006: 0.6 N.m (5.3 lbf.in) max.
- Allow for one ZB5AZ079 fixing collar/pillar and its fixing screws:
 - every 90 mm / 3.54 in. horizontally (X), and 120 mm / 4.72 in. vertically (Y).
 - with each selector switch head (ZB5AD*, ZB5AJ*, ZB5AG*).

The fixing centers marked a and b are diagonally opposed and must align with those marked 4 and 5.



- (1) Head ZB5AD•
- (2) Panel
- (2) Nut
- (4) Printed circuit board

Mounting of Adapter (Socket) ZBZ01•

- 1 2 elongated holes for ZBZ006 screw access
- 2 1 hole \varnothing 2.4 mm \pm 0.05 / 0.09 in. \pm 0.002 for centring adapter ZBZ01•
- 3 8 \times \varnothing 1.2 mm / 0.05 in. holes
- 4 1 hole \varnothing 2.9 mm \pm 0.05 / 0.11 in. \pm 0.002, for aligning the printed circuit board (with cut-out marked **a**)
- 5 1 elongated hole for aligning the printed circuit board (with cut-out marked **b**)
- 6 4 holes \varnothing 2.4 mm / 0.09 in. for clipping in adapter ZBZ01•

Dimensions An + 18.1 relate to the \varnothing 2.4 mm \pm 0.05 / 0.09 in. \pm 0.002 holes for centring adapter ZBZ01•.

Technical Description

Electrical Composition Corresponding to Code C4



Electrical Composition Corresponding to Code C5

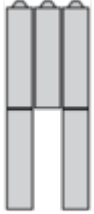

Electrical Composition Corresponding to Code C6



Electrical Composition Corresponding to Code C7



Electrical Composition Corresponding to Code C8

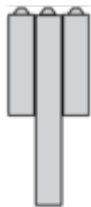

Electrical Composition Corresponding to Code C3



Electrical Composition Corresponding to Codes C9, C11, SF1 and SR1

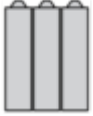

Legend

Single contact



Double contact



Light block



Possible location



Sequence of Contacts Fitted to 3-position Selector Switch Body

Position 315°



Push	Position	Top			
		Bottom			
	Location		Left	Centre	Right
	State		1	1	0
Contacts	N/O		closed	closed	open
	N/C		open	open	closed

Position 0°



Push	Position	Top			
		Bottom			
	Location		Left	Centre	Right
	State		0	0	0
Contacts	N/O		open	open	open
	N/C		closed	closed	closed

Position 45°



Push	Position	Top			
		Bottom			
	Location		Left	Centre	Right
	State		0	1	1
Contacts	N/O		open	closed	closed
	N/C		closed	open	open

Technical Illustration

Dimensions

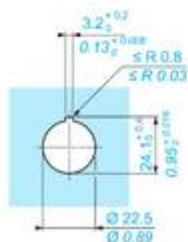
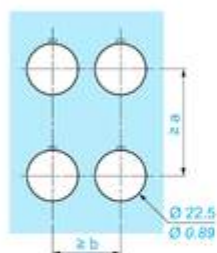
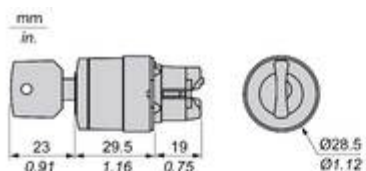

		a (mm)	a (in.)	b (mm)	b (in.)
		40	1.57	30	1.18
ZBE●●●●●	ZBV●●●●●				
		45	1.77	32	1.26
ZBE●●●●●3	ZBV●●●●●3				
		40	1.57	30	1.18
ZBE●●●●●4	ZBV●●●●●4				
		50	1.97	30	1.18
ZBE●●●●●5	ZBV●●●●●5				
		40	1.57	30	1.18
ZBE●●●●●9	ZBV●●●●●9				
		40	1.57	30	1.18
ZBRT●	ZBRV1				