

## Data Sheet | Item Number: 2020-5311/1102-950

3-conductor sensor terminal block; LED (yellow); for PNP-(high-side) switching sensors; with pluggable signal level; 1 mm<sup>2</sup>; Push-in CAGE CLAMP®; 1,00 mm<sup>2</sup>; gray

<https://www.wago.com/2020-5311/1102-950>

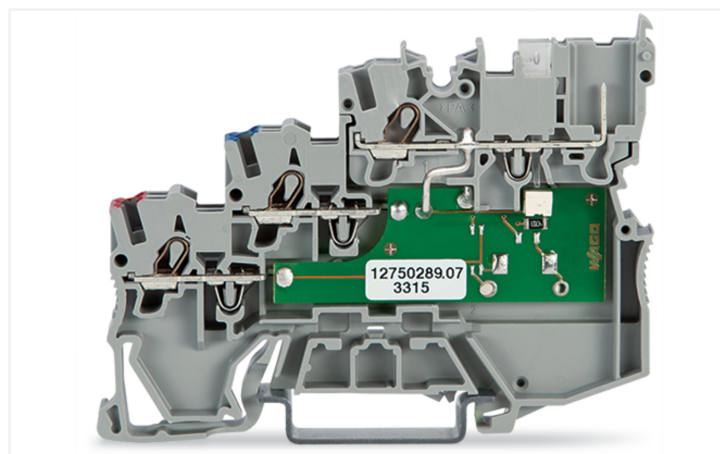
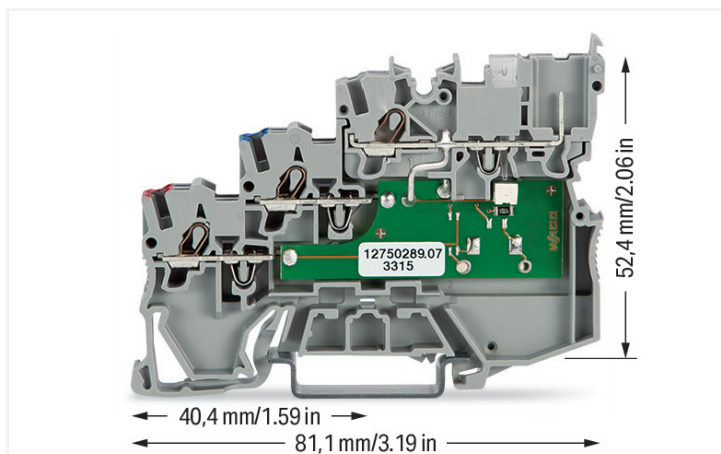

Color: ■ gray

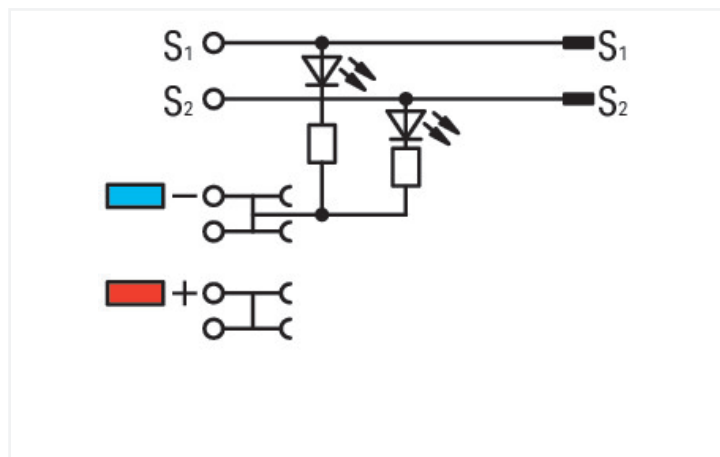
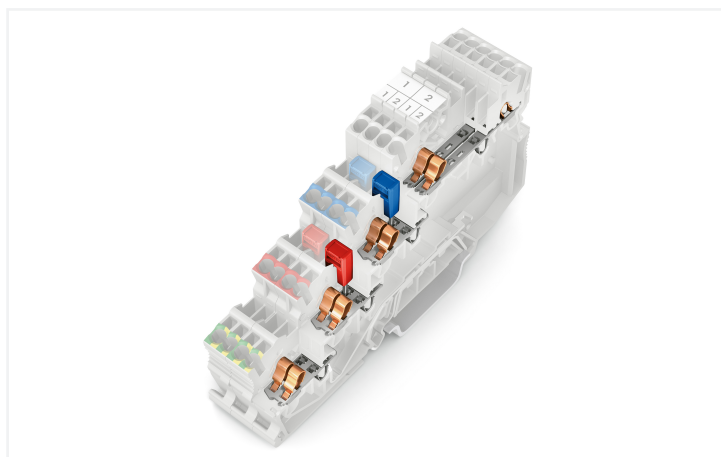

Similar to illustration

### Sensor terminal block, 2020 Series, operating tool

Seamless electrical installations are guaranteed with this sensor terminal block (item number 2020-5311/1102-950). Conductors can only be connected to this sensor terminal block if their strip length is between 9 and 11 mm. This product features conductor terminals and utilizes Push-in CAGE CLAMP®. Push-in CAGE CLAMP® technology provides a universal connection solution for all conductor types. It allows both solid and fine-stranded conductors with ferrules to be inserted directly into the clamping point without the need for tools. Depending on the conductor type, this sensor terminal block is designed for conductor cross sections ranging from 0.14 mm<sup>2</sup> to 1.5 mm<sup>2</sup>.

### Notes

Note

According to EN 61984, pluggable connectors without a current interrupting capacity must not be mated or unmated when live or under load. An appropriate end plate must be applied to the carrier terminal blocks after each female plug.

## Electrical data

Ratings per	IEC/EN 60947-7-1		
Overvoltage category	III	III	II
Pollution degree	3	2	2
Nominal voltage	-	-	-
Rated impulse withstand voltage	-	-	-
Rated current	-	-	-

Approvals per	UL 1059		
Use group	B	C	D
Rated voltage	24 V	-	300 V
Rated current	15 A	-	15 A

Approvals per	CSA 22.2 No 158		
Use group	B	C	D
Rated voltage	-	24 V	-
Rated current	-	10 A	-

Power Loss	
Power loss, per pole (potential)	0.4338 W
Rated current $I_N$ for power loss specification	13.5 A
Resistance value for specified, current-dependent power loss	0.00238 $\Omega$

## General information

Voltage type 1	DC
Nominal voltage	24 V
LED (switching) for	PNP
Number/type of diode/LED	Yellow LED
Wiring direction	Front-entry wiring

## Connection Data

Clamping units	6
Female plug slots	2
Total number of potentials	4
Number of levels	3
Number of jumper slots	3

Connection 1	
Connection technology	Push-in CAGE CLAMP®
Actuation type	Operating tool
Connectable conductor materials	Copper
Nominal cross-section	1 mm <sup>2</sup>
Solid conductor	0.14 ... 1.5 mm <sup>2</sup> / 24 ... 16 AWG
Solid conductor; push-in termination	0.5 ... 1.5 mm <sup>2</sup> / 20 ... 16 AWG
Fine-stranded conductor	0.14 ... 1.5 mm <sup>2</sup> / 24 ... 16 AWG
Fine-stranded conductor; with insulated ferrule	0.14 ... 0.75 mm <sup>2</sup> / 24 ... 18 AWG
Fine-stranded conductor; with ferrule; push-in termination	0.5 ... 0.75 mm <sup>2</sup> / 20 ... 18 AWG
Note (conductor cross-section)	Depending on the conductor characteristic, a conductor with a smaller cross-section can also be inserted via push-in termination.
Strip length	9 ... 11 mm / 0.35 ... 0.43 inches
Wiring direction	Front-entry wiring

## Physical data

Width	7 mm / 0.276 inches
Height	81.1 mm / 3.193 inches
Depth from upper-edge of DIN-rail	52.4 mm / 2.063 inches

### Mechanical data

Mounting type	DIN-35 rail
Marking level	Center/side marking

### Material data

Note (material data)	<a href="#">Information on material specifications can be found here</a>
Color	gray
Material group	I
Insulation material (main housing)	Polyamide (PA66)
Flammability class per UL94	V0
Fire load	0.339 MJ
Weight	16.8 g

### Environmental requirements

Processing temperature	-35 ... +85 °C
Continuous operating temperature	-60 ... +105 °C

### Commercial data

PU (SPU)	50 pcs
Packaging type	Box
Country of origin	DE
GTIN	4055143523516
Customs tariff number	85369010000

### Product Classification

UNSPSC	39121410
eCl@ss 10.0	27-14-11-28
eCl@ss 9.0	27-14-11-28
ETIM 9.0	EC000900
ETIM 10.0	EC000900
ECCN	NO US CLASSIFICATION

### Environmental Product Compliance

RoHS Compliance Status	Compliant, No Exemption
------------------------	-------------------------

### Approvals / Certificates

#### General approvals



Approval	Standard	Certificate Name
CCA DEKRA Certification B.V.	EN 60947	NTR NL 7617
CSA DEKRA Certification B.V.	C22.2	2516073
KEMA/KEUR DEKRA Certification B.V.	EN 60947	71-100670
UL UL International Germany GmbH	UL 1059	E 45172

#### Declarations of conformity and manufacturer's declarations

Approval	Standard	Certificate Name
EU-Declaration of Confor- mity WAGO GmbH & Co. KG	-	-
UK-Declaration of Confor- mity WAGO GmbH & Co. KG	-	-

## Downloads

### Environmental Product Compliance

#### Compliance Search

Environmental Product Compliance  
2020-5311/1102-950



## Documentation

### Bid Text

2020-5311/1102-950	19.02.2019	xml 4.13 KB	
2020-5311/1102-950	07.08.2018	docx 15.10 KB	

## CAD/CAE-Data

### CAD data

2D/3D Models  
2020-5311/1102-950



### CAE data

ZUKEN Portal  
2020-5311/1102-950



## 1 Compatible Products

### 1.1 System counterpart

#### 1.1.1 Female connector/socket



**Item No.: 2020-102**

1-conductor female connector; Push-in CAGE CLAMP®; 1.5 mm²; Pin spacing 3.5 mm; 2-pole; 1,50 mm²; gray

**Item No.: 2020-202**

2-conductor female connector; Push-in CAGE CLAMP®; 1.5 mm²; Pin spacing 3.5 mm; 2-pole; 1,50 mm²; gray

### 1.2 Required Accessories

#### 1.2.1 End plate

##### 1.2.1.1 End plate



**Item No.: 2020-5391**

End and intermediate plate; 1 mm thick; for 3-conductor terminal blocks; gray

### 1.3 Optional Accessories

#### 1.3.1 Coding

##### 1.3.1.1 Coding



**Item No.: 2020-100**

Carrier with 6 coding pins; for coding of female plugs; for carrier terminal blocks; orange

#### 1.3.2 DIN-rail

##### 1.3.2.1 Mounting accessories



**Item No.: 210-196**

Aluminum carrier rail; 35 x 8.2 mm; 1.6 mm thick; 2 m long; unslotted; similar to EN 60715; silver-colored



**Item No.: 210-198**

Copper carrier rail; 35 x 15 mm; 2.3 mm thick; 2 m long; unslotted; according to EN 60715; copper-colored



**Item No.: 210-197**

Steel carrier rail; 35 x 15 mm; 1.5 mm thick; 2 m long; slotted; similar to EN 60715; silver-colored



**Item No.: 210-114**

Steel carrier rail; 35 x 15 mm; 1.5 mm thick; 2 m long; unslotted; similar to EN 60715; silver-colored



**Item No.: 210-118**

Steel carrier rail; 35 x 15 mm; 2.3 mm thick; 2 m long; unslotted; according to EN 60715; silver-colored



**Item No.: 210-115**

Steel carrier rail; 35 x 7.5 mm; 1 mm thick; 2 m long; slotted; according to EN 60715; "Hole width 18 mm; silver-colored



**Item No.: 210-112**

Steel carrier rail; 35 x 7.5 mm; 1 mm thick; 2 m long; slotted; according to EN 60715; "Hole width 25 mm; silver-colored



**Item No.: 210-113**

Steel carrier rail; 35 x 7.5 mm; 1 mm thick; 2 m long; unslotted; according to EN 60715; silver-colored

#### 1.3.3 Ferrule

##### 1.3.3.1 Ferrule



**Item No.: 216-241**

Ferrule; Sleeve for 0.5 mm<sup>2</sup> / 20 AWG; insulated; electro-tin plated; electrolytic copper; gastight crimped; acc. to DIN 46228, Part 4/09.90; white



**Item No.: 216-242**

Ferrule; Sleeve for 0.75 mm<sup>2</sup> / 18 AWG; insulated; electro-tin plated; electrolytic copper; gastight crimped; acc. to DIN 46228, Part 4/09.90; gray



**Item No.: 216-243**

Ferrule; Sleeve for 1 mm<sup>2</sup> / AWG 18; insulated; electro-tin plated; electrolytic copper; gastight crimped; acc. to DIN 46228, Part 4/09.90; red

#### 1.3.4 Installation

##### 1.3.4.1 Cover



**Item No.: 709-156**

Cover; Type 3; suitable for cover carrier, type 3; 1 m long; transparent

##### 1.3.4.2 Cover carrier



**Item No.: 709-169**

Cover carrier; Type 3; incl. fixing/retaining screws and knurled nut; suitable for 279 to 282 and 880 Series rail-mounted terminal blocks; suitable for 264 Series miniature rail-mounted terminal blocks; suitable for 270 Series sensor and actuator terminal blocks; gray

1.3.5 Jumper

1.3.5.1 Jumper



[Item No.: 2000-406/020-000](#)  
Delta jumper; insulated; light gray



[Item No.: 2000-410/000-006](#)  
Jumper; 10-way; insulated; blue



[Item No.: 2000-410](#)  
Jumper; 10-way; insulated; light gray



[Item No.: 2000-410/000-005](#)  
Jumper; 10-way; insulated; red



[Item No.: 2000-402/000-006](#)  
Jumper; 2-way; insulated; blue



[Item No.: 2000-402](#)  
Jumper; 2-way; insulated; light gray



[Item No.: 2000-402/000-005](#)  
Jumper; 2-way; insulated; red



[Item No.: 2000-402/000-018](#)  
Jumper; 2-way; insulated; yellow-green



[Item No.: 2000-403/000-006](#)  
Jumper; 3-way; insulated; blue



[Item No.: 2000-403](#)  
Jumper; 3-way; insulated; light gray



[Item No.: 2000-403/000-005](#)  
Jumper; 3-way; insulated; red



[Item No.: 2000-404/000-006](#)  
Jumper; 4-way; insulated; blue



[Item No.: 2000-404](#)  
Jumper; 4-way; insulated; light gray



[Item No.: 2000-404/000-005](#)  
Jumper; 4-way; insulated; red



[Item No.: 2000-405/000-006](#)  
Jumper; 5-way; insulated; blue



[Item No.: 2000-405](#)  
Jumper; 5-way; insulated; light gray



[Item No.: 2000-405/000-005](#)  
Jumper; 5-way; insulated; red



[Item No.: 2000-406/000-006](#)  
Jumper; 6-way; insulated; blue



[Item No.: 2000-406](#)  
Jumper; 6-way; insulated; light gray



[Item No.: 2000-406/000-005](#)  
Jumper; 6-way; insulated; red



[Item No.: 2000-407/000-006](#)  
Jumper; 7-way; insulated; blue



[Item No.: 2000-407](#)  
Jumper; 7-way; insulated; light gray



[Item No.: 2000-407/000-005](#)  
Jumper; 7-way; insulated; red



[Item No.: 2000-408/000-006](#)  
Jumper; 8-way; insulated; blue



[Item No.: 2000-408](#)  
Jumper; 8-way; insulated; light gray



[Item No.: 2000-408/000-005](#)  
Jumper; 8-way; insulated; red



[Item No.: 2000-409/000-006](#)  
Jumper; 9-way; insulated; blue



[Item No.: 2000-409](#)  
Jumper; 9-way; insulated; light gray



[Item No.: 2000-409/000-005](#)  
Jumper; 9-way; insulated; red



[Item No.: 2000-440](#)  
Jumper; from 1 to 10; insulated; light gray



[Item No.: 2000-433/000-006](#)  
Jumper; from 1 to 3; insulated; blue



[Item No.: 2000-433](#)  
Jumper; from 1 to 3; insulated; light gray



[Item No.: 2000-433/000-005](#)  
Jumper; from 1 to 3; insulated; red



[Item No.: 2000-434](#)  
Jumper; from 1 to 4; insulated; light gray



[Item No.: 2000-435](#)  
Jumper; from 1 to 5; insulated; light gray



[Item No.: 2000-436](#)  
Jumper; from 1 to 6; insulated; light gray



[Item No.: 2000-437](#)  
Jumper; from 1 to 7; insulated; light gray



[Item No.: 2000-438](#)  
Jumper; from 1 to 8; insulated; light gray



[Item No.: 2000-439](#)  
Jumper; from 1 to 9; insulated; light gray



[Item No.: 2000-405/011-000](#)  
Star point jumper; 3-way; insulated; light gray



[Item No.: 210-103](#)  
Wire commoning chain; insulated; black

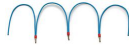

[Item No.: 210-123](#)  
Wire commoning chain; insulated; blue

1.3.6 Marking

1.3.6.1 Group marker carrier



[Item No.: 2009-191](#)  
Group marker carrier; gray

1.3.6.2 Marker



**Item No.: 793-3501**

WMB marking card; as card; plain; snap-on type; white



**Item No.: 2009-113/000-006**

WMB-Inline; for Smart Printer; 2300 pieces on roll; plain; snap-on type; blue



**Item No.: 2009-113/000-007**

WMB-Inline; for Smart Printer; 2300 pieces on roll; plain; snap-on type; gray



**Item No.: 2009-113/000-023**

WMB-Inline; for Smart Printer; 2300 pieces on roll; plain; snap-on type; green



**Item No.: 2009-113/000-017**

WMB-Inline; for Smart Printer; 2300 pieces on roll; plain; snap-on type; light green



**Item No.: 2009-113/000-012**

WMB-Inline; for Smart Printer; 2300 pieces on roll; plain; snap-on type; orange



**Item No.: 2009-113/000-005**

WMB-Inline; for Smart Printer; 2300 pieces on roll; plain; snap-on type; red



**Item No.: 2009-113/000-024**

WMB-Inline; for Smart Printer; 2300 pieces on roll; plain; snap-on type; violet



**Item No.: 2009-113**

WMB-Inline; for Smart Printer; 2300 pieces on roll; plain; snap-on type; white



**Item No.: 2009-113/000-002**

WMB-Inline; for Smart Printer; 2300 pieces on roll; plain; snap-on type; yellow

1.3.6.3 Marker carrier



**Item No.: 2000-121**

Adaptor; gray

1.3.6.4 Marking strip



**Item No.: 2009-110**

Marking strips; for Smart Printer; on reel; not stretchable; plain; snap-on type; white

1.3.7 Protective warning marker

1.3.7.1 Cover



**Item No.: 2000-115**

Protective warning marker; for 5 terminal blocks; with high-voltage symbol, black; yellow

1.3.8 Push-in type wire jumper

1.3.8.1 Jumper



**Item No.: 2009-404**

Push-in type wire jumper; 0.75 mm<sup>2</sup>; insulated; 110 mm long; gray



**Item No.: 2009-406**

Push-in type wire jumper; 0.75 mm<sup>2</sup>; insulated; 250 mm long; gray



**Item No.: 2009-402**

Push-in type wire jumper; 0.75 mm<sup>2</sup>; insulated; 60 mm long; gray

### 1.3.9 Screwless end stop

#### 1.3.9.1 Mounting accessories



**Item No.: 249-117**

Screwless end stop; 10 mm wide; for DIN-rail 35 x 15 and 35 x 7.5; gray



**Item No.: 249-116**

Screwless end stop; 6 mm wide; for DIN-rail 35 x 15 and 35 x 7.5; gray

### 1.3.10 Test and measurement

#### 1.3.10.1 Testing accessories



**Item No.: 2009-174**

Test plug adapter; for 4 mm Ø test plugs; for testing TOPJOB®S rail-mounted terminal blocks; gray



**Item No.: 2009-182**

Testing tap; for max. 2.5 mm<sup>2</sup>; tool-free connection for individual test wires 0.08 - 2.5 mm; gray

### 1.3.11 Tool

#### 1.3.11.1 Operating tool



**Item No.: 210-719**

Operating tool; Blade: 2.5 x 0.4 mm; with a partially insulated shaft



**Item No.: 210-648**

Operating tool; Blade: 2.5 x 0.4 mm; with a partially insulated shaft; angled; short



**Item No.: 210-647**

Operating tool; Blade: 2.5 x 0.4 mm; with a partially insulated shaft; multicoloured

## Installation Notes

### Installation

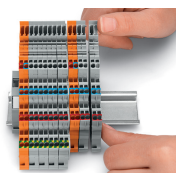

Snap individual terminal blocks onto the DIN-rail and slide together.



Separate terminal block assembly and slide individual terminal blocks laterally using an operating tool.

### Conductor termination

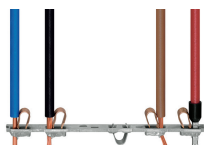

#### All conductor types at a glance

## Testing

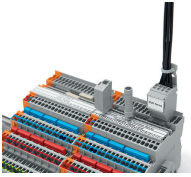

Testing via testing tap (Item No. 2009-182) or test plug adapter (Item No. 2009-174) (up to max. 42 V).

## Coding

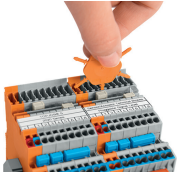

Insert coding pin into the corresponding slot and twist it off.

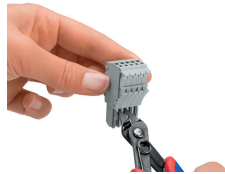

Remove the coding finger using a cutting tool.

## Locking system

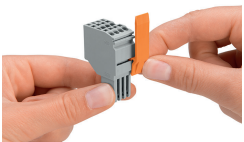

Slide the locking lever into position.

## Strain relief

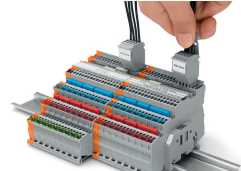
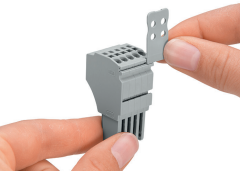

Removing a female plug via conductor bundle provided with strain relief plate.

## Marking

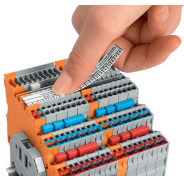

Labeling terminal blocks via marking strips (Item No. 2009-110) or 3.5 mm wide WMB markers (Item No. 793-35xx) – from the top or the side.