

Data Sheet | Item Number: 2020-5477

4-conductor sensor supply terminal block; for PNP (positive) switching sensors; with ground contact; 1 mm²; Push-in CAGE CLAMP®; 1,00 mm²; orange

<https://www.wago.com/2020-5477>

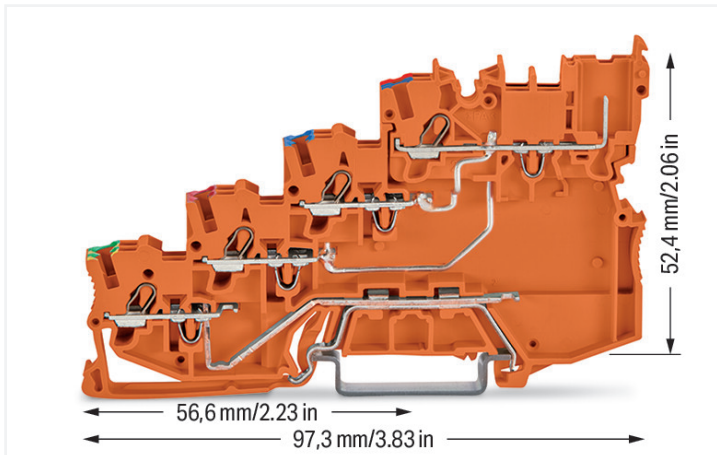

Color: ■ orange

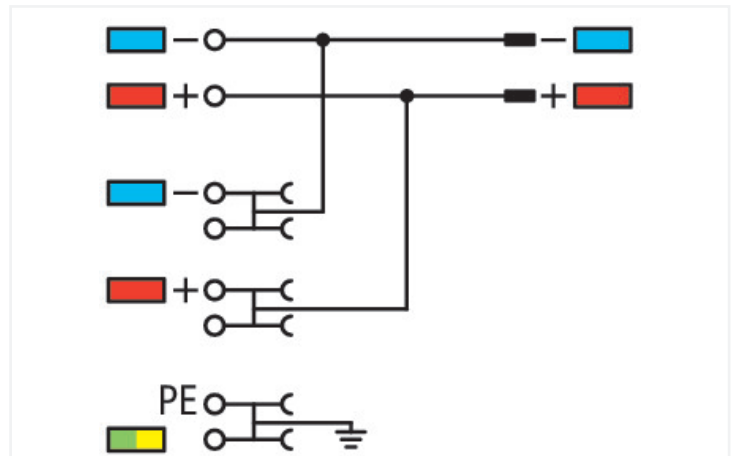
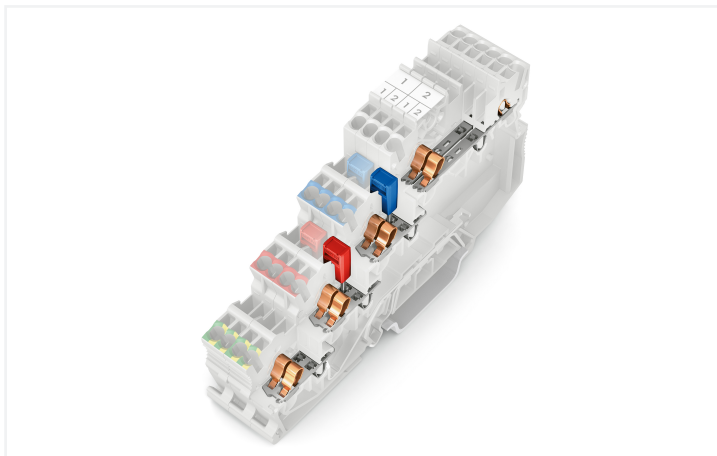

Similar to illustration

Sensor supply terminal block, 2020 Series, Push-in CAGE CLAMP®

Fault-free electrical installations are guaranteed with sensor supply terminal block (item number 2020-5477). Conductors should only be connected to sensor supply terminal block if their strip length is between 9 and 11 mm. This product incorporates conductor terminals and utilizes Push-in CAGE CLAMP®. Our Push-in CAGE CLAMP® is a universal, maintenance-free connection solution for all conductor types, offering a key advantage: It allows direct insertion of both solid and fine-stranded conductors with ferrules without needing tools. No preparation is required; for example, crimping the conductor's ferrule is not necessary. Sensor supply terminal block is suitable for conductor cross sections ranging from 0.14 mm² to 1.5 mm².

Notes

Note

According to EN 61984, pluggable connectors without a current interrupting capacity must not be mated or unmated when live or under load. An appropriate end plate must be applied to the carrier terminal blocks after each female plug.

Electrical data

| Ratings per | IEC/EN 60947-7-1 | | |
|---------------------------------|------------------|-----|----|
| Overvoltage category | III | III | II |
| Pollution degree | 3 | 2 | 2 |
| Nominal voltage | - | - | - |
| Rated impulse withstand voltage | - | - | - |
| Rated current | - | - | - |

| Approvals per | UL 1059 | | |
|---------------|---------|---|-------|
| Use group | B | C | D |
| Rated voltage | 300 V | - | 300 V |
| Rated current | 15 A | - | 15 A |

| Approvals per | CSA 22.2 No 158 | | |
|---------------|-----------------|-------|---|
| Use group | B | C | D |
| Rated voltage | - | 300 V | - |
| Rated current | - | 10 A | - |

| Power Loss | |
|--|------------------|
| Power loss, per pole (potential) | 0.4338 W |
| Rated current I_N for power loss specification | 13.5 A |
| Resistance value for specified, current-dependent power loss | 0.00238 Ω |

General information

| | |
|---------------------|--------------------|
| LED (switching) for | PNP |
| Wiring direction | Front-entry wiring |

Connection Data

| | |
|----------------------------|---|
| Clamping units | 8 |
| Female plug slots | 2 |
| Total number of potentials | 5 |
| Number of levels | 4 |
| Number of jumper slots | 5 |

| Connection 1 | |
|--|---|
| Connection technology | Push-in CAGE CLAMP® |
| Actuation type | Operating tool |
| Connectable conductor materials | Copper |
| Nominal cross-section | 1 mm ² |
| Solid conductor | 0.14 ... 1.5 mm ² / 24 ... 16 AWG |
| Solid conductor; push-in termination | 0.5 ... 1.5 mm ² / 20 ... 16 AWG |
| Fine-stranded conductor | 0.14 ... 1.5 mm ² / 24 ... 16 AWG |
| Fine-stranded conductor; with insulated ferrule | 0.14 ... 0.75 mm ² / 24 ... 18 AWG |
| Fine-stranded conductor; with ferrule; push-in termination | 0.5 ... 0.75 mm ² / 20 ... 18 AWG |
| Note (conductor cross-section) | Depending on the conductor characteristic, a conductor with a smaller cross-section can also be inserted via push-in termination. |
| Strip length | 9 ... 11 mm / 0.35 ... 0.43 inches |
| Wiring direction | Front-entry wiring |

Physical data

| | |
|-----------------------------------|------------------------|
| Width | 7 mm / 0.276 inches |
| Height | 97.3 mm / 3.831 inches |
| Depth from upper-edge of DIN-rail | 52.4 mm / 2.063 inches |

Mechanical data

| | |
|---------------|----------------|
| Mounting type | DIN-35 rail |
| Marking level | Center marking |

Material data

| | |
|------------------------------------|--|
| Note (material data) | Information on material specifications can be found here |
| Color | orange |
| Material group | I |
| Insulation material (main housing) | Polyamide (PA66) |
| Flammability class per UL94 | V0 |
| Fire load | 0.36 MJ |
| Weight | 21.5 g |

Environmental requirements

| | |
|----------------------------------|-----------------|
| Processing temperature | -35 ... +85 °C |
| Continuous operating temperature | -60 ... +105 °C |

Commercial data

| | |
|-----------------------|---------------|
| PU (SPU) | 15 pcs |
| Packaging type | Box |
| Country of origin | DE |
| GTIN | 4055143525510 |
| Customs tariff number | 85369010000 |

Product Classification

| | |
|-------------|----------------------|
| UNSPSC | 39121410 |
| eCl@ss 10.0 | 27-14-11-28 |
| eCl@ss 9.0 | 27-14-11-28 |
| ETIM 9.0 | EC000900 |
| ETIM 10.0 | EC000900 |
| ECCN | NO US CLASSIFICATION |

Environmental Product Compliance

| | |
|------------------------|-------------------------|
| RoHS Compliance Status | Compliant, No Exemption |
|------------------------|-------------------------|

Approvals / Certificates

General approvals



| Approval | Standard | Certificate Name |
|--|----------|------------------|
| CCA DEKRA Certification B.V. | EN 60947 | NTR NL 7617 |
| CSA DEKRA Certification B.V. | C22.2 | 2516073 |
| KEMA/KEUR DEKRA Certification B.V. | EN 60947 | 71-100670 |
| UL UL International Germany GmbH | UL 1059 | E 45172 |

Declarations of conformity and manufacturer's declarations

| Approval | Standard | Certificate Name |
|---|----------|------------------|
| EU-Declaration of Confor- mity WAGO GmbH & Co. KG | - | - |
| UK-Declaration of Confor- mity WAGO GmbH & Co. KG | - | - |

Downloads

Environmental Product Compliance

Compliance Search

Environmental Product Compliance 2020-5477



Documentation

Bid Text

| | | | |
|-----------|------------|------------------|--|
| 2020-5477 | 19.02.2019 | xml 4.17 KB | |
| 2020-5477 | 07.08.2018 | docx 15.16 KB | |

CAD/CAE-Data

CAD data

2D/3D Models
2020-5477



CAE data

ZUKEN Portal
2020-5477



1 Compatible Products

1.1 System counterpart

1.1.1 Female connector/socket



Item No.: 2020-102

1-conductor female connector; Push-in CAGE CLAMP®; 1.5 mm²; Pin spacing 3.5 mm; 2-pole; 1,50 mm²; gray

Item No.: 2020-202

2-conductor female connector; Push-in CAGE CLAMP®; 1.5 mm²; Pin spacing 3.5 mm; 2-pole; 1,50 mm²; gray

1.2 Required Accessories

1.2.1 End plate

1.2.1.1 End plate



Item No.: 2020-5491

End and intermediate plate; 1 mm thick; for 4-conductor terminal blocks; gray

1.3 Optional Accessories

1.3.1 Coding

1.3.1.1 Coding



Item No.: 2020-100

Carrier with 6 coding pins; for coding of female plugs; for carrier terminal blocks; orange

1.3.2 DIN-rail

1.3.2.1 Mounting accessories



Item No.: 210-196

Aluminum carrier rail; 35 x 8.2 mm; 1.6 mm thick; 2 m long; unslotted; similar to EN 60715; silver-colored



Item No.: 210-198

Copper carrier rail; 35 x 15 mm; 2.3 mm thick; 2 m long; unslotted; according to EN 60715; copper-colored



Item No.: 210-197

Steel carrier rail; 35 x 15 mm; 1.5 mm thick; 2 m long; slotted; similar to EN 60715; silver-colored



Item No.: 210-114

Steel carrier rail; 35 x 15 mm; 1.5 mm thick; 2 m long; unslotted; similar to EN 60715; silver-colored



Item No.: 210-118

Steel carrier rail; 35 x 15 mm; 2.3 mm thick; 2 m long; unslotted; according to EN 60715; silver-colored



Item No.: 210-115

Steel carrier rail; 35 x 7.5 mm; 1 mm thick; 2 m long; slotted; according to EN 60715; "Hole width 18 mm; silver-colored



Item No.: 210-112

Steel carrier rail; 35 x 7.5 mm; 1 mm thick; 2 m long; slotted; according to EN 60715; "Hole width 25 mm; silver-colored



Item No.: 210-113

Steel carrier rail; 35 x 7.5 mm; 1 mm thick; 2 m long; unslotted; according to EN 60715; silver-colored

1.3.3 Ferrule

1.3.3.1 Ferrule



Item No.: 216-241

Ferrule; Sleeve for 0.5 mm² / 20 AWG; insulated; electro-tin plated; electrolytic copper; gastight crimped; acc. to DIN 46228, Part 4/09.90; white



Item No.: 216-242

Ferrule; Sleeve for 0.75 mm² / 18 AWG; insulated; electro-tin plated; electrolytic copper; gastight crimped; acc. to DIN 46228, Part 4/09.90; gray



Item No.: 216-243

Ferrule; Sleeve for 1 mm² / AWG 18; insulated; electro-tin plated; electrolytic copper; gastight crimped; acc. to DIN 46228, Part 4/09.90; red

1.3.4 Installation

1.3.4.1 Cover



Item No.: 709-156

Cover; Type 3; suitable for cover carrier, type 3; 1 m long; transparent

1.3.4.2 Cover carrier



Item No.: 709-169

Cover carrier; Type 3; incl. fixing/retaining screws and knurled nut; suitable for 279 to 282 and 880 Series rail-mounted terminal blocks; suitable for 264 Series miniature rail-mounted terminal blocks; suitable for 270 Series sensor and actuator terminal blocks; gray

1.3.5 Jumper

1.3.5.1 Jumper



[Item No.: 2000-406/020-000](#)
Delta jumper; insulated; light gray



[Item No.: 2000-410/000-006](#)
Jumper; 10-way; insulated; blue



[Item No.: 2000-410](#)
Jumper; 10-way; insulated; light gray



[Item No.: 2000-410/000-005](#)
Jumper; 10-way; insulated; red



[Item No.: 2000-402/000-006](#)
Jumper; 2-way; insulated; blue



[Item No.: 2000-402](#)
Jumper; 2-way; insulated; light gray



[Item No.: 2000-402/000-005](#)
Jumper; 2-way; insulated; red



[Item No.: 2000-402/000-018](#)
Jumper; 2-way; insulated; yellow-green



[Item No.: 2000-403/000-006](#)
Jumper; 3-way; insulated; blue



[Item No.: 2000-403](#)
Jumper; 3-way; insulated; light gray



[Item No.: 2000-403/000-005](#)
Jumper; 3-way; insulated; red



[Item No.: 2000-404/000-006](#)
Jumper; 4-way; insulated; blue



[Item No.: 2000-404](#)
Jumper; 4-way; insulated; light gray



[Item No.: 2000-404/000-005](#)
Jumper; 4-way; insulated; red



[Item No.: 2000-405/000-006](#)
Jumper; 5-way; insulated; blue



[Item No.: 2000-405](#)
Jumper; 5-way; insulated; light gray



[Item No.: 2000-405/000-005](#)
Jumper; 5-way; insulated; red



[Item No.: 2000-406/000-006](#)
Jumper; 6-way; insulated; blue



[Item No.: 2000-406](#)
Jumper; 6-way; insulated; light gray



[Item No.: 2000-406/000-005](#)
Jumper; 6-way; insulated; red



[Item No.: 2000-407/000-006](#)
Jumper; 7-way; insulated; blue



[Item No.: 2000-407](#)
Jumper; 7-way; insulated; light gray



[Item No.: 2000-407/000-005](#)
Jumper; 7-way; insulated; red



[Item No.: 2000-408/000-006](#)
Jumper; 8-way; insulated; blue



[Item No.: 2000-408](#)
Jumper; 8-way; insulated; light gray



[Item No.: 2000-408/000-005](#)
Jumper; 8-way; insulated; red



[Item No.: 2000-409/000-006](#)
Jumper; 9-way; insulated; blue



[Item No.: 2000-409](#)
Jumper; 9-way; insulated; light gray



[Item No.: 2000-409/000-005](#)
Jumper; 9-way; insulated; red



[Item No.: 2000-440](#)
Jumper; from 1 to 10; insulated; light gray



[Item No.: 2000-433/000-006](#)
Jumper; from 1 to 3; insulated; blue



[Item No.: 2000-433](#)
Jumper; from 1 to 3; insulated; light gray



[Item No.: 2000-433/000-005](#)
Jumper; from 1 to 3; insulated; red



[Item No.: 2000-434](#)
Jumper; from 1 to 4; insulated; light gray



[Item No.: 2000-435](#)
Jumper; from 1 to 5; insulated; light gray



[Item No.: 2000-436](#)
Jumper; from 1 to 6; insulated; light gray



[Item No.: 2000-437](#)
Jumper; from 1 to 7; insulated; light gray



[Item No.: 2000-438](#)
Jumper; from 1 to 8; insulated; light gray



[Item No.: 2000-439](#)
Jumper; from 1 to 9; insulated; light gray



[Item No.: 2000-405/011-000](#)
Star point jumper; 3-way; insulated; light gray



[Item No.: 210-103](#)
Wire commoning chain; insulated; black



[Item No.: 210-123](#)
Wire commoning chain; insulated; blue

1.3.6 Marking

1.3.6.1 Group marker carrier



[Item No.: 2009-191](#)
Group marker carrier; gray

1.3.6.2 Marker



Item No.: 793-3501

WMB marking card; as card; plain; snap-on type; white



Item No.: 2009-113/000-006

WMB-Inline; for Smart Printer; 2300 pieces on roll; plain; snap-on type; blue



Item No.: 2009-113/000-007

WMB-Inline; for Smart Printer; 2300 pieces on roll; plain; snap-on type; gray



Item No.: 2009-113/000-023

WMB-Inline; for Smart Printer; 2300 pieces on roll; plain; snap-on type; green



Item No.: 2009-113/000-017

WMB-Inline; for Smart Printer; 2300 pieces on roll; plain; snap-on type; light green



Item No.: 2009-113/000-012

WMB-Inline; for Smart Printer; 2300 pieces on roll; plain; snap-on type; orange



Item No.: 2009-113/000-005

WMB-Inline; for Smart Printer; 2300 pieces on roll; plain; snap-on type; red



Item No.: 2009-113/000-024

WMB-Inline; for Smart Printer; 2300 pieces on roll; plain; snap-on type; violet



Item No.: 2009-113

WMB-Inline; for Smart Printer; 2300 pieces on roll; plain; snap-on type; white



Item No.: 2009-113/000-002

WMB-Inline; for Smart Printer; 2300 pieces on roll; plain; snap-on type; yellow

1.3.6.3 Marker carrier



Item No.: 2000-121

Adaptor; gray

1.3.6.4 Marking strip



Item No.: 2009-110

Marking strips; for Smart Printer; on reel; not stretchable; plain; snap-on type; white

1.3.7 Protective warning marker

1.3.7.1 Cover



Item No.: 2000-115

Protective warning marker; for 5 terminal blocks; with high-voltage symbol, black; yellow

1.3.8 Push-in type wire jumper

1.3.8.1 Jumper



Item No.: 2009-404

Push-in type wire jumper; 0.75 mm²; insulated; 110 mm long; gray



Item No.: 2009-406

Push-in type wire jumper; 0.75 mm²; insulated; 250 mm long; gray



Item No.: 2009-402

Push-in type wire jumper; 0.75 mm²; insulated; 60 mm long; gray

1.3.9 Screwless end stop

1.3.9.1 Mounting accessories



Item No.: 249-117

Screwless end stop; 10 mm wide; for DIN-rail 35 x 15 and 35 x 7.5; gray



Item No.: 249-116

Screwless end stop; 6 mm wide; for DIN-rail 35 x 15 and 35 x 7.5; gray

1.3.10 Test and measurement

1.3.10.1 Testing accessories



Item No.: 2009-174

Test plug adapter; for 4 mm Ø test plugs; for testing TOPJOB®S rail-mounted terminal blocks; gray



Item No.: 2009-182

Testing tap; for max. 2.5 mm²; tool-free connection for individual test wires 0.08 - 2.5 mm; gray

1.3.11 Tool

1.3.11.1 Operating tool



Item No.: 210-719

Operating tool; Blade: 2.5 x 0.4 mm; with a partially insulated shaft



Item No.: 210-648

Operating tool; Blade: 2.5 x 0.4 mm; with a partially insulated shaft; angled; short



Item No.: 210-647

Operating tool; Blade: 2.5 x 0.4 mm; with a partially insulated shaft; multicoloured

Installation Notes

Installation

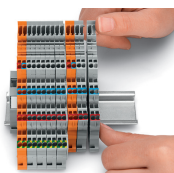

Snap individual terminal blocks onto the DIN-rail and slide together.



Separate terminal block assembly and slide individual terminal blocks laterally using an operating tool.

Conductor termination

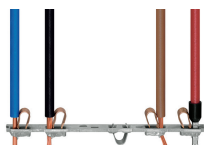

All conductor types at a glance

Testing

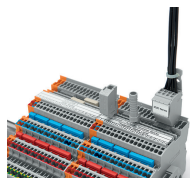

Testing via testing tap (Item No. 2009-182) or test plug adapter (Item No. 2009-174) (up to max. 42 V).

Coding

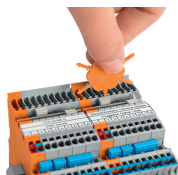

Insert coding pin into the corresponding slot and twist it off.

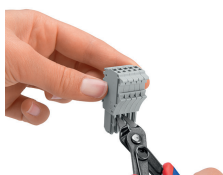

Remove the coding finger using a cutting tool.

Locking system

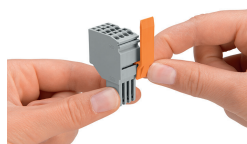

Slide the locking lever into position.

Strain relief

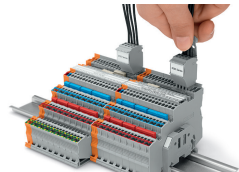
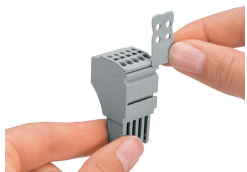

Removing a female plug via conductor bundle provided with strain relief plate.

Marking

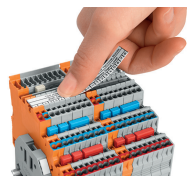

Labeling terminal blocks via marking strips (Item No. 2009-110) or 3.5 mm wide WMB markers (Item No. 793-35xx) – from the top or the side.