

Product: **elko-san
San 300**

Type: **EVSAN300**
Datum: **15-1-2024**

Klantnaam:

Project:

Referentie:

Tekening

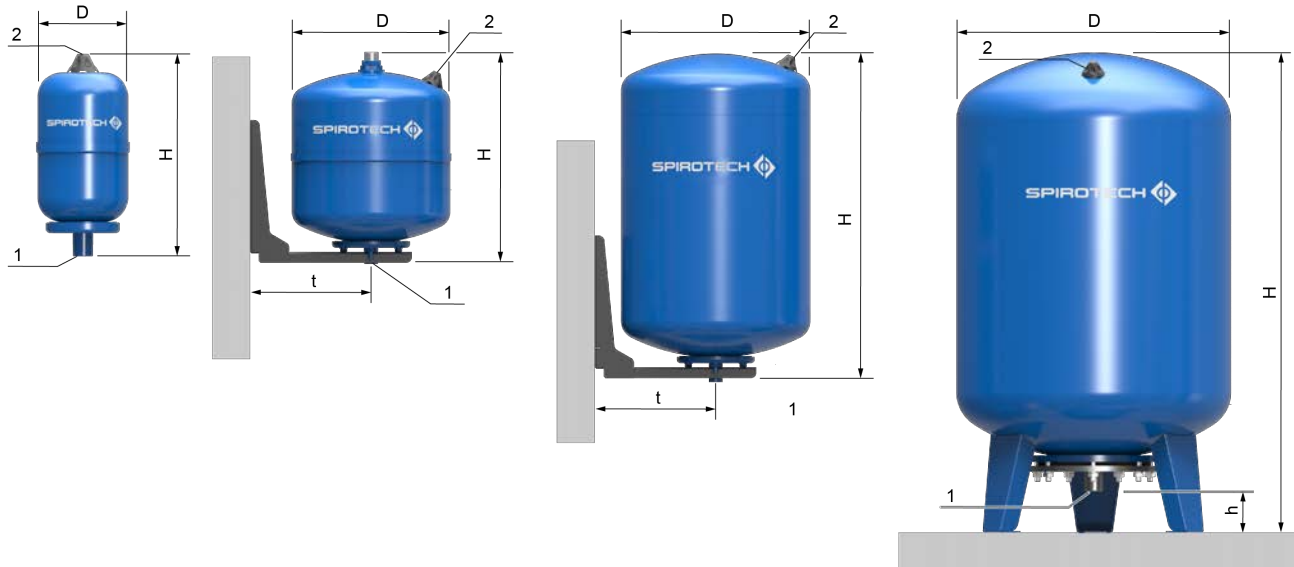

EVSan 2

EVSan 15 .. EVSan 60

EVSan 60

EVSan 120 .. EVSan 300

Ontwerp criteria

Tested in accordance with:	PED 2014/68/EU	
Max. safety temperature of the system without/with cooling vessel:	90/110	°C
Minimale temperatuur:	0	°C
Maximale temperatuur:	70	°C
Maximale systeemdruk:	10	bar-g
Permissible medium:	Water, Water/Glycol	
Kleur:	RAL 5015	

Afmetingen

D:	600 mm
H:	1400 mm
h:	80 mm
t:	80 mm
Connection	R1
1	Expansion pipe
2	Gas pressure valve
Volume:	300 ltr
Ledig gewicht (circa):	84 kg

Wijzigingen voorbehouden